

Errata

Title & Document Type: 4195A Spectrum Network/Analyzer Maintenance Manual

Manual Part Number: 04195-90100

Revision Date: November 1989

HP References in this Manual

This manual may contain references to HP or Hewlett-Packard. Please note that Hewlett-Packard's former test and measurement, semiconductor products and chemical analysis businesses are now part of Agilent Technologies. We have made no changes to this manual copy. The HP XXXX referred to in this document is now the Agilent XXXX. For example, model number HP8648A is now model number Agilent 8648A.

About this Manual

We've added this manual to the Agilent website in an effort to help you support your product. This manual provides the best information we could find. It may be incomplete or contain dated information, and the scan quality may not be ideal. If we find a better copy in the future, we will add it to the Agilent website.

Support for Your Product

Agilent no longer sells or supports this product. You will find any other available product information on the Agilent Test & Measurement website:

www.tm.agilent.com

Search for the model number of this product, and the resulting product page will guide you to any available information. Our service centers may be able to perform calibration if no repair parts are needed, but no other support from Agilent is available.

MANUAL CHANGES

HP 4195A

Network/Spectrum Analyzer

MANUAL IDENTIFICATION

Model Number: HP 4195A
Date Printed: November 1989
Part Number: 04195-90100

This supplement contains information for correcting manual errors and for adapting the manual to newer instruments that contain improvements or modifications not documented in the existing manual.

To use this supplement

1. Make all ERRATA corrections
2. Make all appropriate serial-number-related changes listed below

SERIAL PREFIX OR NUMBER MAKE MANUAL CHANGES

SERIAL PREFIX OR NUMBER	MAKE MANUAL CHANGES
ALL	1

SERIAL PREFIX OR NUMBER MAKE MANUAL CHANGES

SERIAL PREFIX OR NUMBER	MAKE MANUAL CHANGES

► New Item

CHANGE 1

- Section 2. PERFORMANCE TESTS, Page 2-22, Paragraph 2-14. LEVEL ACCURACY/FLATNESS TEST

Change Level Flatness Specification to ± 2.9 dB (from ± 1.5 dB).

- Section 2. PERFORMANCE TESTS, Pages 6 and 7 of PERFORMANCE TEST RECORD

Change the Flatness test limits to ± 2.9 dB (from ± 1.5 dB).

NOTE

Manual change supplements are revised as often as necessary to keep manuals as current and accurate as possible. Hewlett-Packard recommends that you periodically request the latest edition of this supplement. Free copies are available from all HP offices. When requesting copies, quote the manual identification information from your supplement, or the model number and print date from the title page of the manual.

Date/Div: April 1990/33

Page: 1 of 1





MAINTENANCE MANUAL

MODEL 4195A

NETWORK/SPECTRUM

ANALYZER

(Including Option 001)

SERIAL NUMBERS

This manual applies directly to instruments whose serial number prefix is as follows.

2904A with ROM-based firmware revision 2.00
2904J with ROM-based firmware revision 2.00

With changes described in APPENDIX A, this manual also applies to instruments whose serial number prefix is 2830J and below, or whose ROM-based firmware is revision 1.02 and below.

For additional important information about serial numbers, read SERIAL NUMBER in Section 7 of the Operation Manual.

© COPYRIGHT: YOKOGAWA-HEWLETT-PACKARD, LTD., 1988
9-1, TAKAKURA-CHO, HACHIOJI-SHI, TOKYO, JAPAN

Manual Part Number: 04195-90100
Microfiche Part Number: 04195-90150

Printed: November 1989

MANUAL PRINTING HISTORY

March 1988	First Edition	This manual is the first edition Maintenance Manual for the HP 4195A Network/Spectrum Analyzer.
December 1988	Second Edition	Specification changes as of December 1988.
November 1989	Third Edition	Adjustment procedure changes.

HOW TO USE THIS MANUAL

This Maintenance Manual for HP Model 4195A Network/Spectrum Analyzer includes the information necessary to maintain the HP 4195A's performance. This manual contains three sections and appendices, as follows.

Section 1, General Information

Section 1 includes the required equipment list, and information necessary for you to know before you perform the performance tests, and adjustments. This section should be read before performing tests and adjustments.

Section 2, Performance Tests

Section 2 is the performance test instruction necessary to confirm that the HP 4195A satisfies the specifications given in Section 7 of the Operation Manual. This section should be referred to for periodical performance checks, and for verification test after repair.

Section 3, Adjustments

Section 3 is the adjustment instruction necessary to adjust the HP 4195A so that it meets specifications. This section should be referred to when the 4195A fails the performance tests, or after repair.

Appendices

Appendix A is the **Manual Backdating** and provides information to use this manual with a 4195A which was manufactured before the printing date of the manual. Appendix B provides the board assembly list, and Appendix C provides the board assembly locations to locate the board assembly.

CERTIFICATION

Hewlett-Packard Company certifies that this product met its published specifications at the time of shipment from the factory. Hewlett-Packard further certifies that its calibration measurements are traceable to the United States National Bureau of Standards, to the extent allowed by the Bureau's calibration facility, and to the calibration facilities of other International Standards Organization members.

WARRANTY

This Hewlett-Packard instrument product is warranted against defects in material and workmanship for a period of one year from the date of shipment, except that in the case of certain components listed in Section 7 of Operation Manual, the warranty shall be for the specified period. During the warranty period, Hewlett-Packard Company will, at its option, either repair or replace products which prove to be defective.

For warranty service or repair, this product must be returned to a service facility designated by HP. Buyer shall prepay shipping charges to HP and HP shall pay shipping charges to return the product to Buyer. However, Buyer shall pay all shipping charges, duties, and taxes for products returned to HP from another country.

HP warrants that its software and firmware designated by HP for use with an instrument will execute its programming instruction when properly installed on that instrument. HP does not warrant that the operation of the instrument, or software, or firmware will be uninterrupted or error free.

LIMITATION OF WARRANTY

The foregoing warranty shall not apply to defects resulting from improper or inadequate maintenance by Buyer, Buyer-supplied software or interfacing, unauthorized modification or misuse, operation outside of the environment specifications for the product, or improper site preparation or maintenance.

NO OTHER WARRANTY IS EXPRESSED OR IMPLIED. HP SPECIFICALLY DISCLAIMS THE IMPLIED WARRANTIES OF MERCHANTABILITY AND FITNESS FOR A PARTICULAR PURPOSE.

EXCLUSIVE REMEDIES

THE REMEDIES PROVIDED HEREIN ARE BUYER'S SOLE AND EXCLUSIVE REMEDIES. HP SHALL NOT BE LIABLE FOR ANY DIRECT, INDIRECT, SPECIAL, TRACT, TORT, OR ANY OTHER LEGAL THEORY.

ASSISTANCE

Product maintenance agreements and other customer assistance agreements are available for Hewlett-Packard products.

For any assistance, contact your nearest Hewlett-Packard Sales and Service Office. Address are provided at the back of this manual.

SAFETY SUMMARY

The following general safety precautions must be observed during all phases of operation, service, and repair of this instrument. Failure to comply with these precautions or with specific **WARNINGS** given elsewhere in this manual violates safety standards of design, manufacture, and intended use of the instrument. **The Hewlett-Packard Company assumes no liability for the customer's failure to comply with these requirements.**

GROUND THE INSTRUMENT

To minimize shock hazards, the instrument chassis and cabinet must be connected to an electrical ground. The instrument is equipped with a three-conductor AC power cable. The power cable must be plugged into an approved three-contact electrical outlet or used with a three-contact to two-contact adapter with the grounding wire (**green**) firmly connected to an electrical ground (safety ground) at the power outlet. The power jack and the mating plug of the power cable meet International Electrotechnical Commission (IEC) safety standards.

DO NOT OPERATE IN AN EXPLOSIVE ATMOSPHERE

Do not operate the instrument in the presence of flammable gasses or fumes. Operation of any electrical instrument in such an environment constitutes a safety hazard.

KEEP AWAY FROM LIVE CIRCUITS

Operating personnel must not remove instrument covers. Component replacement and internal adjustments must be made by qualified maintenance personnel. Do not replace components with power cable connected. Under certain conditions, dangerous voltages may exist even with the power cable removed. To avoid injuries, always disconnect power and discharge circuits before touching them.

DO NOT SERVICE OR ADJUST ALONE

Do not attempt internal service or adjustment unless another person, capable of rendering first aid and resuscitation, is present.

USE CAUTION WHEN EXPOSING OR HANDLING THE CRT

Breakage of the cathode-ray tube (CRT) causes a high velocity scattering of glass fragments (implosion). To prevent CRT implosion, avoid rough handling or jarring of the instrument. Handling of the CRT shall be done only by qualified maintenance personnel using approved safety mask and gloves.

DO NOT SUBSTITUTE PARTS OR MODIFY INSTRUMENT

Because of the danger of introducing additional hazards, do not substitute parts or perform unauthorized modifications to the instrument. Return the instrument to a Hewlett-Packard Sales and Service Office for service and repair to ensure the safety features are maintained.

DANGEROUS PROCEDURE WARNINGS

WARNINGS, such as the example below, precede potentially dangerous procedures throughout this manual. Instructions contained in the warnings must be followed.

WARNING

DANGEROUS VOLTAGES, CAPABLE OF CAUSING DEATH, ARE PRESENT IN THIS INSTRUMENT. USE EXTREME CAUTION WHEN HANDLING, TESTING, AND ADJUSTING THIS INSTRUMENT.

SAFETY SYMBOLS

General Definitions of Safety Symbols Used On Equipment or In Manuals.



Instruction manual symbol: the product will be marked with this symbol when it is necessary for the user to refer to the instruction manual in order to protect against damage to the instrument.



Indicates dangerous voltage (terminals fed from the interior by voltage exceeding 1000 volts must be so marked).

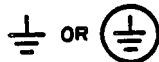

Protective conductor terminal. For protection against electrical shock in case of a fault. Used with wiring terminals to indicate the terminal which must be connected to ground before operating equipment.



Low-noise or noiseless, clean ground (earth) terminal. Used for a signal common, as well as providing protection against electrical shock in case of fault. A terminal marked with this symbol must be connected to ground in the manner described in the installation (Operating) manual, and before operating the equipment.

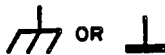

Frame or chassis terminal. A connection to the frame (chassis) of the equipment which normally includes all exposed metal structures.



Alternating current (power line).



Direct current (power line).



Alternating or direct current (power line).



A **WARNING** denotes a hazard. It calls attention to a procedure, practice, condition or the like, which, if not correctly performed or adhered to, could result in injury or death to personnel.



A **CAUTION** sign denotes a hazard. It calls attention to a procedure, practice, condition or the like, which, if not correctly performed or adhered to, could result damage to or destruction of part or all of the product.

NOTE

A **NOTE** denotes important information. It calls attention to a procedure, practice, condition or the like, which is essential to highlight.

TABLE OF CONTENTS

SECTION 1 GENERAL INFORMATION

1-1.	INTRODUCTION	1-1
1-2.	REQUIRED EQUIPMENT	1-1
1-3.	PREPARATION FOR PERFORMANCE TEST/ADJUSTMENT	1-5
1-3-1.	SET THE LINE VOLTAGE SELECTION SWITCH	1-5
1-3-2.	WARMING UP THE HP 4195A	1-5
1-3-3.	EXPRESSION FOR THE KEYS AND SOFTKEYS IN THIS MANUAL	1-5
1-3-4.	INITIALIZING THE 4195A	1-5
1-3-5.	HOW TO SET UP THE 4195A	1-6
1-3-6.	USER PROGRAM (AUTO SEQUENCE PROGRAM)	1-7
1-3-7.	HOW TO READ 4195A MEASUREMENT DATA	1-7
1-4.	INTERCONNECTION CABLES	1-8

SECTION 2 PERFORMANCE TESTS

2-1.	INTRODUCTION	2-1
2-2.	PERFORMANCE TEST RECORD	2-1
2-3.	CALCULATION SHEET	2-1
2-4.	CALIBRATION CYCLE	2-2
2-6.	INTERNAL SYNTHESIZER FREQUENCY ACCURACY TEST	2-3
2-7.	RESOLUTION BAND WIDTH ACCURACY TEST	2-5
2-8.	AMPLITUDE MEASUREMENT ACCURACY TEST	2-7
2-9.	AMPLITUDE MEASUREMENT LINEARITY TEST	2-10
2-10.	AMPLITUDE MEASUREMENT FREQUENCY RESPONSE TEST	2-12
2-11.	SECOND HARMONIC DISTORTION TEST	2-15
2-12.	THIRD ORDER INTERMODULATION DISTORTION TEST	2-17
2-13.	RESIDUAL RESPONSE TEST	2-20
2-14.	LEVEL ACCURACY/FLATNESS TEST	2-22

Table of Contents

2-15. NON-SWEEP LINEARITY TEST	2-24
2-16. POWER SWEEP LINEARITY TEST	2-26
2-17. SECOND HARMONICS TEST	2-28
2-18. NON-HARMONIC SPURIOUS TEST	2-30
2-19. PHASE NOISE TEST	2-32
2-20. CROSSTALK TEST	2-34
2-21. MAGNITUDE RATIO/PHASE DYNAMIC ACCURACY TEST	2-36
2-22. MAGNITUDE RATIO/PHASE FREQUENCY RESPONSE TEST	2-39
2-23. DC SOURCE VOLTAGE ACCURACY TEST	2-43

CALCULATION SHEET

PERFORMANCE TEST RECORD

SECTION 3 ADJUSTMENTS

3-1. INTRODUCTION	3-1
3-2. SAFETY CONSIDERATIONS	3-1
3-3. ADJUSTABLE AND FACTORY SELECTED COMPONENTS	3-2
3-4. ADJUSTMENT INTERACTIONS	3-2
3-5. ADJUSTMENT LOCATIONS	3-2
3-6. PREPARATION FOR ADJUSTMENT	3-2
3-6-1. CONSTRUCTION OF ADJUSTMENT INSTRUCTION	3-3
3-6-2. SERVICE FUNCTION	3-3
3-6-3. EXTERNAL REFERENCE	3-3
3-7. SPECIAL DEVICE FOR ADJUSTMENT	3-3
3-8. SWITCHING POWER SUPPLY ADJUSTMENTS	3-10
3-8-1. SWITCHING FREQUENCY ADJUSTMENT	3-10
3-8-2. OUTPUT VOLTAGE ADJUSTMENT	3-12
3-9. HIGH STABILITY OSCILLATOR ADJUSTMENTS (OPT. 001 ONLY)	3-14
3-9-1. SUPPLY VOLTAGE ADJUSTMENT	3-14
3-9-2. HIGH STABILITY OSCILLATOR FREQUENCY ADJUSTMENT	3-15

3-10. CRT DISPLAY ADJUSTMENTS	3-17
3-10-1. CRT DISPLAY SECTION REMOVAL	3-17
3-10-2. LOCAL VOLTAGE REGULATOR ADJUSTMENT	3-18
3-10-3. VERTICAL HOLD ADJUSTMENT	3-20
3-10-4. DISPLAY ADJUSTMENT	3-21
3-10-5. HORIZONTAL POSITION COARSE ADJUSTMENT	3-23
3-10-6. CRT CUTOFF ADJUSTMENT	3-24
3-10-7. WHITE BALANCE ADJUSTMENT	3-27
3-10-8. MAXIMUM INTENSITY ADJUSTMENT	3-28
3-10-9. FOCUS, CONVERGENCE, AND INTENSITY ADJUSTMENT	3-29
3-11. FREQUENCY GENERATOR ADJUSTMENTS	3-32
3-11-1. 80MHz REFERENCE SOURCE LEVEL ADJUSTMENT	3-32
3-11-2. 80MHz REFERENCE SOURCE FREQUENCY ADJUSTMENT	3-33
3-12. VCO OUTPUT SPURIOUS REJECTION ADJUSTMENTS	3-36
3-12-1. 100kHz SPURIOUS REJECTION ADJUSTMENT	3-36
3-12-2. API ADJUSTMENTS	3-38
3-12-3. 160MHz SPURIOUS REJECTION ADJUSTMENT	3-44
3-13. REFERENCE FREQUENCY CONVERTER ADJUSTMENTS	3-46
3-13-1. 80 MHz REFERENCE SIGNAL LEVEL ADJUSTMENT	3-46
3-13-2. 160 MHz BAND PASS FILTER AND REFERENCE SIGNAL LEVEL ADJUSTMENTS	3-47
3-14. AC OVERLOAD DETECTOR ADJUSTMENTS	3-49
3-14-1. LF AC OVERLOAD DETECTOR ADJUSTMENTS	3-49
3-14-2. HF AC OVERLOAD DETECTOR ADJUSTMENTS	3-51
3-15. RECEIVER INPUT FILTER ADJUSTMENTS	3-53
3-15-1. 150 MHz - 225 MHz VOLTAGE TUNED BPF ADJUSTMENT	3-53
3-15-2. 225 MHz - 340 MHz VOLTAGE TUNED BPF ADJUSTMENT	3-56
3-15-3. 340 MHz - 500 MHz VOLTAGE TUNED BPF ADJUSTMENT	3-59
3-16. RECEIVER FIRST IF CONVERTER ADJUSTMENTS	3-62
3-16-1. FIRST IF CONVERTER 86.6 MHz BPF ADJUSTMENT	3-62
3-16-2. FIRST IF CONVERTER 246 MHz BPF ADJUSTMENT	3-65
3-16-3. FIRST IF CONVERTER 86.6 MHz LEVEL ADJUSTMENT	3-67
3-16-4. FIRST IF CONVERTER 246 MHz LEVEL ADJUSTMENT	3-69
3-16-5. FIRST IF CONVERTER LOCAL LEAK ADJUSTMENT	3-71

3-17.	RECEIVER SECOND IF CONVERTER ADJUSTMENTS	3-73
3-17-1.	SECOND IF CONVERTER 246 MHz BPF ADJUSTMENT	3-73
3-17-2.	SECOND IF CONVERTER 86.6 MHz BPF ADJUSTMENT	3-75
3-17-3.	SECOND IF CONVERTER LEVEL ADJUSTMENT	3-78
3-18.	RECEIVER THIRD IF CONVERTER ADJUSTMENTS	3-81
3-18-1.	THIRD IF CONVERTER 86.6 MHz BPF ADJUSTMENT	3-81
3-18-2.	THIRD IF CONVERTER 6.3/6.9 MHz BPF ADJUSTMENTS	3-83
3-18-3.	20 dB AMPLIFIER GAIN/PHASE ADJUSTMENT	3-86
3-18-4.	THIRD IF CONVERTER 6.6 MHz LEVEL ADJUSTMENT	3-88
3-18-5.	10 dB AMPLIFIER GAIN ADJUSTMENT	3-90
3-19.	SOURCE SECOND/THIRD IF CONVERTER ADJUSTMENTS	3-93
3-19-1.	SECOND IF CONVERTER FIRST 86.6 MHz BPF ADJUSTMENT	3-93
3-19-2.	SECOND IF CONVERTER SECOND 86.6 MHz BPF ADJUSTMENT	3-95
3-19-3.	THIRD IF CONVERTER 346 MHz BPF ADJUSTMENT	3-97
3-19-4.	THIRD IF CONVERTER 86.6 MHz BPF ADJUSTMENT	3-99
3-19-5.	SECOND/THIRD IF CONVERTER GAIN ADJUSTMENT	3-101
3-20.	SOURCE FIRST IF CONVERTER ADJUSTMENTS	3-105
3-20-1.	FIRST IF CONVERTER BAND PASS FILTER ADJUSTMENT	3-105
3-20-2.	FIRST IF CONVERTER GAIN ADJUSTMENT	3-107
3-21.	SOURCE OUTPUT FILTER ADJUSTMENTS	3-110
3-21-1.	150 MHz - 225 MHz VOLTAGE TUNED BPF ADJUSTMENT	3-110
3-21-2.	225 MHz - 340 MHz VOLTAGE TUNED BPF ADJUSTMENT	3-114
3-21-3.	340 MHz - 500 MHz VOLTAGE TUNED BPF ADJUSTMENT	3-116
3-22.	SOURCE POWER AMPLIFIER ADJUSTMENTS	3-120
3-22-1.	POWER AMPLIFIER DC OFFSET ADJUSTMENTS	3-120
3-22-2.	POWER AMPLIFIER GAIN ADJUSTMENTS	3-122
3-23.	SOURCE DC BIAS VOLTAGE ADJUSTMENTS	3-124
3-24.	PHASE DETECTOR TRACKING ADJUSTMENTS	3-126
3-25.	CALIBRATION DATA UPDATING	3-128
3-25-1.	HP-IB CONTROLLER PREPARATION	3-128
3-25-2.	RECEIVER BPF TUNING VOLTAGE CALIBRATION DATA UPDATING	3-131
3-25-3.	FIRST IF CONVERTER OUTPUT LEVEL FINE ADJUSTMENT	3-132
3-25-4.	RECEIVER FREQUENCY RESPONSE CALIBRATION DATA UPDATING	3-134
3-25-5.	SOURCE BPF TUNING VOLTAGE CALIBRATION DATA UPDATING	3-136
3-25-6.	SIGNAL SOURCE GAIN ADJUSTMENT	3-137
3-25-7.	SIGNAL SOURCE AMPLITUDE CALIBRATION DATA UPDATING	3-139
3-25-8.	SIGNAL SOURCE LINEARITY CALIBRATION DATA UPDATING	3-140
3-25-9.	SIGNAL SOURCE FLATNESS CALIBRATION DATA UPDATING	3-141
3-25-10.	EXITING THE ADJUSTMENT PROGRAM	3-141

APPECDIX A MANUAL BACKDATING	A-1
APPENDIX B BOARD ASSEMBLY LIST	B-1
APPENDIX C BOARD ASSEMBLY LOCATIONS	C-1

SECTION 1

GENERAL INFORMATION

1-1. INTRODUCTION

This manual provides the information to maintain the HP 4195A; the Performance Test, and Adjustment procedures. The performance test should be performed during the periodical performance check, or when confirming the HP 4195A meets specified performance requirements after being repaired or adjusted. The HP 4195A adjustments should be performed when the HP 4195A fails the performance test, or after being repaired. This section provides a list of the equipment required to do the performance test and adjustment, and the information you must know before performing any tests and adjustments.

1-2. REQUIRED EQUIPMENT

Table 1-1 lists the equipment required to do the performance tests and adjustments. Use only calibrated test instruments when performance testing the HP 4195A. If the recommended test equipment is not available, equipment with specifications that equal or surpass those of the recommended equipment may be used.

NOTE

Components used as standards must be (1) calibrated using an instrument whose specifications are traceable to the National Bureau of Standards (NBS) or to an equivalent standards group, or (2) calibrated directly by an authorized calibration organization such as NBS. The calibration cycle depends on the stability specifications of each component.

Table 1-1. Required Equipment (sheet 1 of 3)

Equipment	Critical Specifications	Recommended Model	Qty	Use ¹
Series 200 Controller	No Substitute	HP 9826 or HP 9836	1	A
Spectrum Analyzer	Frequency Range: 1M to 1GHz Amplitude Accuracy: $\leq \pm 1\text{dB}$	HP 8568B	1	P A
Power Meter	No Substitute	HP 436A Opt. 022 or HP 438A	1	P A
Power Sensor	Freq. Range: 100k to 500MHz Power Range: 1 μ to 10mW Impedance: 50 Ω	HP 8482A	1	P A
Digital Voltmeter	DCV and ACV measurement Freq. Range: > 100kHz ACV dBm reading	HP 3456A	1	P A
Signal Generator	No Substitute	HP 8656B, HP 8482A or HP 8482B	2 1	P A
Frequency Counter	Maximum Frequency: > 500MHz Accuracy: < 0.25 ppm	HP 5385A Opt. 004	1	P A
Network Analyzer	Freq. Range: 10M to 500MHz Dynamic Accuracy: $\leq 0.05\text{dB}$ Scale Resolution: 0.1dB/Div.	HP 8753A	1	A
Oscilloscope	Vertical: 10mV/Div. Horizontal: 5ms/Div.	HP 54111D	1	A
Power Splitter	Freq. Range: >500MHz Two outputs	HP 11667A	1 2	P A
Coaxial Step Attenuator	Atten.: 0 to 80dB, 10dB step VSWR: < 1.02 Calibration Uncertainty: < ± 0.006 dB (10 to 40dB) < ± 0.015 dB (50 to 80dB) (Calibrated at 50 MHz)	HP 8496A or HP 8496G w/Opt. 001 & Opt. H60 ²	1	P A
Coaxial Loads	Termination, 50 Ω , N(m) Feedthrough, 50 Ω BNC(m)-BNC(f)	HP 909C Opt. 012 PN 04192-61002 or HP 11048C	1 1	P A P
Filter	Lowpass, Cutoff Freq.: 50MHz BNC(m)-BNC(f)	PN 0955-0306	1	P

Table 1-1. Required Equipment (sheet 2 of 3)

Equipment	Critical Specifications	Recommended Model	Qty	Use ¹
Signal Combiner	(Used to sum two RF signal)	PN 41952-65001 (included in HP 41952A)	1	P
Double Balanced Mixer	Freq. Range: 500MHz	HP 10514A	1	A
Attenuator Pad	Impedance 50 Ω, N(m)-N(f) Att 3dB Att 6dB Att 10dB Att 6dB, VSWR < 1.015 Att 10dB, VSWR < 1.015	HP 8491A Opt. 003	3	A
		HP 8491A Opt. 006	1	P
		HP 8491A Opt. 010	1	P
		HP 8491A w/Opt. 006 & Opt. H60 ³	1	P
		HP 8491A w/Opt. 010 & Opt. H60 ³	1	P
Probes	10:1, 1MΩ, Max. Input: >200V	HP 10040A	1	A
	Impedance: > 500 Ω at 250MHz	HP 10020A	1	A
Cables	HP-IB	HP 10833A/B/C	3	A
	Coaxial, 50Ω N(m)-N(m), 61cm BNC(m)-BNC(m), 30cm BNC(m)-BNC(m), 61cm	HP 11500B	3	P A
		PN 8120-1838	2	A
		PN 8120-1839	1	P A
	BNC(m)-BNC(m), 122cm	PN 8120-1840 or HP 10503A	3 2	A P A
Test Leads	Alligator Clips to Dual Banana Plug	HP 11002A	1	A
Adapters	Coaxial, 50Ω N(f)-N(f) N(f)-BNC(f) N(m)-N(m)	PN 1250-0777	1	P
		PN 1250-1474	1	P A
		PN 1250-0778	1	P
			2	A
	N(m)-BNC(f)	PN 1250-0780	1	P
	N(f)-BNC(m)	PN 1250-0077	3	A
		1	P	
	BNC(m)-BNC(f), Right Angle	PN 1250-0076	3	A
		1	A	
	BNC(f)-SMB(f)	PN 1250-1236	4	A
	BNC(f)-SMC(f)	PN 1250-0832	1	A
SMB(m)-SMB(m)	PN 1250-0669	1	A	
	BNC(f)-Dual Banana Plug	PN 1251-2277	1	P A

Table 1-1. Required Equipment (sheet 3 of 3)

Equipment	Critical Specifications	Recommended Model	Qty	Use ¹
Service Tool	HP 4195A Adjustment Program	PN 04195-65009	1	A
	Extender Board	PN 04195-66590	1	A
	Template, CRT Alignment	PN 04195-69051	1	A
	Interconnection Cable, 9pin	PN 16349-61601	1	A
	Interconnection Cable, 50pin	PN 16349-61602	1	A
	Interconnection Cable, BNC(m)	PN 16349-61603	3	A
	CRT Section Extension Cable	PN 16349-61604	1	A
Resistor	464Ω, BNC(f)-BNC(f)	Refer to para. 3-7	1	A

Note: ¹ P and A indicate Performance Test and Adjustment, respectively.

² An HP 8496A/G step attenuator with required low VSWR (< 1.02) can be purchased by specifying option H60, then contact your nearest Hewlett-Packard service center for the required calibration frequency and calibration uncertainty.

If your attenuator is an HP 8496G (remote control), also provide the segment actuation sequence for every attenuation as listed below.

Attenuation	Activated Segment
40 dB	4
50 dB	1 and 4
60 dB	2 and 4
70 dB	1,2, and 4

³ An HP 8491A option 006 or option 010 fixed attenuator with required low VSWR (< 1.015) can be purchased by specifying option H60.

1-3. PREPARATION FOR PERFORMANCE TEST/ADJUSTMENT

This paragraph provides the information which you must know, and the steps you must perform, before starting the Performance Test/Adjustment.

1-3-1. SET THE LINE VOLTAGE SELECTION SWITCH

The Line Voltage Selection Switch on the HP 4195A's rear panel must be set to the line voltage in your area, **BEFORE** turning the HP 4195A **ON**.

1-3-2. WARMING UP THE HP 4195A

The HP 4195A must be warmed up for at least 30 minutes, before starting the Performance Test and Adjustment.

1-3-3. EXPRESSION FOR THE KEYS AND SOFTKEYS IN THIS MANUAL

In the remainder of this manual, softkeys are indicated in boldface type and enclosed in single quotes (e.g., '**NETWORK**' softkey), and keys are indicated in boldface type only (e.g., **PRESET** key).

1-3-4. INITIALIZING THE HP 4195A

The performance test and adjustment procedures begin with the HP 4195A in its initialized state. So, after setting the HP 4195A's measurement configuration (**NETWORK**, **SPECTRUM**, **IMPEDANCE**, **S11**, **S12**, **S21**, or **S22**), initialize the HP 4195A by pressing the **PRESET** key (or enter the "**RST**" command from the Keyboard Input Line on the HP 4195A's display).

NOTE

Be sure to first select the **CONFIGURATION**, then press the **PRESET** key. The initialization parameters depend on the measurement configuration selected.

1-3-5. HOW TO SET UP THE HP 4195A

The HP 4195A is set up by pressing the HP 4195A's front panel keys and softkeys. The HP 4195A can also be set up by entering the HP 4195A's Device Dependent Commands which are displayed on the Keyboard Input Line by pressing the alphabetical keys when the BLUE shift key is ON.

In the performance test/adjustment procedures, the COMMANDs (HP 4195A Device Dependent Commands) to set the test condition are listed. If you are familiar with the HP 4195A front panel operation, use the front panel keys to set up the HP 4195A. Otherwise, enter the COMMANDs from the Keyboard Input Line using the BLUE/GREEN shifted alphabetical keys.

How To Enter The COMMAND From The Keyboard Input Line:

1. Press the front panel BLUE shift key, and confirm that the BLUE shift key indicator is ON.
2. If the character for a command is written in green on the front panel, press the GREEN shift key for every green character to be entered.
3. Press the alphabetical keys or the number keys as required.
4. Repeat steps 2 and 3, until the complete command is displayed on the Keyboard Input Line.
5. Press the ENTER/EXECUTE key, to enter the command.

NOTE

When the ENTER/EXECUTE key is pressed, the BLUE shift key indicator will go OFF.

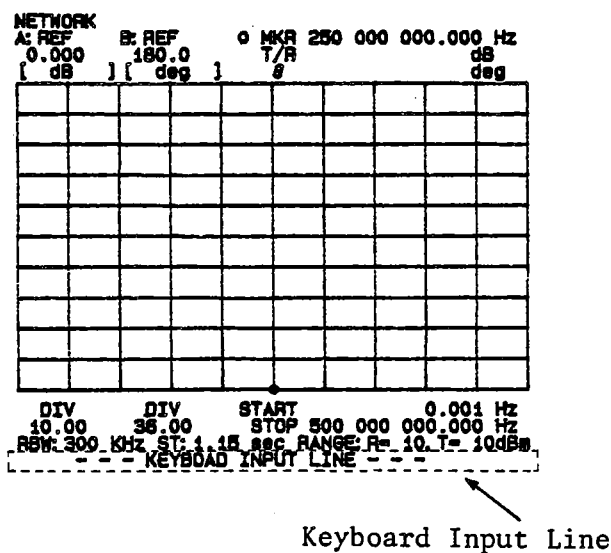

Figure 1-1. Keyboard Input Line Location

1-3-6. USER PROGRAM (AUTO SEQUENCE PROGRAM)

The HP 4195A User Program capability is used to perform some parts of the performance test. This capability can also be used to set up the HP 4195A's test/adjustment condition. The user program can be entered while in the User Program editor by pressing the keys and softkeys that you would press during front panel operation or by entering the **COMMANDS** using the alphabetical keys. The procedure to edit a User Program is shown below.

How to edit a User Program:

1. Press the **PROGRAM** key on the HP 4195A front panel.
2. Press the 'EDIT' softkey and the **ENTER/EXECUTE** key to enter the User Program editor.
3. Press the front panel keys and softkeys, or press the alphabetical keys, to display the commands on the program line. To use multi-statement, use a semicolon (;) as the delimiter to separate commands.
4. Press the **ENTER/EXECUTE** key to enter the command.
5. Repeat steps 3 and 4, until all commands are entered.
6. Press the **PROGRAM** key and 'QUIT editor' softkey to exit from the User Program editor.

When you create an User Program for the periodic test and adjustment, it will be helpful to save the User Program on a flexible disc using the HP 4195A's internal disc drive. Refer to HP 4195A Operation Manual for details of the User Program capability, and for the HP 4195A Device Dependent Commands.

1-3-7. HOW TO READ HP 4195A MEASUREMENT DATA

Some performance test/adjustment procedures use the measured data by the HP 4195A. The HP 4195A displays the measurement data in graphical form as a trace. The HP 4195A displays two traces, the yellow trace is data A, and the blue trace is data B. The measurement data can be read by using a marker to display the measurement data, pointed to by the marker, in the Marker Area, as shown in Figure 1-2.

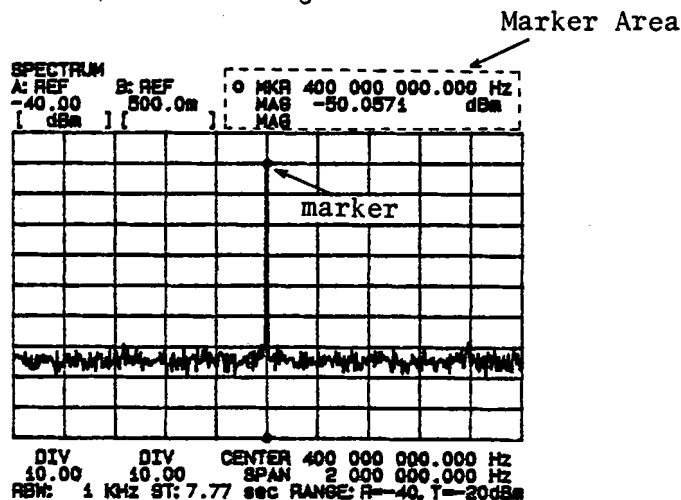

Figure 1-2. Marker Area

1-4. INTERCONNECTION CABLES

The HP 4195A consists of a Control Unit (unit on the top), and a Measurement Unit (unit on the bottom). These units are interconnected as shown in Figure 1-3.

Some of the adjustments require the longer Interconnection Cables. In these adjustments, use the longer Interconnection service Cables, as shown in Figure 1-3, instead of the standard short Interconnection Cables. Unless instructed to use the longer cables, use the furnished standard short Interconnection Cables.

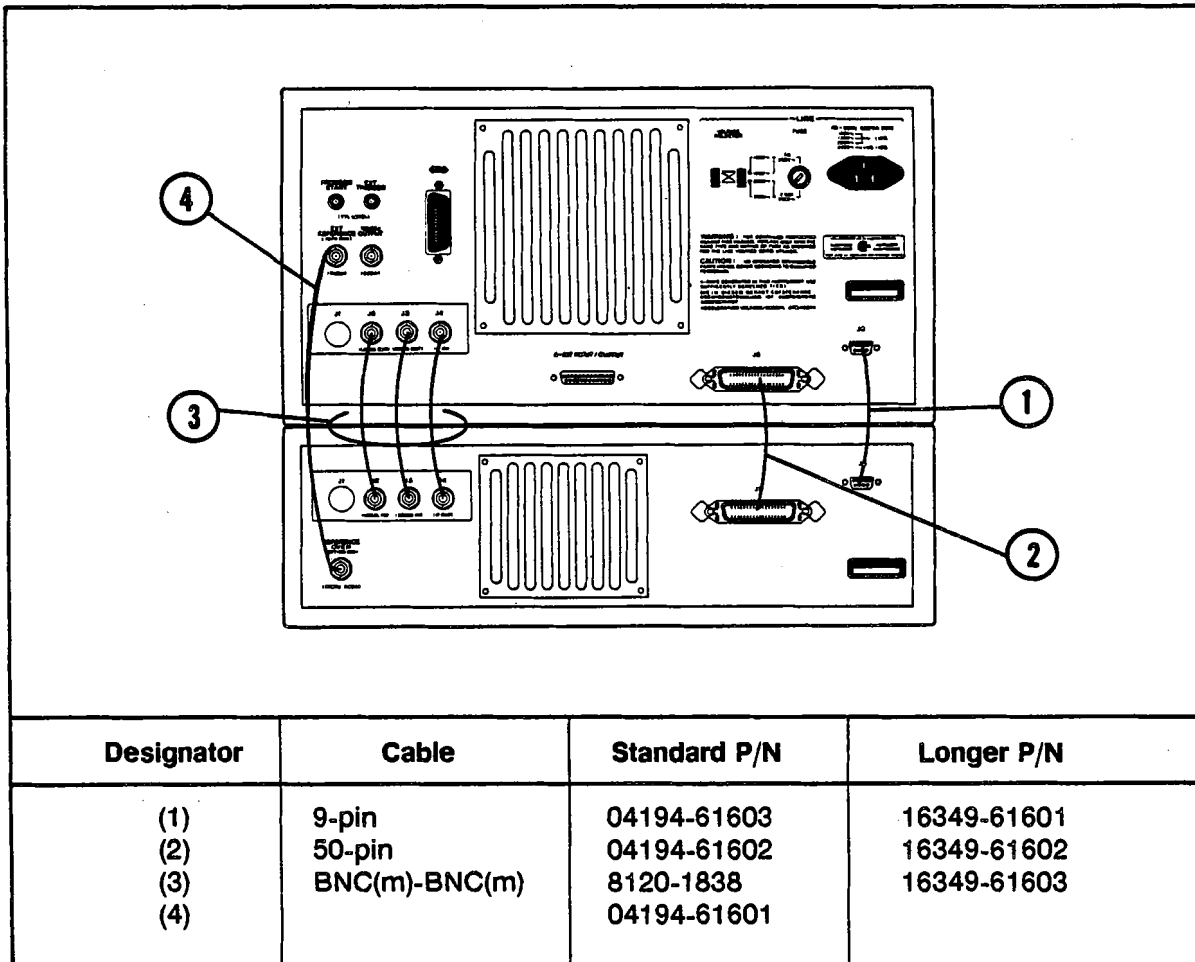

Figure 1-3. Interconnection Cables

SECTION 2

PERFORMANCE TESTS

2-1. INTRODUCTION

This section provides the test procedures used to verify that the HP 4195A's specifications listed in the HP 4195A Operation Manual are met. All tests can be performed without access to the interior of the instrument. The Performance Tests can also be used to perform incoming inspection, and to verify that the HP 4195A meets performance specifications after troubleshooting or adjustment. If the performance tests indicate that the HP 4195A is not operating within the specified limits, check your test setup, and then proceed to Adjustments or Troubleshooting, if necessary.

NOTE

Perform all performance tests in an ambient temperature of $23^{\circ}\text{C}\pm 5^{\circ}\text{C}$.

2-2. PERFORMANCE TEST RECORD

Record the performance test results in the Test Record at the end of this section (Photocopy the Test Record and use the photocopy). The Test record lists all test specifications and their acceptable limits. Test results recorded during incoming inspection can be used for comparison purposes during periodic maintenance, troubleshooting, and after repair or adjustment.

NOTE

The test limits indicated for each test do not take into account the measurement error of the test equipment used. Be sure to take the test equipment's measurement error into account when determining whether or not the HP 4195A meets specifications.

2-3. CALCULATION SHEET

The Calculation Sheet is used to as an aid for recording raw measurement data, and calculating the performance test results.

The performance test procedure gives the test sequence for performing a test, the complete set of measurement data are recorded on the calculation sheet, the results are calculated using the equations given on the calculation sheet, and the results are transcribed to the Performance Test Record.

The Calculation Sheet list the test points, and the test settings.

How to Use the Calculation Sheet:

1. Photo copy the Calculation Sheet.
2. Follow the performance test procedure and record the measurement value, the HP 4195A's reading, etc., into the specified column on the Calculation Sheet.
3. Calculate the test result using the appropriate equation given on the Calculation Sheet.
4. Record the test result into the **TEST RESULT** column on the Calculation Sheet or the Performance Test Record sheet as appropriate.

2-4. CALIBRATION CYCLE

The HP 4195A requires periodic performance verification. The frequency of performance verification depends on the operating and environmental conditions under which the HP 4195A is used. Verify the HP 4195A's performance, using the performance tests described in this section, at least once a year. To minimize instrument down-time and to ensure optimum operation, perform preventive maintenance and calibration at least twice a year.

2-6. INTERNAL SYNTHESIZER FREQUENCY ACCURACY TEST

This test uses an external frequency counter to test the HP4195A's Internal Synthesizer Frequency Accuracy.

SPECIFICATION:

Frequency Accuracy	± 20 ppm ($23 \pm 5^\circ\text{C}$)
	± 1 ppm ($23 \pm 5^\circ\text{C}$; with Option 001)

EQUIPMENT:

Frequency Counter	HP 5385A Opt.004
BNC(m)-BNC(m) Cable, 61 cm	PN 8120-1839
N(m)-BNC(f) Adapter	PN 1250-1476

PROCEDURE:

1. Set up the HP 4195A as follows.

		COMMAND
CONFIGURATION	NETWORK	FNC1
INITIALIZE	PRESET	RST
SPAN	0 Hz	SPAN= 0

2. Connect the BNC(m)-BNC(m) Cable from HP 4195A **OUTPUT S1**, to the Frequency Counter **INPUT B**, as shown in Figure 2-1.

If the HP 4195A is equipped with Option 001, confirm that a BNC(m)-BNC(m) cable is connected between the Control Unit's **EXT REFERENCE** connector and the Measurement Unit's **REFERENCE OVEN** connector. If Option 001 is NOT installed, connect nothing to the **EXT REFERENCE** connector.

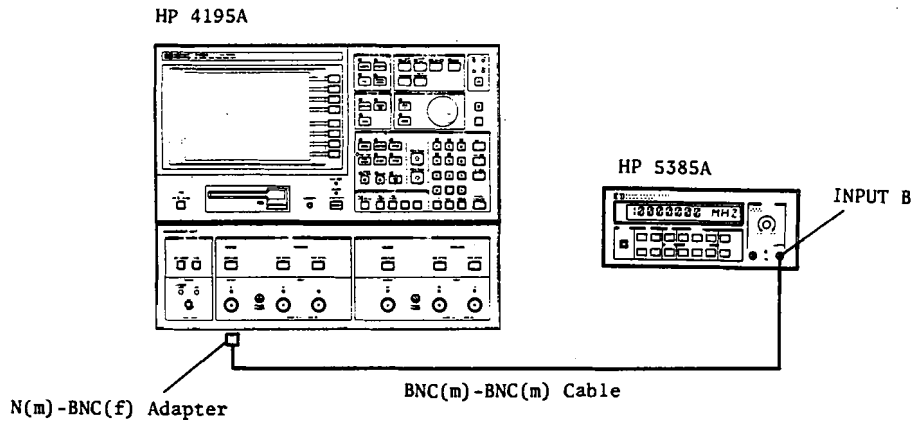

Figure 2-1. Internal Synthesizer Frequency Accuracy Test Setup

PERFORMANCE TESTS

3. Set the HP 4195A **CENTER FREQUENCY** in according to the table below. Record the frequency counter reading on the Performance Test Record.

NOTE

The 100 MHz **CENTER FREQUENCY** can be set by pressing the **CENTER, 1, 0, 0, MHz/V** keys.

HP 4195A CENTER FREQUENCY
100.0 MHz
200.0 MHz
320.1 MHz
500.0 MHz

2-7. RESOLUTION BAND WIDTH ACCURACY TEST

This test measures the HP 4195A's Resolution Bandwidth (RES BW). the internal reference signal (10 MHz) is used as a signal source.

SPECIFICATION:

Resolution Bandwidth Accuracy ±10%

EQUIPMENT:

BNC(m)-BNC(m) Cable, 122 cm	PN 8120-1840
N(m)-BNC(f) Adapter	PN 1250-1476

PROCEDURE:

1. Set up the HP 4195A as follows.

		COMMAND
CONFIGURATION	SPECTRUM	FNC2
INITIALIZE	PRESET	RST
CENTER	10 MHz	CENTER= 10 M
VIDEO FILTER	on	VFTR1
INPUT ATTENUATOR (R1)	40 dB	ATR1= 40
SWEEP TRIGGER MODE	SINGLE	SWM2

NOTE

The INPUT ATTENUATOR can be set by pressing REF ATTN and the up/down keys.

2. Connect the BNC(m)-BNC(m) Cable to the HP 4195A INPUT R1 from its rear panel 10 MHz OUTPUT, as shown in Figure 2-2.

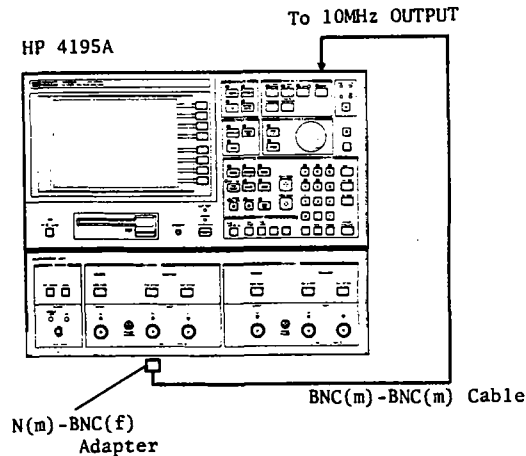

Figure 2-2. RES BW Accuracy Test Set up

PERFORMANCE TESTS

3. Enter the following test program to use the HP 4195A User Program (ASP) capability. The keystrokes are shown in the note below.

10 SPAN= 1.7 * RBW	Set span
20 SWTRG	Make a single sweep measurement
30 AUTO	Perform auto scaling
40 MCF4	Use o marker and Line Cursor
50 MKMX	Move o marker to the max point
60 DLCURS= -3	Move line cursor to -3 dB point
70 WIDTH1	Read -3 dB bandwidth (RES BW)
80 END	

NOTE

Test program can be entered using the following keystrokes. (The ENTER/EXECUTE key is abbreviated as ENTER.)

Begin editing by pressing PROGRAM, 'SCRATCH', ENTER, 'EDIT', ENTER.

LINE	KEYSTROKES
10	SPAN, 1, ., 7, MATH OPERATOR, '*', RES BW, left arrow, DEL CHAR, ENTER
20	TRIG/RESET, ENTER
30	SCALE REF, 'rectan X-A&B', 'AUTO SCALE', ENTER
40	MODE, 'oMKR & LCURS', ENTER
50	MKR→, 'o MKR menu', 'MKR→MAX', ENTER
60	MKR→, 'o-LCURS menu', 'more1/2', 'ΔVALUE entry', -, 3, ENTER
70	'WIDTH on off', 1, ENTER
80	PROGRAM, 'END', ENTER

Press 'QUIT editor' to end editing.

4. Set the HP 4195A RES BW in according to the table below. Run the test program (press PROGRAM, 'RUN'), and wait until sweep ends.
5. Record the displayed WIDTH value on the Performance Test Record. Repeat step 4.

RES BW	
100 Hz	101.2
300 Hz	303.1
1 kHz	1011
3 kHz	3034
10 kHz	9948
30 kHz	31707
100 kHz	105204
300 kHz	299957

2-8. AMPLITUDE MEASUREMENT ACCURACY TEST

This tests the HP 4195A's receiver Amplitude Measurement Accuracy. This test consists of comparing the absolute power level of each input with a power meter or a digital voltmeter.

SPECIFICATION:

Amplitude Measurement Accuracy	±1.0 dB. (at 50 MHz, at the upper limit level of Input Range)
--------------------------------	---

EQUIPMENT:

Power Meter	HP 436A	
Power Sensor	HP 8482A	
Step Attenuator	HP 8496A/G Opt.001	
Signal Generator	HP 8656B	
N(m)-N(m) Cable, 61 cm	HP 11500B	2 ea.
N(f)-N(f) Adapter	PN 1250-1472	
BNC(m)-BNC(m) Cable, 122 cm	PN 8120-1840	

PROCEDURE:

1. Record the Step Attenuator 50 MHz calibration value in the Calculation Sheet column [a].
2. Calibrate the Power Meter for the Power Sensor.
3. Configure the test setup shown in Figure 2-3. The N(m)-N(m) cable must be connected between the Step Attenuator and the Power Sensor with the N(f)-N(f) Adapter.

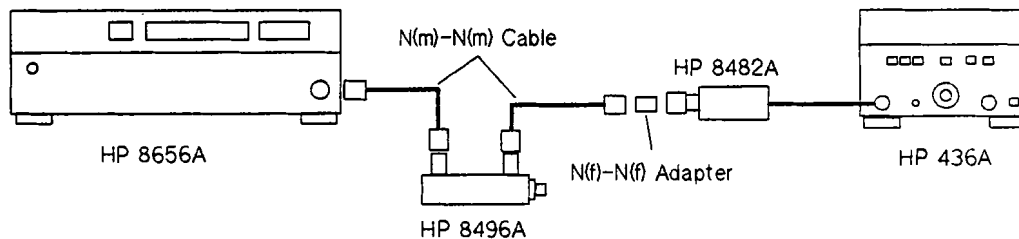

Figure 2-3. Amplitude Measurement Accuracy Test Setup

PERFORMANCE TESTS

4. Set the Signal Generator **AMPLITUDE** and **FREQUENCY**, and the Step Attenuator as follows.

Signal Generator Output Amplitude	10 dBm
Signal Generator Output Frequency	50 MHz
Step Attenuator	0 dB

5. Record the Power Meter reading in the Calculation Sheet column [b].

NOTE

The power meter reading should be +10 dBm \pm 2 dB.

6. Set up the HP 4195A as follows.

COMMAND

CONFIGURATION	SPECTRUM	COMMAND
INITIALIZE	PRESET	RST
SWEEP TRIGGER MODE	MANUAL	SWM3
CENTER	50 MHz	CENTER= 50 M
SPAN	0 Hz	SPAN= 0
RES BW	10 Hz	RBW= 10
VIDEO FILTER	on	VFTR1

7. Disconnect the N(m)-N(m) cable from the Power Sensor, and connect it to HP 4195A **INPUT R1** as shown in Figure 2-4. Connect the BNC(m)-BNC(m) Cable between the Signal Generator's **TIME BASE OUTPUT** connector and the HP 4195A's **EXT REFERENCE** connector.

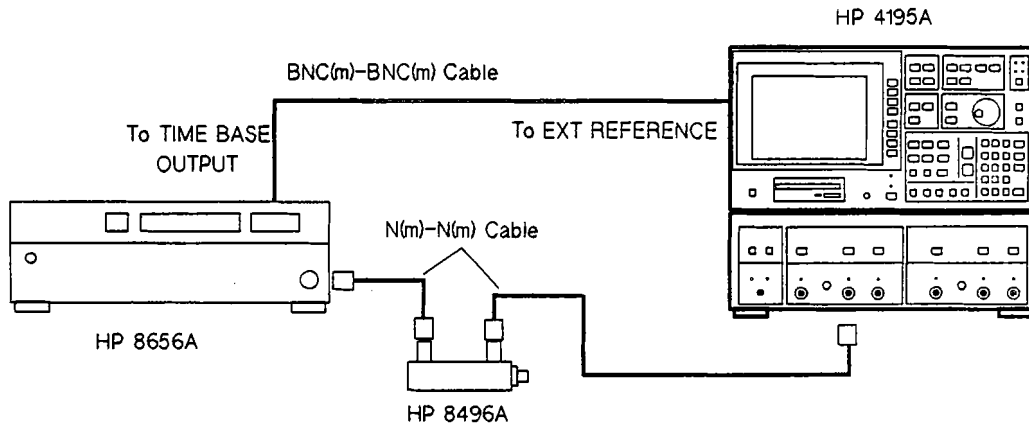

Figure 2-4. Amplitude Measurement Accuracy Test Setup

PERFORMANCE TESTS

8. Set the **Step Attenuator**, the **HP 4195A IF RANGE**, and the **INPUT ATTENUATOR** as follows, and then record the HP 4195A data A value (**MAG**) into Calculation Sheet column [c].

Step Attenuator	HP 4195A INPUT ATTENUATOR	HP 4195A IF RANGE
20 dB 30 dB	10 dB 10 dB	NORMAL LOW DISTORTION

NOTE

The **IF RANGE** can be selected by selecting and pressing a softkey that appears after **REF ATTN** is pressed.

9. Set the **HP 4195A IF RANGE** to the **HIGH SENSITIVITY** mode.
10. Set the **Step Attenuator** and the **HP 4195A INPUT ATTENUATOR** as follows, and record the HP 4195A data A value (**MAG**) into Calculation Sheet column [c].

Step Attenuator	HP 4195A INPUT ATTENUATOR
50 dB	0 dB
40 dB	10 dB
30 dB	20 dB
20 dB	30 dB
10 dB	40 dB
0 dB	50 dB

11. Change the **Attenuator Connection** and the **HP 4195A INPUT PORT** in according to the table below, and repeat step 10.

Attenuator Connection	HP 4195A INPUT PORT
T1	T1 ("PORT2")
R2	R2 ("PORT3")
T2	T2 ("PORT4")

NOTE

To set the **INPUT ATTENUATOR** for **INPUT PORTs T1, R2, and T2**, press the proper **REF ATTN** or **TEST ATTN** key then press the up/down arrow keys until the desired attenuation is displayed.

12. Use the equation given on the Calculation Sheet to calculate the test results (absolute accuracy), and transcribe the test results to the Performance Test Record.

2-9. AMPLITUDE MEASUREMENT LINEARITY TEST

This tests the HP 4195A's receiver Amplitude Measurement Linearity. The linearity is determined by measuring several input signal levels. The internal signal source and a step attenuator are used to apply these test signals.

SPECIFICATION:

- Linearity (at $23 \pm 5^\circ\text{C}$):

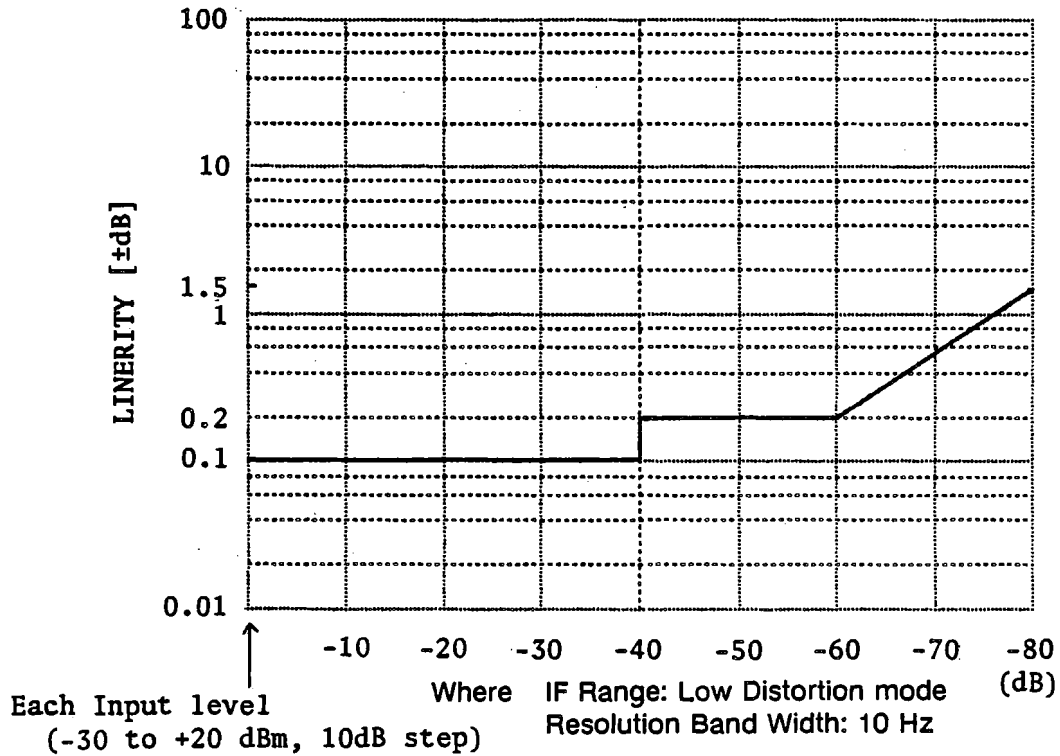

EQUIPMENT:

Step Attenuator
N(m)-N(m) Cable, 61 cm

HP 8496A/G Opt.001
HP 11500B 2 ea.

PROCEDURE:

1. Record the Step Attenuator 50 MHz calibration value into the Calculation Sheet column [b].

PERFORMANCE TESTS

2. Set up the HP 4195A as follows.

		COMMAND
CONFIGURATION	SPECTRUM	FNC2
INITIALIZE	PRESET	RST
SWEEP TRIGGER MODE	MANUAL	SWM3
CENTER	49.999 MHz	CENTER= 49.999 M
SPAN	0 Hz	SPAN= 0
RES BW	10 Hz	RBW= 10
PORT SELECT	SOURCE CH1	PWR1
SOURCE AMPLITUDE (S1)	-30 dBm	OSC1= -30
INPUT ATTENUATOR (R1)	0 dB	ATR1= 0
IF RANGE	LOW DISTORTION	IRNG2

NOTE

SOURCE S1 can be set by pressing **CONFIG**, **'PORT SELECT'**, and **'SOURCE CH1'**.

3. Connect the Step Attenuator to the HP 4195A as shown in Figure 2-5, and set the Step Attenuator to 0 dB.

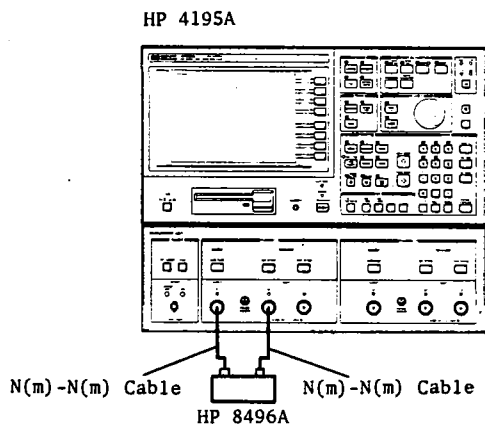

Figure 2-5. Amplitude Measurement Linearity Test Setup

4. Vary the HP 4195A **SOURCE AMPLITUDE (S1)** with up/down arrow keys, so that HP 4195A data A (**MAG**) value is as close as possible to -30 dBm, and then record the data A (**MAG**) value into the Calculation Sheet column [c].
5. Increment the Step Attenuator setting from 10 dB to 80 dB in 10 dB steps, and record the HP 4195A data A (**MAG**) value at each step into the Calculation Sheet column [c].
6. Use the equation given on the Calculation Sheet to calculate the test results, and transcribe the test results to the Performance Test Record.

2-10. AMPLITUDE MEASUREMENT FREQUENCY RESPONSE TEST

This tests the HP 4195A's receiver **Amplitude Measurement Frequency Response**. This test consists of comparing the absolute power level of each input with a digital voltmeter or a power meter reading at several frequencies. The signal is applied from the internal signal source.

SPECIFICATION:

Amplitude Measurement Frequency Response
 ± 1.5 dB (when attenuator = 10 dB)

EQUIPMENT:

Digital Voltmeter	HP 3456A
Power Meter	HP 436A
Power Sensor	HP 8482A
Power Splitter	HP 11667A
50 Ω Feedthrough	PN 04192-61002
N(m)-N(m) Cable, 61cm	HP 11500B
BNC(m)-BNC(m) Cable, 61cm	PN 8120-1839
N(m)-N(m) Adapter	PN 1250-1475
N(m)-BNC(f) Adapter	PN 1250-1476
BNC(f)-Dual Banana Plug Adapter	PN 1251-2277

PROCEDURE:

1. Set up the HP 4195A as follows.

		COMMAND
CONFIGURATION	SPECTRUM	FNC2
INITIALIZE	PRESET	RST
SWEEP TRIGGER MODE	MANUAL	SWM3
SPAN	0 Hz	SPAN= 0
RES BW	10 Hz	RBW= 10
PORT SELECT	SOURCE CH1	PWR1
SOURCE AMPLITUDE (S1)	-14 dBm	OSC1= -14
INPUT ATTENUATOR (ALL)	10 dB	ATR1= 10
		ATT1= 10
		ATR2= 10
		ATT2= 10
IF RANGE	LOW DISTORTION	IRNG2
VIDEO FILTER	on	VFTR1

PERFORMANCE TESTS

2. Configure the test equipment as shown in Figure 2-6. Use the N(m)-N(m) Adapter to connect the Power Splitter to HP 4195A INPUT R1. Connect the 50 Ω feedthrough at the Digital Voltmeter INPUT. Connect the Voltmeter input cable to the Power Splitter.

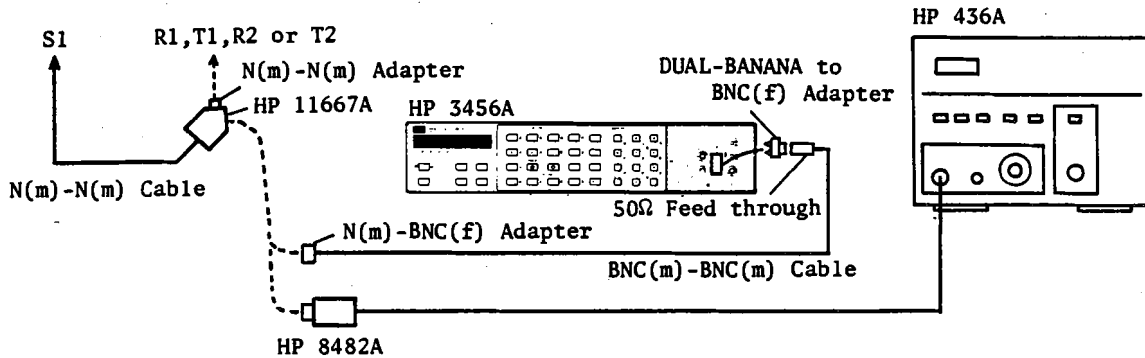

Figure 2-6. Amplitude Measurement Frequency Response Test Setup

3. Set the the Digital Voltmeter to read AC Volts and press the **MATH, 4, 5, 0, STORE,** and **4** keys, in sequence, to convert and display the voltage readings in **dBm** units.
4. Set the HP 4195A **CENTER FREQUENCY** to 10 Hz, and record the HP 4195A data A (**MAG**) value and the reading of the Digital Voltmeter into the Calculation Sheet columns [a] and [b], respectively.
5. Set the HP 4195A **CENTER FREQUENCY** to 100 kHz, and record the reading of the Digital Voltmeter in Calculation Sheet column [c].
6. Connect the Power Sensor to the Power Meter, and calibrate the Power Meter to the Power Sensor.
7. Disconnect the Digital Voltmeter input cable from the Power Splitter, and connect the Power Sensor to the Power Splitter.

PERFORMANCE TESTS

8. Set the HP 4195A **CENTER FREQUENCY** to the following values, and record HP 4195A data A (**MAG**) value, and the Power Meter reading into the Calculation Sheet columns [a] and [b], respectively.

NOTE

Before recording the value, confirm that both the HP 4195A's data A and the Power Meter reading are within $-20 \text{ dBm} \pm 4 \text{ dB}$.

CENTER FREQUENCY
100 kHz
50 MHz
9.99 MHz (R1 only)
10 MHz
149.99 MHz (R1 only)
150 MHz

CENTER FREQUENCY
224.99 MHz (R1 only)
225 MHz
339.99 MHz (R1 only)
340 MHz
500 MHz

9. Disconnect the Power Splitter with the N(m)-N(m) Adapter from the HP 4195A **INPUT**.
10. Disconnect the Power Sensor from the Power Splitter, and connect the Digital Voltmeter input cable to the Power Splitter.
11. Set the HP 4195A **INPUT PORTS** as follows, and connect the Power Splitter using the N(m)-N(m) Adapter to HP 4195A **INPUTS** T1, R2, and T2, and repeat steps 3 through 10 for each setting.

INPUT PORT	COMMAND
T1	PORT2
R2	PORT3
T2	PORT4

NOTE

When performing step 8, skip **CENTER FREQUENCY(s)** labeled "R1 only".

12. Use the equation given on the Calculation Sheet to calculate the test results, and transcribe the test results to the Performance Test Record.

2-11. SECOND HARMONIC DISTORTION TEST

This test measures the HP 4195A receiver's **Second Harmonic Distortion**. This test measures the second harmonic (double frequency) level of input signal. A low-pass filter is inserted between the external signal generator and the input in order to eliminate the Signal Generator's own second harmonic from adding error directly.

SPECIFICATION:

Second Harmonic Distortion	≤ -70 dBc referenced to the sinusoidal signals (≥ 2 MHz) which is equal to every Input Ranges (IF Range: Low Distortion mode)
----------------------------	--

EQUIPMENT:

Signal Generator	HP 8656B	
50 MHz Low Pass Filter	PN 0955-0306	
N(m)-N(m) Cable, 61 cm	HP 11500B	2 ea.
BNC(m)-BNC(m) Cable, 122 cm	PN 8120-1840	
N(f)-BNC(m) Adapter	PN 1250-1477	
N(f)-BNC(f) Adapter	PN 1250-1474	

PROCEDURE:

1. Set up the HP 4195A as follows.

CONFIGURATION	SPECTRUM	COMMAND
INITIALIZE	PRESET	FNC2
SWEEP TRIGGER MODE	SINGLE	RST
CENTER	50 MHz	SWM2
SPAN	50 kHz	CENTER= 50 M
RES BW	1 kHz	SPAN= 50 K
INPUT ATTENUATOR (R1)	30 dB	RBW= 1 K
IF RANGE	LOW DISTORTION	ATR1= 30
		IRNG2

PERFORMANCE TESTS

- Set up the test configuration shown in Figure 2-7. Connect the BNC(m)-BNC(m) cable between the Signal Generator's **TIME BASE OUTPUT** connector and the HP 4195A's **EXT REFERENCE** connector.

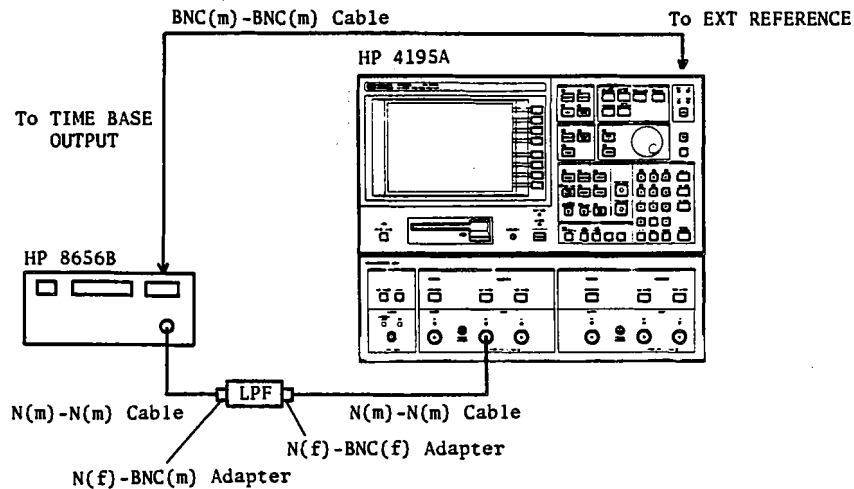

Figure 2-7. Second Harmonic Distortion Test Setup

- Set the Signal Generator **FREQUENCY** to 50 MHz, and **AMPLITUDE** to 0 dBm.
- Press the **TRIG/RESET** key, and wait until the single sweep measurement is completed.
- Press the **MKR→**, '**MKR→MAX**' keys to move the o marker to the peak point. Record the HP 4195A data A (**MAG**) value into the Calculation Sheet column [a], (this is the reference value).
- Change the HP 4195A **CENTER FREQUENCY** to 100 MHz, and press the **TRIG/RESET** key.
- Move the o marker to the peak point, and record the HP 4195A data A (**MAG**) value into the Calculation Sheet column [b].
- Use the equation given on the Calculation Sheet to calculate the test result, and transcribe the test results to the Performance Test Record.

2-12. THIRD ORDER INTERMODULATION DISTORTION TEST

This test measures the HP 4195A's receiver Third Order Intermodulation Distortion. A directional bridge is used to combine the two signals applied by two signal generators, and the frequency of these signals is separated by 0.5 MHz from each other. This performance is determined by measuring the amplitude of intermodulation frequency.

SPECIFICATION:

Third Order Intermodulation Distortion

≤ -80 dBc referenced to two sinusoidal signals (≥ 2 MHz; 500 kHz separation) which are lower 6 dB than every Input Ranges. (IF Range: Low Distortion mode)

EQUIPMENT:

Signal Generator	HP 8656B	2 ea.
BNC(m)-BNC(m) Cable, 122 cm	PN 8120-1840	2 ea.
N(m)-N(m) Cable, 61 cm	HP 11500B	3 ea.
Signal Combiner	PN 41952-65001 (included in HP 41952A)	
50 Ω Termination	HP 909C Opt. 012	
N(f)-N(f) Adapter	HP PN 1250-0777	2 ea.

PROCEDURE:

1. Set up the HP 4195A as follows.

		COMMAND
CONFIGURATION	SPECTRUM	FNC2
INITIALIZE	PRESET	RST
SWEEP TRIGGER MODE	MANUAL	SWM3
SPAN	0 Hz	SPAN= 0
RES BW	10 Hz	RBW= 10
INPUT ATTENUATOR	0 dB	ATR1= 0
IF RANGE	LOW DISTORTION	IRNG2

PERFORMANCE TESTS

- Set up the test configuration as shown in Figure 2-8. Connect the BNC(m)-BNC(m) cable between the Signal Generator's **TIME BASE OUTPUT** connector and the HP 4195A's **EXT REFERENCE** connector.

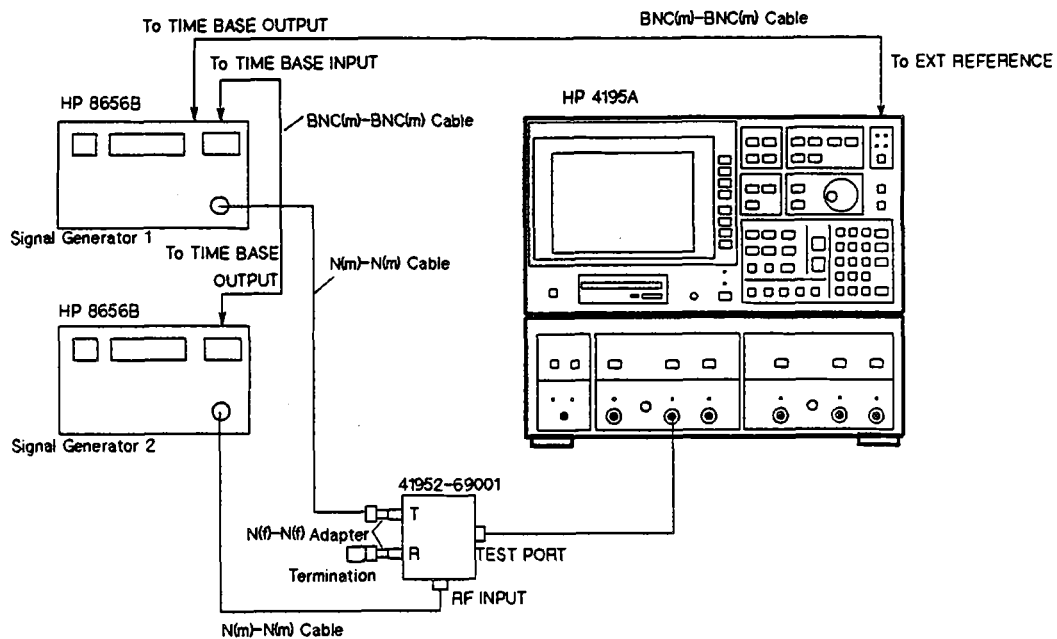

Figure 2-8. Third Order Intermodulation Distortion Test Setup

- Set the **OUTPUT AMPLITUDE** of Signal Generators 1 and 2, to **-23 dBm** and **-30 dBm**, respectively.

PERFORMANCE TESTS

4. Set the **OUTPUT FREQUENCY** of Signal Generators 1 and 2 as follows, and repeat steps A through E for each set of values.

Signal Generator 1 Output Frequency	Signal Generator 2 Output Frequency	Intermodulation Frequency	
		[F-0.5 MHz]	[F+1.0 MHz]
[F MHz]	[F + 0.5 MHz]		
2.02 MHz	2.52 MHz	1.52 MHz	3.02 MHz
5.02 MHz	5.52 MHz	4.52 MHz	6.02 MHz
10.20 MHz	10.70 MHz	9.70 MHz	11.20 MHz
20.20 MHz	20.70 MHz	19.70 MHz	21.20 MHz
50.20 MHz	50.70 MHz	49.70 MHz	51.20 MHz
100.20 MHz	100.70 MHz	99.70 MHz	101.20 MHz
200.20 MHz	200.70 MHz	199.70 MHz	201.20 MHz
499.20 MHz	499.70 MHz	498.70 MHz	---

- A. Set the HP 4195A **CENTER FREQUENCY** to [F+0.5 MHz], and vary Signal Generator 2's output amplitude until the HP 4195A data A (**MAG**) value is as close as possible to -36 dBm.
- B. Set the HP 4195A **CENTER FREQUENCY** to F MHz, and vary Signal Generator 1 output amplitude until the HP 4195A data A (**MAG**) value is as close as possible to -36 dBm.
- C. Record the HP 4195A data A (**MAG**) value as the value of a in column [b] on the Calculation sheet.
- D. Set the HP 4195A **CENTER FREQUENCY** to the lower intermodulation frequency [F-0.5 MHz], and record the HP 4195A data A (**MAG**) in Calculation Sheet column [b].
- E. Set the HP 4195A **CENTER FREQUENCY** to the upper intermodulation frequency [F+1.0 MHz], and record the HP 4195A data A (**MAG**) value as the value of b in Calculation Sheet column [b].
5. Use the equation given on the Calculation Sheet to calculate the test results, and record the test results in the Performance Test Record.

2-13. RESIDUAL RESPONSE TEST

This tests the HP 4195A's **Residual Response**. This test measures how effectively the HP 4195A's internal oscillator signal's interference is reduced by measuring the amplitude at some known frequencies with its input terminated.

SPECIFICATION:

Residual Response -110 dBm at ≥ 100 kHz, Attenuator=0 dB (IF Range: High Sensitivity mode)

EQUIPMENT:

50 Ω Termination

HP 909C Opt.012

PROCEDURE:

1. Set up the HP 4195A as follows.

CONFIGURATION	SPECTRUM	COMMAND
INITIALIZE	PRESET	FNC2
SWEEP TRIGGER MODE	SINGLE	RST
INPUT ATTENUATOR (R1)	0 dB	SWM2
IF RANGE	HIGH SENSITIVITY	ATR1= 0
CENTER	2 MHz	IRNG3
SPAN	20 kHz	CENTER= 2 M
RES BW	100 Hz	SPAN= 20 K
		RBW= 100

2. Connect the 50 Ω Termination to HP 4195A **INPUT R1**, as shown in Figure 2-9.

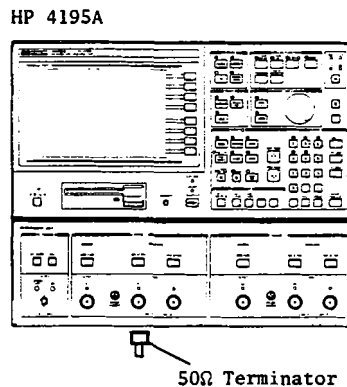

Figure 2-9. Residual Response Test Setup

PERFORMANCE TESTS

3. Press the HP 4195A TRIG/RESET key, and wait until the single sweep measurement is completed.
4. Press MKR→, 'MKR→MAX' to move the o marker to the maximum point of the displayed data, and record the data A (MAG) value and the frequency at which the maximum point occurred into the Performance Test Record.
5. Repeat steps 3 and 4, for the following HP 4195A CENTER FREQUENCY settings.

CENTER FREQUENCY
27.407 407 MHz
105.714 285 MHz
133.333 333 MHz
150.000 000 MHz
160.000 000 MHz
235.555 555 MHz
320.000 000 MHz
333.333 333 MHz
360.000 000 MHz
375.555 555 MHz
404.444 444 MHz
480.000 000 MHz

PERFORMANCE TESTS

2-14. LEVEL ACCURACY/FLATNESS TEST

This test measures the HP 4195A's signal source output **Level Accuracy/Flatness**. A digital voltmeter or a power meter is used to measure each output port level at several frequencies.

SPECIFICATIONS:

Level Accuracy	± 0.5 dB at +10 dBm, 50 MHz
Level Flatness	± 1.5 dB

EQUIPMENT:

Digital Voltmeter	HP 3456A
Power Meter	HP 436A
Power Sensor	HP 8482A
50 Ω Feedthrough	PN 04192-61002
BNC(m)-BNC(m) Cable, 61 cm	PN 8120-1839
N(m)-BNC(f) Adapter	PN 1250-1476
BNC(f)-Dual Banana Plug Adapter	PN 1251-2277

PROCEDURE:

1. Set up the HP 4195A as follows.

		COMMAND
CONFIGURATION	NETWORK	FNC1
INITIALIZE	PRESET	RST
SPAN	0 Hz	SPAN= 0
SOURCE AMPLITUDE (S1)	10 dBm	OSC1= 10

2. Connect the Digital Voltmeter **INPUT** to HP 4195A **OUTPUT S1**, as shown in Figure 2-10 (use a 50 Ω Feedthrough on the Digital Voltmeter input).

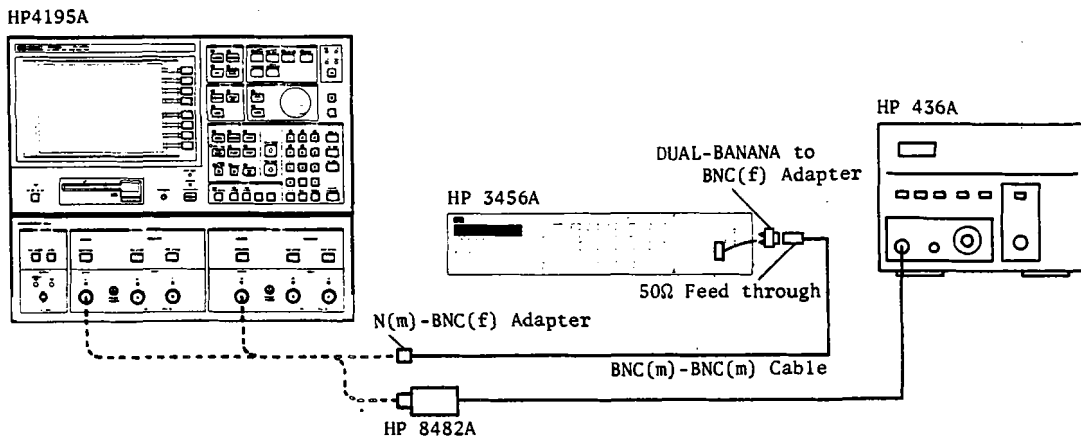

Figure 2-10. Level Accuracy/Flatness Test Setup

PERFORMANCE TESTS

3. Set the Digital Voltmeter to read AC Volts and press the **MATH, 4, 5, 0, STORE,** and **4** keys, in sequence, to convert and display the voltage readings in **dBm**.
4. Set the HP 4195A **CENTER FREQUENCY** as follows, and record the Digital Voltmeter reading in the Calculation Sheet column [a] for each setting.

HP 4195A CENTER FREQUENCY
10 Hz
100 Hz
1 kHz

HP 4195A CENTER FREQUENCY
10 kHz
100 kHz

5. Connect the Power Sensor to the Power Meter, and calibrate the Power Meter for the Power Sensor.
6. Disconnect the Digital Voltmeter from the HP 4195A **OUTPUT**, and connect the Power Sensor to the HP 4195A **OUTPUT**.
7. Set the HP 4195A **CENTER FREQUENCY** as follows, and record the Power Meter reading into Calculation Sheet column [a].

HP 4195A CENTER FREQUENCY
100 kHz
50 MHz
1 MHz
9.99 MHz
10 MHz
149.9 MHz
150 MHz
192 MHz

HP 4195A CENTER FREQUENCY
224.9 MHz
225 MHz
300 MHz
339.9 MHz
340 MHz
420 MHz
500 MHz

8. Transcribe the value of [d] on the Calculation Sheet to the **LEVEL ACCURACY** column in the Performance Test Record.
9. Use the equation given on the Calculation sheet to calculate the test results (Flatness), and transcribe the test results to the **FLATNESS** column in the Performance Test Record.
10. Disconnect the Power Sensor from **OUTPUT S1**, and connect the Digital Voltmeter to the HP 4195A **OUTPUT S2**.
11. Change the following HP 4195A settings, and repeat steps 4 through 9.

	COMMAND	
INPUT PORT	T2/R2	PORT5
SOURCE AMPLITUDE (S2)	10 dBm	OSC2= 10

2-15. NON-SWEEP LINEARITY TEST

This tests the HP 4195A's signal source **Output Linearity (non power sweep)**. The linearity is measured by HP 4195A's receiver.

NOTE

Since this test depends on the HP 4195A's receiver linearity, confirm that this linearity is within specification using the "2-9. **AMPLITUDE MEASUREMENT LINEARITY TEST**".

SPECIFICATION:

Output Level Linearity ± 0.5 dB (at -35 dBm to +10 dBm)

EQUIPMENT:

N(m)-N(m) Cable, 61 cm HP 11500B 1 ea.

PROCEDURE:

1. Set up the HP 4195A as follows.

		COMMAND
CONFIGURATION	SPECTRUM	FNC2
INITIALIZE	PRESET	RST
PORT SELECT	SOURCE CH1	PWR1
SWEEP TRIGGER MODE	MANUAL	SWM3
CENTER	49.999 MHz	CENTER=49.999 M
SPAN	0 Hz	SPAN= 0
RES BW	10 Hz	RBW= 10
SOURCE AMPLITUDE (S1)	+10 dBm	OSC1= 10
INPUT ATTENUATOR (R1)	40 dB	ATR1= 40
IF RANGE	LOW DISTORTION	IRNG2

2. Connect the N(m)-N(m) Cable between HP 4195A's **OUTPUT S1** and **INPUT R1** as shown in Figure 2-11.

NOTE

Confirm the INPUT R1 level (**MAG**) is within 10dBm \pm 1.5 dB.

PERFORMANCE TESTS

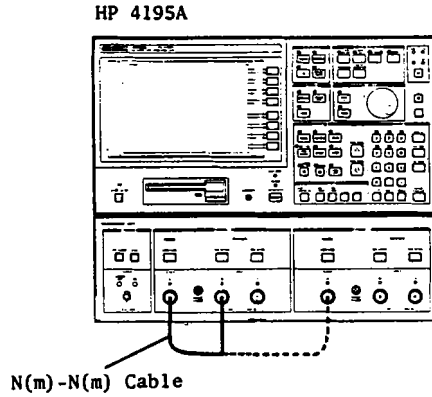

Figure 2-11. Non-sweep Linearity Test Setup

3. Set the HP 4195A SOURCE AMPLITUDE and INPUT ATTENUATOR as follows, and record the HP 4195A data A (MAG) value into Calculation Sheet column [b].

SOURCE AMPLITUDE	INPUT ATTENUATOR
10 dBm	40 dB
5 dBm	40 dB
0 dBm	40 dB
0 dBm	30 dB
-5 dBm	30 dB
-10 dBm	30 dB
-15 dBm	30 dB
-20 dBm	30 dB
-25 dBm	30 dB
-30 dBm	30 dB
-35 dBm	30 dB

4. Press **CONFIG**, **'PORT SELECT'**, and **'SOURCE CH2'** to change the HP 4195A SOURCE PORT to CH2.
5. Connect the N(m)-N(m) Cable between HP 4195A **OUTPUT S2** and **INPUT R1**. Set INPUT ATTENUATOR to 40 dB. Then set S2 SOURCE AMPLITUDE to 10 dBm and repeat step 3.
6. Use the equation given on the Calculation Sheet to calculate the test results, and transcribe the test results to the Performance Test Record.

2-16. POWER SWEEP LINEARITY TEST

This tests the HP 4195A's signal source **Output Linearity (power sweep)**. The linearity is measured by its receiver with an external step attenuator that allows the receiver input level to be nearly the same while the source output amplitude is varied.

SPECIFICATION:

Power Sweep Linearity ± 0.2 dB/10 dB.

EQUIPMENT:

N(m)-N(m) Cable, 61 cm	HP 11500B	2 ea.
Step Attenuator	HP 8496A, Opt.001	

PROCEDURE:

1. Record the Step Attenuator Calibration Value at 50 MHz into column **a1** and **a2** on the Calculation Sheet.

2. Set up the HP 4195A as follows.

COMMAND

CONFIGURATION	SPECTRUM	FNC2
INITIALIZE	PRESET	RST
PORT SELECT	SOURCE CH1	PWR1
SWEEP PARAMETER	OSC LVL (dBm)	SWP4
SPOT FREQUENCY	50 MHz	FREQ= 50 M
SWEEP RESOLUTION	No. of POINTS = 14	NOP= 14
SWEEP TRIGGER MODE	MANUAL	SWM3
RES BW	10 Hz	RBW= 10
INPUT ATTENUATOR (R1)	20 dB	ATR1= 20

NOTE

To set the NUMBER OF POINTS to 14, enter the command shown above or press MENU, 'RESOLUTN menu', 'No. of POINTS', 1, 4, and ENTER/EXECUTE.

PERFORMANCE TESTS

- Configure the test equipment as shown in Figure 2-12.

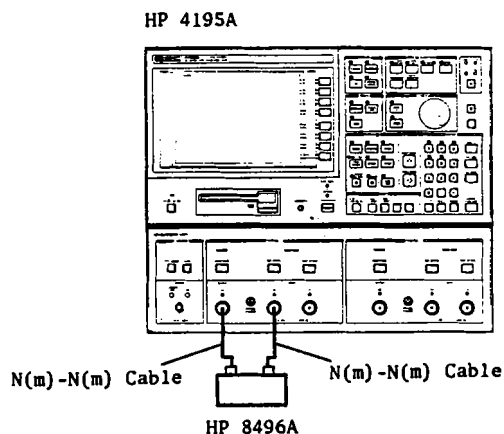

Figure 2-12. Power Sweep Linearity Test Setup

- Set the HP 4195A and the Step Attenuator as follows, and move the o (manual) marker to the point indicated by Test Point listed below, and record the HP 4195A data A (**MAG**) value in the Calculation Sheet column [b].

NOTE

Confirm the data A (**MAG**) value is nearly equal to the theoretical **INPUT LEVEL** value shown on the Calculation Sheet.

INPUT Attenuator	Step Attenuator	START Level	STOP Level	No. of POINTS	Test Point (OUTPUT LEVEL)
<i>ATRI</i> =	/	<i>START</i> =	<i>STOP</i> =	<i>NOP</i> =	<i>MANUAL</i> =
20 dB	10 dB 20 dB	-16 dBm	10 dBm	14	0 dBm 10 dBm
10 dB	10 dB 20 dB	-21 dBm	5 dBm	14	-5 dBm 5 dBm
0 dB	10 dB 0 dB 20 dB				-11 dBm -21 dBm -1 dBm

- Calculate the test results with the equation given on the Calculation Sheet, and transcribe the test results to the Performance Test Record.

2-17. SECOND HARMONICS TEST

This test measures the HP 4195A's signal source **Output Purity** with a spectrum analyzer.

SPECIFICATION:

Internal Signal Source Harmonic Distortion
 < -30 dBc (at 10 dBm)

EQUIPMENT:

Spectrum Analyzer	HP 8568B
N(m)-N(m) Cable, 61 cm	HP 11500B
BNC(m)-BNC(m) Cable, 122 cm	PN 8120-1840

PROCEDURE:

1. Set up the HP 4195A as follows.

		COMMAND
CONFIGURATION	NETWORK	FNC1
INITIALIZE	PRESET	RST
SOURCE AMPLITUDE (S1)	10 dBm	OSC1= 10
SPAN	0 Hz	SPAN= 0

2. Connect the N(m)-N(m) Cable between HP 4195A **OUTPUT S1** and the Spectrum Analyzer **SIGNAL INPUT 2**, and connect a BNC(m)-BNC(m) cable between HP 4195A's **EXT REFERENCE** connector and the spectrum analyzer's **FREQUENCY REFERENCE OUTPUT** connector as shown in Figure 2-13.

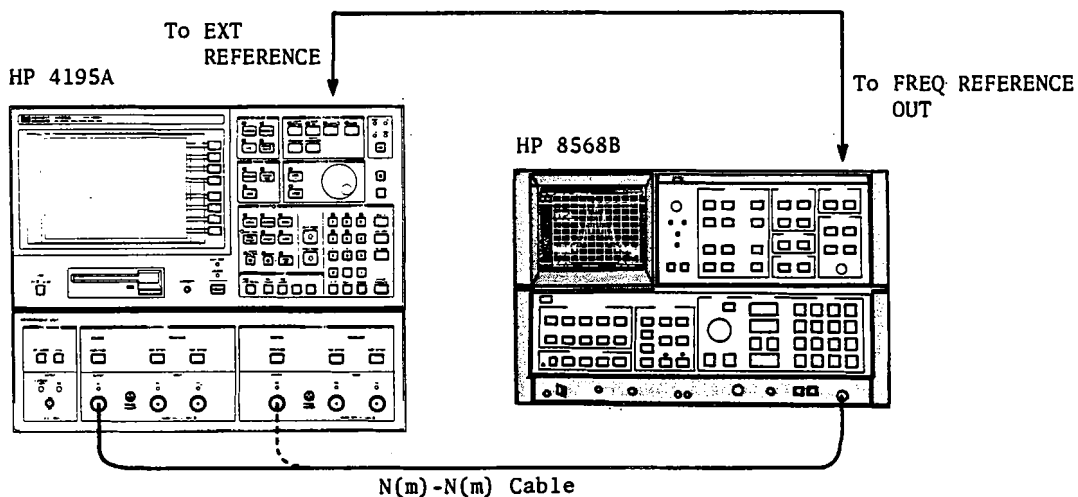

Figure 2-13. Second Harmonics Test Setup

PERFORMANCE TESTS

3. Set the Spectrum Analyzer as follows.

FREQUENCY SPAN	1 MHz
REFERENCE LEVEL	+20 dBm

4. Set the HP 4195A **CENTER FREQUENCY**, and Spectrum Analyzer **CENTER FREQUENCY**, as follows, and record the Spectrum Analyzer reading for each Center Frequency setting in the Calculation Sheet.

NOTE

Confirm that the spectrum analyzer reading at the HP 4195A's center frequency is within 10 dBm \pm 3 dB.

HP 4195A CENTER FREQUENCY	Spectrum Analyzer Center Frequency
5 MHz	5 MHz 10 MHz
150 MHz	150 MHz 300 MHz
225 MHz	225 MHz 450 MHz
340 MHz	340 MHz 680 MHz

5. Disconnect the N(m)-N(m) Cable from HP 4195A **OUTPUT S1**, and connect it to **OUTPUT S2**.
6. Change the HP 4195A settings as follows, and repeat step 3.

	COMMAND	
INPUT PORT	T2/R2	PORT5
SOURCE AMPLITUDE (S2)	10 dBm	OSC2= 10

7. Use the equation given on the Calculation Sheet to calculate the test results, and transcribe the test results to the Performance Test Record.

2-18. NON-HARMONIC SPURIOUS TEST

This test uses a spectrum analyzer to measure the HP 4195A's signal source **Non-Harmonic Spurious** signal which appear near the carrier frequency.

SPECIFICATION:

Non Harmonic Spurious < -50dBc (at 10 dBm)

EQUIPMENT:

Spectrum Analyzer	HP 8568B
N(m)-N(m) Cable, 61 cm	HP 11500B
BNC(m)-BNC(m) Cable, 122 cm	PN 8120-1840

PROCEDURE:

1. Set up the HP 4195A as follows.

		COMMAND
CONFIGURATION	NETWORK	FNC1
INITIALIZE	PRESET	RST
SOURCE AMPLITUDE (S1)	10 dBm	OSC1= 10
SPAN	0 Hz	SPAN= 0

2. Connect an N(m)-N(m) Cable between HP 4195A **OUTPUT S1** and the Spectrum Analyzer **SIGNAL INPUT 2**, and connect the BNC(m)-BNC(m) cable between HP 4195A's **EXT REFERENCE** connector and spectrum analyzer's **FREQUENCY REFERENCE OUTPUT** connector as shown in Figure 2-14.

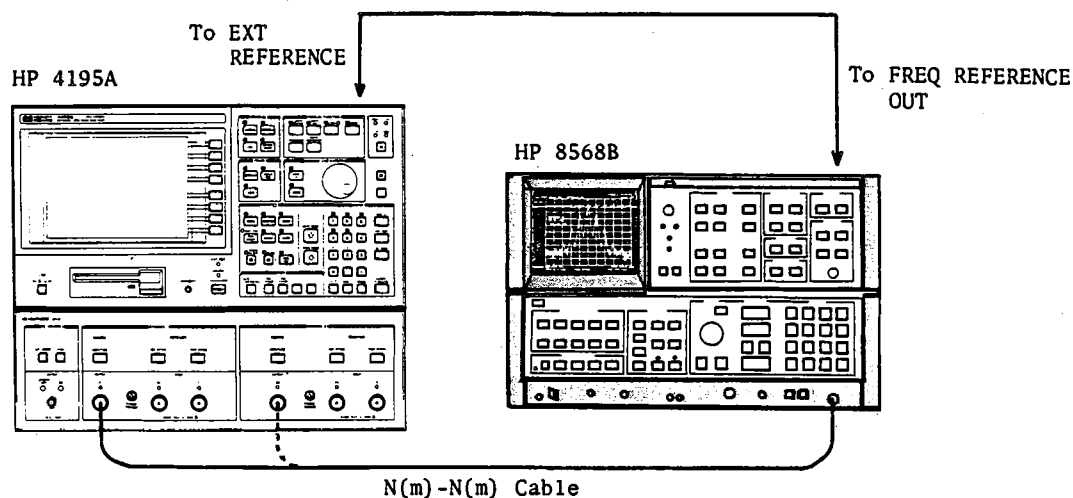

Figure 2-14. Non-Harmonic Spurious Test Setup

PERFORMANCE TESTS

3. Set the HP 4195A **CENTER FREQUENCY** and the Spectrum Analyzer **CENTER FREQUENCY**, and **FREQUENCY SPAN** as follows, and record the Spectrum Analyzer reading for each Center Frequency on the Calculation Sheet.

HP 4195A CENTER FREQUENCY	SPECTRUM ANALYZER CENTER FREQUENCY FREQUENCY SPAN	
123 MHz	123 MHz 123.666 MHz	2 MHz
140 MHz	140 MHz 153.333 MHz	30 MHz

4. Disconnect the N(m)-N(m) Cable from HP 4195A **OUTPUT S1**, and connect it to **OUTPUT S2**.
5. Change the HP 4195A settings as follows, and repeat step 3.

COMMAND		
INPUT PORT	T2/R2	PORT5
SOURCE AMPLITUDE (S2)	10 dBm	OSC2= 10

6. Use the equation given on the Calculation Sheet to calculate the test results, and record the test results in the Performance Test Record.

2-19. PHASE NOISE TEST

This test measures the HP 4195A's signal source Phase Noise. A spectrum analyzer is used to determine the phase noise which broadens the carrier spectrum.

SPECIFICATION:

Phase Noise < -100 dBc/Hz (at 20 kHz offset) ¹
 < -90 dBc/Hz (at 20 kHz offset)

¹: Applies only HP 4195A instruments serial number prefixed 2904J- and above.

EQUIPMENT:

Spectrum Analyzer	HP 8568B
N(m)-N(m) Cable, 61 cm	HP 11500B
BNC(m)-BNC(m) Cable, 122 cm	PN 8120-1840

PROCEDURE:

1. Set up the HP 4195A as follows.

	COMMAND
CONFIGURATION	NETWORK FNC1
INITIALIZE	PRESET RST
SOURCE AMPLITUDE (S1)	10 dBm OSC1= 10
CENTER	320.1 MHz CENTER= 320.1 M
SPAN	0 Hz SPAN= 0

2. Connect the N(m)-N(m) Cable between HP 4195A OUTPUT S1 and the Spectrum Analyzer SIGNAL INPUT 2, and connect the BNC(m)-BNC(m) cable between HP 4195A's EXT REFERENCE connector and the spectrum analyzer's FREQUENCY REFERENCE OUTPUT connector as shown in Figure 2-15.

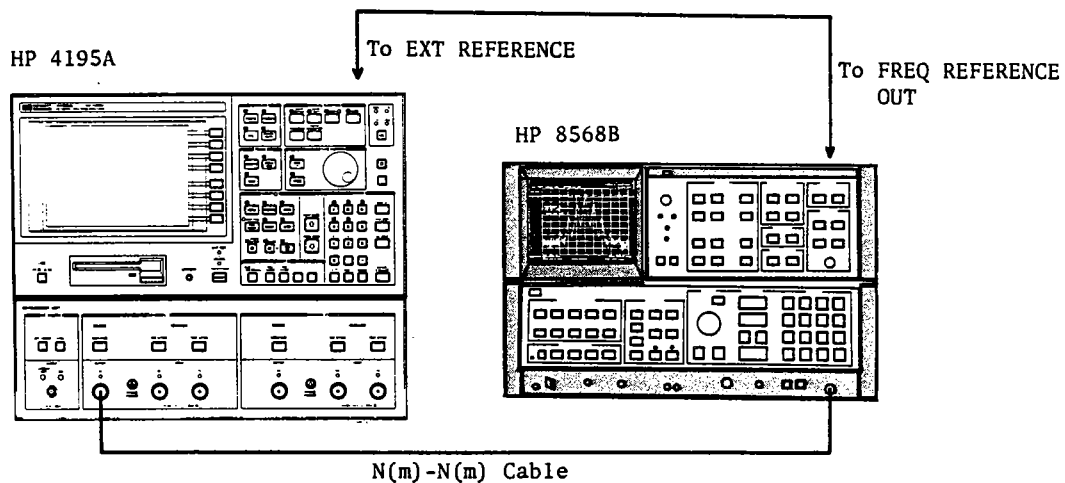

Figure 2-15. Phase Noise Test Setup
 2-32

PERFORMANCE TESTS

3. Set the Spectrum Analyzer as follows.

CENTER FREQUENCY	320.1 MHz
FREQUENCY SPAN	100 kHz
RES BW	100 Hz

4. Record the Spectrum Analyzer reading at **CENTER FREQUENCY** into Calculation Sheet column [a].
5. Record the Spectrum Analyzer reading at the ± 20 kHz frequency points of the **CENTER FREQUENCY** into Calculation Sheet Column [b].
6. Change the HP 4195A **CENTER FREQUENCY** and the Spectrum Analyzer **CENTER FREQUENCY** to 500 MHz, and repeat steps 4 and 5.
7. Use the equation given on the Calculation Sheet to calculate the test results, and record the test results in the Performance Test Record.

2-20 CROSSTALK TEST

This tests the signal leakage interference between the HP 4195A's two inputs when one input is driven and the other is terminated.

SPECIFICATION:

Cross Talk Level	< -100 dB (at \leq 400 MHz)
	< -90 dB (at $>$ 400 MHz)

EQUIPMENT:

N(m)-N(m) Cable, 61 cm	HP 11500B
50 Ω Termination	HP 909C Opt.012

PROCEDURE:

1. Set up the HP 4195A as follows.

CONFIGURATION	NETWORK	COMMAND
INITIALIZE	PRESET	FNC1
SWEEP TRIGGER MODE	SINGLE	RST
SOURCE AMPLITUDE (S1)	15 dBm	SWM2
INPUT ATTENUATOR (R1)	40 dB	OSC1= 15
INPUT ATTENUATOR (T1)	0 dB	ATR1= 40
INPUT ATTENUATOR (R2)	0 dB	ATT1= 0
INPUT ATTENUATOR (T2)	0 dB	ATR2= 0
		ATT2= 0

2. Connect an N(m)-N(m) Cable between HP 4195A **OUTPUT S1** and **INPUT R1**, and connect a 50 Ω Termination to **INPUT T1**, as shown in Figure 2-16.

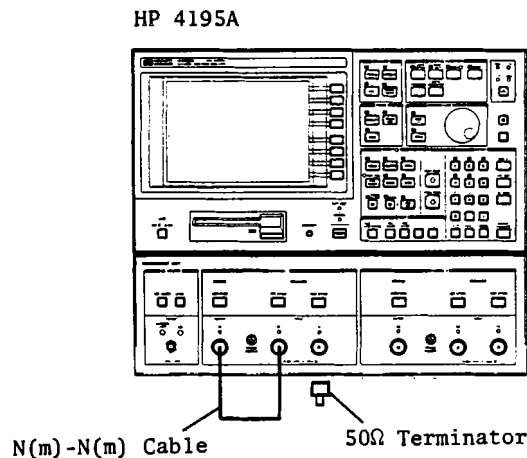

Figure 2-16. Crosstalk Test Setup

PERFORMANCE TESTS

3. Set up the HP 4195A as follows.

		COMMAND
START	100 Hz	START= 100
STOP	400 MHz	STOP= 400 M
RES BW	10 Hz	RBW= 10
SWEEP RESOLUTION	No. of POINTS = 51	NOP= 51
SWEEP TYPE	LOG	SWT2

4. Press the **TRIG/RESET** key, and wait until the single sweep is completed. Press **MKR→**, '**MKR→MAX**' to find the maximum value (worst-case crosstalk value) of HP 4195A data A (T/R), and record the value on the Performance Test Record.

5. Change the HP 4195A settings as follows.

		COMMAND
START	400 MHz	START= 400 M
STOP	500 MHz	STOP= 500 M
RES BW	300 Hz	RBW= 300
SWEEP RESOLUTION	No. of POINTS = 401	NOP= 401
SWEEP TYPE	LINEAR	SWT1

6. Press the **TRIG/RESET** key, and record the maximum data A (T/R) value of the HP 4195A reading in the Performance Test Record.
7. Disconnect the 50 Ω Termination from HP 4195A **INPUT T1** and connect it to **INPUT R2**.
8. Set HP 4195A **INPUT PORT** to **R2/R1**. Repeat steps 3 through 6.
9. Disconnect the 50 Ω Termination from **INPUT R2** and connect it to **INPUT T2**.
10. Set the HP 4195A **INPUT PORT** to **T2/R1**. Repeat steps 3 through 6.
11. Disconnect the N(m)-N(m) Cable and the 50 Ω Termination from the HP 4195A, connect the N(m)-N(m) Cable between HP 4195A **OUTPUT S2** and **INPUT R2**, and connect the 50 Ω Termination to **INPUT T1**.
12. Change the HP 4195A settings as follows. Repeat steps 3 through 6.

		COMMAND
INPUT PORT	T1/R2	PORT4
INPUT ATTENUATOR (R1)	0 dB	ATR1= 0
INPUT ATTENUATOR (R2)	40 dB	ATR2= 40
SOURCE AMPLITUDE (S2)	15 dB	OSC2= 15

13. Disconnect the 50 Ω Termination from **INPUT T1**, and connect it to **INPUT T2**.
14. Set the HP 4195A **INPUT PORT** to **T2/R2**. Repeat steps 3 through 6.

2-21. MAGNITUDE RATIO/PHASE DYNAMIC ACCURACY TEST

This test determines the HP 4195A's Dynamic Accuracy. The dynamic accuracy is a measure of how well the receiver measure the magnitude and phase components of a signal as that signal varies in amplitude over the specified dynamic range.

SPECIFICATION:

Magnitude Ratio:

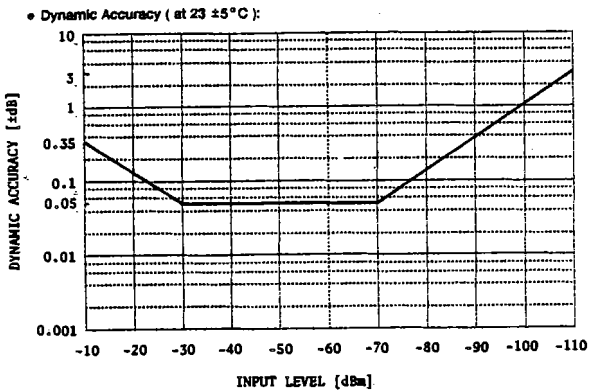

Phase:

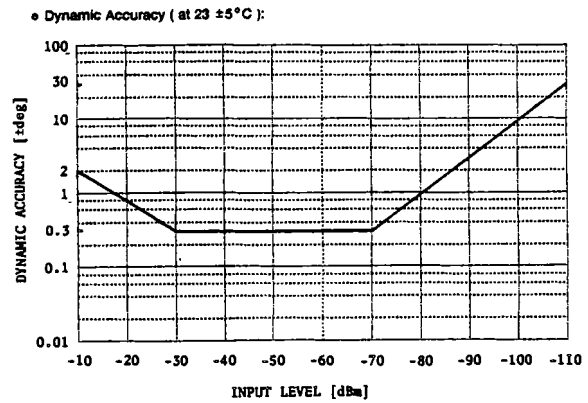

Where IF Range: Normal mode
 Attenuators: 0 dB
 Reference Input Level: -30 dBm
 Resolution Band Width: 10 Hz

EQUIPMENT:

Power Splitter
 Step Attenuator (calibrated)
 Attenuator Pad 6 dB
 Attenuator Pad 6 dB
 Attenuator Pad 10 dB
 Attenuator Pad 10 dB
 N(m)-N(m) Cable, 61 cm
 N(m)-N(m) Adapter

HP 11667A
 HP 8496A/G Opt.001 & H60
 HP 8491A Opt.006 & H60
 HP 8491A Opt.006
 HP 8491A Opt.010 & H60
 HP 8491A Opt.010
 HP 11500B 3 ea.
 PN 1250-1475

PROCEDURE:

1. Record the Step Attenuator 50 MHz Calibration Value on the Calculation Sheet.

2. Set up the HP 4195A as follows.

CONFIGURATION	NETWORK	COMMAND
INITIALIZE	PRESET	FNC1
SWEEP MODE	SINGLE	RST
SWEEP RESOLUTION	No. of POINTS = 2	SWM2
START	3 MHz	NOP=2
STOP	49.999 MHz	START= 3 M
RES BW	10 Hz	STOP= 49.999 M
VIDEO FILTER	ON	RBW= 10
INPUT ATTENUATOR	all 0 dB	VFTR1
		ATR1= 0
		ATT1= 0
		ATR2= 0
		ATT2= 0

3. Connect a Power Splitter, Step Attenuator, and Attenuator Pads to the HP 4195A, as shown in Figure 2-17.

NOTE

Use the Pads with Opt.H60 for the Step Attenuator path.

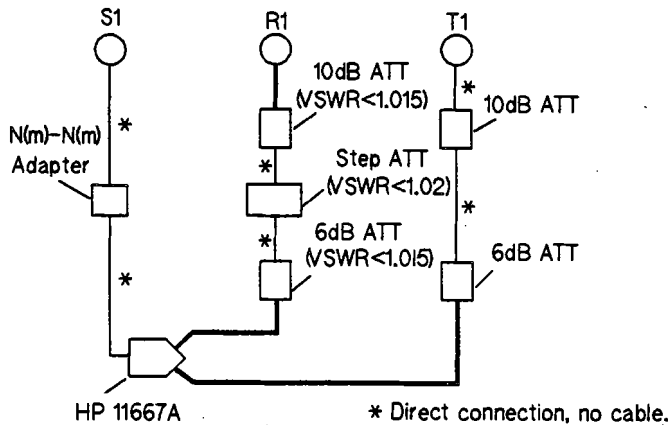

Figure 2-17. Magnitude Ratio/Phase Dynamic Accuracy Test Setup (1 of 2)

4. Set the Step Attenuator to 0 dB, and the HP 4195A SOURCE AMPLITUDE to -8 dBm.

NOTE

The signal amplitude applied to HP 4195A INPUTs R1 (or R2) must be -30 dBm.

5. In order to perform a THROUGH calibration, press CAL, 'TRANS CAL menu', 'NORMLIZE(THRU)', 'THRU', and ENTER/EXECUTE keys. After single sweep is completed, press CAL, 'CORRECTN on off' so that 'on' is intensified green.

6. Set the Step Attenuator to 20 dB, and the HP 4195A SOURCE AMPLITUDE to +12 dBm.

7. Press the **TRIG/RESET** key, and wait until the single sweep measurement is completed.
8. Move the o marker to the 3 MHz frequency point, and record the HP 4195A data B (θ) value on the Calculation Sheet **PHASE** column.
9. Move the o marker to the 49.999 MHz frequency point, and record the HP 4195A data A (T/R) value on the Calculation Sheet.
10. Set the Step Attenuator to 10 dB, and the HP 4195A **SOURCE AMPLITUDE** to +2 dBm, and repeat steps 7 through 9.
11. Set the HP 4195A **SOURCE AMPLITUDE** to -8 dBm.
12. Swap the cables connected to the HP 4195A **INPUTS**, as shown in Figure 2-18, and repeat steps 4 and 5 (**THRU CAL**).

NOTE

Use the Pads with Opt.H60 for the Step Attenuator path.

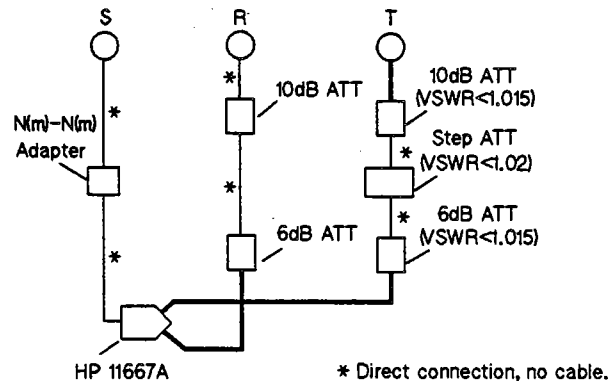

Figure 2-18. Magnitude Ratio/Phase Dynamic Accuracy Test Setup (2 of 2)

13. Set the Step Attenuator from 10 dB to 80 dB in 10 dB steps, and repeat steps 7 through 9 for every attenuation.
14. Change the HP 4195A **INPUT PORT** to R2/R1 ("PORT3").
15. Disconnect the cable from **INPUT R1** and connect it to **INPUT R2**, and disconnect the cable from **INPUT T1** and connect it to **INPUT R1**.
16. Repeat steps 4 through 13.
17. Change HP 4195A **INPUT PORT** to T2/R2 ("PORT5").
18. Disconnect the cable from the HP 4195A **INPUT R1**, and connect it to **INPUT T2**, and disconnect the cable from **OUTPUT S1**, and connect it to **OUTPUT S2**.
19. Repeat steps 4 through 13.
20. Use the equation given on the Calculation Sheet to calculate the test results, and transcribe the test results to the Performance Test Record.

PERFORMANCE TESTS

2-22. MAGNITUDE RATIO/PHASE FREQUENCY RESPONSE TEST

This test determines the **Magnitude Ratio** according for each pair of inputs by measuring the peak-to-peak variation of the ratioed trace. It also determines the phase tracking frequency response, measured as the deviation from linear phase.

SPECIFICATION:

Magnitude Ratio	$< \pm 1 \text{ dB } (\leq 200 \text{ MHz})$ $< \pm 1.5 \text{ dB } (> 200 \text{ MHz})$
	Where the Input Attenuators for two inputs must be the same value, respectively.
Phase (deviation from linear)	$< \pm 5^\circ (\leq 200 \text{ MHz})$ $< \pm 7.5^\circ (> 200 \text{ MHz})$
	Where the Input Attenuators for two inputs must be the same value, respectively.

EQUIPMENT:

Power Splitter	HP 11667A	
N(m)-N(m) Cable, 61 cm	HP 11500B	2 ea.
Adapter N(m)-N(m)	HP PN 1250-0778	

PROCEDURE:

1. Set up the HP 4195A as follows.

		COMMAND
CONFIGURATION	NETWORK	FNC1
INITIALIZE	PRESET	RST
RES BW	3 kHz	RBW= 3 K
SOURCE AMPLITUDE (S1)	-4 dBm	OSC1= -4
SOURCE AMPLITUDE (S2)	-4 dBm	OSC2= -4

2. Connect the cables and the Power Splitter associated with the Adapter to the HP 4195A as shown in Figure 2-19.

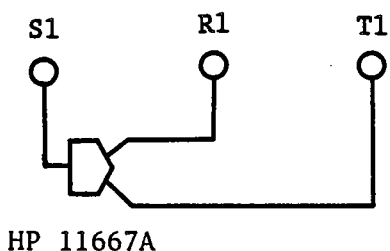

Figure 2-19. Magnitude Ratio/Phase Frequency Response Test Setup (1 of 3)

PERFORMANCE TESTS

3. Set both **INPUT ATTENUATORS** to **0 dB**.
4. Set the HP 4195A as follows.

		COMMAND
SWEEP TYPE	LOG	SWT2
SWEEP TRIGGER MODE	CONT	SWM1
START	1MHz	START= 1 M
STOP	200MHz	STOP= 200 M

5. Set the trace scale (reference level and bottom level) as follows.

		COMMAND
Reference Level (A)	1.5 dBm	SCL1; REF= 1.5
Bottom Level (A)	-1.5 dBm	SCL1; BTM= -1.5
Reference Level (B)	7.5 deg	SCL2; REF= 7.5
Bottom Level (B)	-7.5 deg	SCL2; BTM= -7.5

6. Press the **CAL** key. Press the '**PORT EXT on off**' softkey so that **on** is intensified green.
7. Press the '**PORT EXTENS**', and '**INPUT R1**' softkey.
8. Vary the R1-port extension length value **PER1** until the trace **B** (θ) is in the most horizontal position, refer to the following NOTE.

NOTE

To make trace **B** as horizontal as possible, the phase (θ) difference between the two inputs must be eliminated using the port extension capability. An appropriate port extension length can be obtained in the following manner.

Read the phase (θ) at 200 MHz (most right side) by moving the **o** (manual) marker. The port extension length is nearly equal to (θ reading \times 0.42).

9. Press **TRIG/RESET**, and '**SINGLE mode**' to pause the sweep.
10. Find the maximum absolute point (peak or valley, depending on the polarity) of data **A** (T/R) by using '**MKR→MAX**' or '**MKR→MIN**' softkey. Then record the value at this point in the **MAGNITUDE RATIO** column of the Performance Test Record.

NOTE

Press **MKR→** key to use the '**MKR→MAX**' and '**MKR→MIN**' function. '**MKR→forAforB**' softkey selects the objective data for the marker.

11. Find the maximum absolute point of data **B** (θ) in a similar manner to step 10. Record the value at this point into the **PHASE** column of the Performance Test Record.

PERFORMANCE TESTS

12. Press the **CAL** key, '**PORT EXTENS**', and '**INPUT R1**' softkeys, then zero **PER1** zero by pressing **0**, and the **ENTER/EXECUTE** key.
13. Set up the HP 4195A as follows.

COMMAND		
SWEEP TYPE	LIN	SWT1
SWEEP TRIGGER MODE	CONT	SWM1
START	200 MHz	START= 200 M
STOP	500 MHz	STOP= 500 M

14. Set the trace scale (reference level and bottom level) as follows.

COMMAND		
Reference Level (A)	2 dBm	SCL1; REF= 2
Bottom Level (A)	-2 dBm	SCL1; BTM= -2
Reference Level (B)	11 deg	SCL2; REF= 11
Bottom Level (B)	-11 deg	SCL2; BTM= -11

15. Press **CAL** key, and the '**PORT EXTENS**' softkey, then press the '**INPUT R1**' softkey. Vary the R1-port extension length value **PER1** until trace **B** (θ) is in the most horizontal position, refer to the following **NOTE** and step 8.

NOTE

Read the phase (θ) at 500 MHz (most right side) by moving the o marker. The R1-port extension length (**PER1**) is nearly equal to (θ reading \times 0.17).

16. Press **TRIG/RESET**, and '**SINGLE mode**' to pause the sweep.
17. Referring to step 10, find the maximum absolute point of data A (T/R) by using the '**MKR→MAX**' or '**MKR→MIN**' softkeys. Then record the value at this point in the **MAGNITUDE RATIO** column of the Performance Test Record.
18. Find the maximum absolute point of data B (θ) and record the value at this point in the **PHASE** column of the Performance Test Record.
19. Press the **CAL** key, and the '**PORT EXTENS**' softkey, then press the '**INPUT R1**' softkey, then zero R1 by pressing the **0**, **ENTER/EXECUTE** keys.
20. Set both **INPUT ATTENUATORS** to **10 dB**. Then perform steps 4 through 19.
21. Set both **INPUT ATTENUATORS** to **20 dB**. Then perform steps 4 through 19.
22. Set both **INPUT ATTENUATORS** to **40 dB**. Then perform steps 4 through 19.
23. Press **CONFIG**, '**PORT SELECT**', '**R2/R1**' to change the input port.
24. Disconnect the cable from **INPUT T1**, then connect it to **INPUT R2** as shown in Figure 2-20.

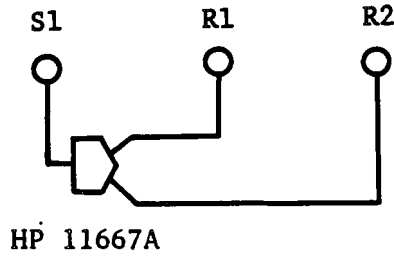

Figure 2-20. Magnitude Ratio/Phase Frequency Response Test Setup (2 of 3)

25. Repeat steps 3 through 22.
26. Press **CONFIG**, **'PORT SELECT'**, and **'T2/R2'** to change the input port.
27. Disconnect the cable from **INPUT R1**, and connect it to **INPUT T2** as shown in Figure 2-21, and disconnect the adapter associated with the power splitter from **OUTPUT S1**, and connect it to **OUTPUT S2**. Repeat steps 3 through 22.
28. Repeat steps 3 through 22.

NOTE

The port extension length **R2 (PER2)** should be used instead of **R1 (PER1)** in steps 7, 8, 12, 15 and 19.

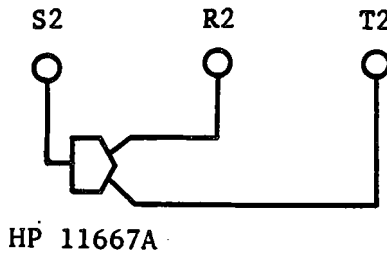

Figure 2-21. Magnitude Ratio/Phase Frequency Response Test Setup (3 of 3)

PERFORMANCE TESTS

2-23. DC SOURCE VOLTAGE ACCURACY TEST

This test confirms that the DC Source Output Voltage supplied by the HP 4195A is within specification. The output voltage is checked at DC bias settings of -40 V through 40 V in 10 V steps.

SPECIFICATION:

DC Bias Level Accuracy $\pm(0.12\% + 5 \text{ mV})$

EQUIPMENT:

Digital Voltmeter	HP 3456A
BNC(m)-BNC(m) Cable, 61 cm	PN 8120-1839
BNC(f)-Dual Banana Plug Adapter	PN 1251-2277

PROCEDURE:

1. Set up the HP 4195A as follows.

		COMMAND
CONFIGURATION	NETWORK	FNC1
INITIALIZE	PRESET	RST
SWEEP PARAMETER	DC BIAS	SWP2
SWEEP TRIGGER MODE	MANUAL	SWM3
START	-40 V	START= -40 V
STOP	40 V	STOP= 40 V
STEP SIZE	10 V	STEP= 10 V

NOTE

The STEP SIZE can be set by pressing MENU, 'RESOLUTN menu', and 'STEP SIZE'.

2. Connect the Digital Voltmeter to the HP 4195A, as shown in Figure 2-22.

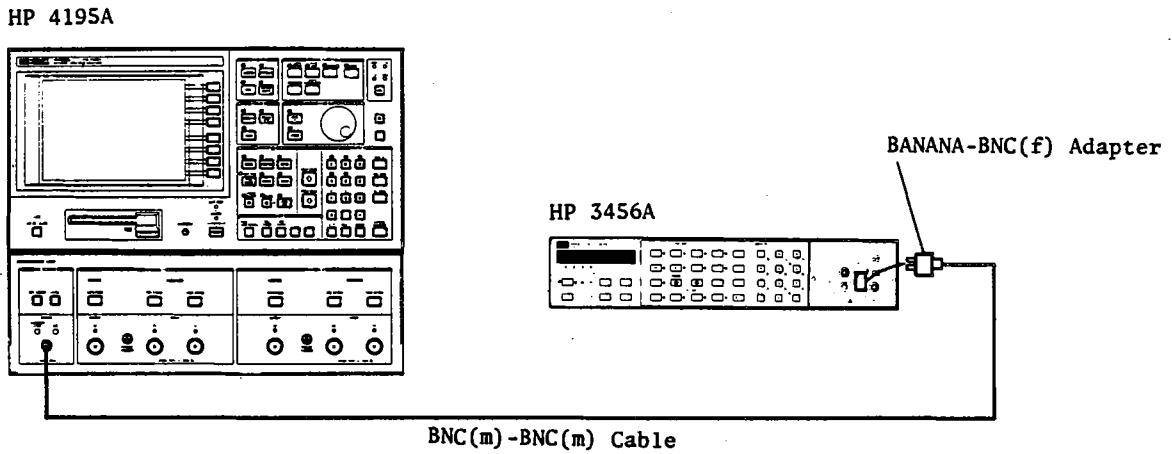

Figure 2-22. DC Voltage Accuracy Test Setup

3. Move the o marker (MANUAL point) to the -40 V point.
4. Record the Digital Voltmeter reading in the Performance Test Record.
5. Move the o marker (MANUAL point) to the following points, and repeat step 4, for every marker settings.

o MARKER POSITION
-30 V
-20 V
-10 V
0 V
10 V
20 V
30 V
40 V

CALCULATION SHEET

2-8. AMPLITUDE MEASUREMENT ACCURACY TEST

STEP ATTENUATOR CALIBRATION VALUE (at 50 MHz):

NOMINAL	CALIBRATION [a]
10 dB	[a1= dB]
20 dB	[a2= dB]
30 dB	[a3= dB]
40 dB	[a4= dB]
50 dB	[a5= dB]

POWER METER READING:

[b= dBm]

TEST RESULTS:

INPUT PORT	INPUT ATTENUATOR	IF RANGE	INPUT RANGE	STEP ATTENUATOR	HP 4195A DATA A [c]	TEST RESULT
R1	10 dB	NORM	-10 dBm	20 dB	[dBm]	a2-b+c
R1	10 dB	LO DISTN	-20 dBm	30 dB	[dBm]	a3-b+c
R1	0 dB	HI SENS	-40 dBm	50 dB	[dBm]	a5-b+c
R1	10 dB	HI SENS	-30 dBm	40 dB	[dBm]	a4-b+c
R1	20 dB	HI SENS	-20 dBm	30 dB	[dBm]	a3-b+c
R1	30 dB	HI SENS	-10 dBm	20 dB	[dBm]	a2-b+c
R1	40 dB	HI SENS	0 dBm	10 dB	[dBm]	a1-b+c
R1	50 dB	HI SENS	10 dBm	0 dB	[dBm]	-b+c
T1	0 dB	HI SENS	-40 dBm	50 dB	[dBm]	a5-b+c
T1	10 dB	HI SENS	-30 dBm	40 dB	[dBm]	a4-b+c
T1	20 dB	HI SENS	-20 dBm	30 dB	[dBm]	a3-b+c
T1	30 dB	HI SENS	-10 dBm	20 dB	[dBm]	a2-b+c
T1	40 dB	HI SENS	0 dBm	10 dB	[dBm]	a1-b+c
T1	50 dB	HI SENS	10 dBm	0 dB	[dBm]	-b+c
R2	0 dB	HI SENS	-40 dBm	50 dB	[dBm]	a5-b+c
R2	10 dB	HI SENS	-30 dBm	40 dB	[dBm]	a4-b+c
R2	20 dB	HI SENS	-20 dBm	30 dB	[dBm]	a3-b+c
R2	30 dB	HI SENS	-10 dBm	20 dB	[dBm]	a2-b+c
R2	40 dB	HI SENS	0 dBm	10 dB	[dBm]	a1-b+c
R2	50 dB	HI SENS	10 dBm	0 dB	[dBm]	-b+c
T2	0 dB	HI SENS	-40 dBm	50 dB	[dBm]	a5-b+c
T2	10 dB	HI SENS	-30 dBm	40 dB	[dBm]	a4-b+c
T2	20 dB	HI SENS	-20 dBm	30 dB	[dBm]	a3-b+c
T2	30 dB	HI SENS	-10 dBm	20 dB	[dBm]	a2-b+c
T2	40 dB	HI SENS	0 dBm	10 dB	[dBm]	a1-b+c
T2	50 dB	HI SENS	10 dBm	0 dB	[dBm]	-b+c

2-9. AMPLITUDE MEASUREMENT LINEARITY TEST

ATTENUATOR VALUE		HP 4195A	HP 4195A	TEST RESULT
NOMINAL	CALIBRATION ¹	INPUT LEVEL ²	DATA A	[-a+b+c]
	[b]		[c]	
0 dB		reference	[a= dBm]	
10 dB	[dB]	-10 dB	[dBm]	[dB]
20 dB	[dB]	-20 dB	[dBm]	[dB]
30 dB	[dB]	-30 dB	[dBm]	[dB]
40 dB	[dB]	-40 dB	[dBm]	[dB]
50 dB	[dB]	-50 dB	[dBm]	[dB]
60 dB	[dB]	-60 dB	[dBm]	[dB]
70 dB	[dB]	-70 dB	[dBm]	[dB]
80 dB	[dB]	-80 dB	[dBm]	[dB]

Note: ¹ Use the step attenuator's 50 MHz calibration value listed in the Calibration Report.

² The INPUT LEVEL is relative to the reference: -30 dBm.

2-10. AMPLITUDE MEASUREMENT FREQUENCY RESPONSE TEST

INPUT PORT: R1

HP 4195A	HP 4195A	HP 3456A	TEST RESULT
CENTER FREQUENCY	DATA A	READING	[a-b+c-d-e+f]
10 Hz	[a= dBm]	[b= dBm]	[dB]
100 kHz		[c= dBm]	

HP 4195A	HP 4195A	POWER METER	TEST RESULT
CENTER FREQUENCY	DATA A	READING	[a-b-e+f]
	[a]	[b]	
100 kHz	[dBm]	[d= dBm]	[dB]
50 MHz	[e= dBm]	[f= dBm]	
9.99 MHz	[dBm]	[dBm]	[dB]
10 MHz	[dBm]	[dBm]	[dB]
149.99 MHz	[dBm]	[dBm]	[dB]
150 MHz	[dBm]	[dBm]	[dB]
224.99 MHz	[dBm]	[dBm]	[dB]
225 MHz	[dBm]	[dBm]	[dB]
339.99 MHz	[dBm]	[dBm]	[dB]
340 MHz	[dBm]	[dBm]	[dB]
500 MHz	[dBm]	[dBm]	[dB]

CALCULATION SHEET

INPUT PORT: T1

HP 4195A CENTER FREQUENCY	HP 4195A DATA A	HP 3456A READING	TEST RESULT [a-b+c-d-e+f]
10 Hz	[a= dBm]	[b= dBm]	[dB]
100 kHz		[c= dBm]	

HP 4195A CENTER FREQUENCY	HP 4195A DATA A [a]	POWER METER READING [b]	TEST RESULT [a-b-e+f]
100 kHz	[dBm]	[d= dBm]	[dB]
50 MHz	[e= dBm]	[f= dBm]	
10 MHz	[dBm]	[dBm]	[dB]
150 MHz	[dBm]	[dBm]	[dB]
225 MHz	[dBm]	[dBm]	[dB]
340 MHz	[dBm]	[dBm]	[dB]
500 MHz	[dBm]	[dBm]	[dB]

INPUT PORT: R2

HP 4195A CENTER FREQUENCY	HP 4195A DATA A	HP 3456A READING	TEST RESULT [a-b+c-d-e+f]
10 Hz	[a= dBm]	[b= dBm]	[dB]
100 kHz		[c= dBm]	

HP 4195A CENTER FREQUENCY	HP 4195A DATA A [a]	POWER METER READING [b]	TEST RESULT [a-b-e+f]
100 kHz	[dBm]	[d= dBm]	[dB]
50 MHz	[e= dBm]	[f= dBm]	
10 MHz	[dBm]	[dBm]	[dB]
150 MHz	[dBm]	[dBm]	[dB]
225 MHz	[dBm]	[dBm]	[dB]
340 MHz	[dBm]	[dBm]	[dB]
500 MHz	[dBm]	[dBm]	[dB]

CALCULATION SHEET

INPUT PORT: T2

HP 4195A CENTER FREQUENCY	HP 4195A DATA A	HP 3456A READING	TEST RESULT [a-b+c-d-e+f]
10 Hz	[a= dBm]	[b= dBm]	[dB]
100 kHz		[c= dBm]	

HP 4195A CENTER FREQUENCY	HP 4195A DATA A [a]	POWER METER READING [b]	TEST RESULT [a-b-e+f]
100 kHz	[dBm]	[d= dBm]	[dB]
50 MHz	[e= dBm]	[f= dBm]	
10 MHz	[dBm]	[dBm]	[dB]
150 MHz	[dBm]	[dBm]	[dB]
225 MHz	[dBm]	[dBm]	[dB]
340 MHz	[dBm]	[dBm]	[dB]
500 MHz	[dBm]	[dBm]	[dB]

2-11. SECOND HARMONIC DISTORTION TEST

CENTER FREQUENCY	HP 4195A DATA A
50 MHz	[a= dBm]
100 MHz	[b= dBm]
TEST RESULT [-a+b]	[dBc]

2-12. THIRD ORDER INTERMODULATION DISTORTION TEST

CENTER FREQUENCY	HP 4195A DATA A [b]	TEST RESULT [-a+b]
F= 2.02 MHz	2.02 MHz	[a= dBm]
	1.52 MHz	[dBm]
	3.02 MHz	[dBm]
		[dBc]
		[dBc]
F= 5.02 MHz	5.52 MHz	[a= dBm]
	4.52 MHz	[dBm]
	6.02 MHz	[dBm]
		[dBc]
		[dBc]
F= 10.20 MHz	10.20 MHz	[a= dBm]
	9.70 MHz	[dBm]
	11.20 MHz	[dBm]
		[dBc]
		[dBc]
F= 20.20 MHz	20.20 MHz	[a= dBm]
	19.70 MHz	[dBm]
	21.20 MHz	[dBm]
		[dBc]
		[dBc]
F= 50.20 MHz	50.20 MHz	[a= dBm]
	49.70 MHz	[dBm]
	51.20 MHz	[dBm]
		[dBc]
		[dBc]
F= 100.20 MHz	100.20 MHz	[a= dBm]
	99.70 MHz	[dBm]
	101.20 MHz	[dBm]
		[dBc]
		[dBc]
F= 200.20 MHz	200.20 MHz	[a= dBm]
	199.70 MHz	[dBm]
	201.20 MHz	[dBm]
		[dBc]
		[dBc]
F= 490.20 MHz	490.20 MHz	[a= dBm]
	498.70 MHz	[dBm]
		[dBc]

2-14. LEVEL ACCURACY/FLATNESS TEST

OUTPUT PORT: S1

HP 4195A CENTER FREQUENCY	HP 3456A READING [a]	TEST RESULT [a-b+c-d]
10 Hz	[dBm]	[dB]
100 Hz	[dBm]	[dB]
1 kHz	[dBm]	[dB]
10 kHz	[dBm]	[dB]
100 kHz	[b= dBm]	

HP 4195A CENTER FREQUENCY	POWER METER READING [a]	TEST RESULT [a-d]
100 kHz	[c= dBm]	[dB]
50 MHz	[d= dBm]	
1 MHz	[dBm]	[dB]
9.99 MHz	[dBm]	[dB]
10 MHz	[dBm]	[dB]
149.9 MHz	[dBm]	[dB]
150 MHz	[dBm]	[dB]
192 MHz	[dBm]	[dB]
224.9 MHz	[dBm]	[dB]
225 MHz	[dBm]	[dB]
300 MHz	[dBm]	[dB]
339.9 MHz	[dBm]	[dB]
340 MHz	[dBm]	[dB]
420 MHz	[dBm]	[dB]
500 MHz	[dBm]	[dB]

CALCULATION SHEET

OUTPUT PORT: S2

HP 4195A CENTER FREQUENCY	HP 3456A READING [a]	TEST RESULT [a-b+c-d]
10 Hz	[dBm]	[dB]
100 Hz	[dBm]	[dB]
1 kHz	[dBm]	[dB]
10 kHz	[dBm]	[dB]
100 kHz	[b= dBm]	

HP 4195A'S CENTER FREQUENCY	POWER METER'S READING [a]	TEST RESULT [a-d]
100 kHz	[c= dBm]	[dB]
50 MHz	[d= dBm]	
1 MHz	[dBm]	[dB]
9.99 MHz	[dBm]	[dB]
10 MHz	[dBm]	[dB]
149.9 MHz	[dBm]	[dB]
150 MHz	[dBm]	[dB]
192 MHz	[dBm]	[dB]
224.9 MHz	[dBm]	[dB]
225 MHz	[dBm]	[dB]
300 MHz	[dBm]	[dB]
339.9 MHz	[dBm]	[dB]
340 MHz	[dBm]	[dB]
420 MHz	[dBm]	[dB]
500 MHz	[dBm]	[dB]

2-15. NON-SWEEP LINEARITY

OUTPUT PORT : S1

R1	OUTPUT LEVEL	HP 4195A DATA A		TEST RESULT
ATTENUATOR	[a]	[b]		
40 dB	10 dBm	[c=	dBm]	-a+b-c+10
	5 dBm	[dBm]	[dB]
	0 dBm	[d=	dBm]	[dB]
30 dB	0 dBm	[e=	dBm]	-a+b-(c-d+e-10)
	-5 dBm	[dBm]	[dB]
	-10 dBm	[dBm]	[dB]
	-15 dBm	[dBm]	[dB]
	-20 dBm	[dBm]	[dB]
	-25 dBm	[dBm]	[dB]
	-30 dBm	[dBm]	[dB]
	-35 dBm	[dBm]	[dB]

OUTPUT PORT : S2

R1	OUTPUT LEVEL	HP 4195A DATA A		TEST RESULT
ATTENUATOR	[a]	[b]		
40 dB	10 dBm	[c=	dBm]	-a+b-c+10
	5 dBm	[dBm]	[dB]
	0 dBm	[d=	dBm]	[dB]
30 dB	0 dBm	[e=	dBm]	-a+b-(c-d+e-10)
	-5 dBm	[dBm]	[dB]
	-10 dBm	[dBm]	[dB]
	-15 dBm	[dBm]	[dB]
	-20 dBm	[dBm]	[dB]
	-25 dBm	[dBm]	[dB]
	-30 dBm	[dBm]	[dB]
	-35 dBm	[dBm]	[dB]

CALCULATION SHEET

2-16. POWER SWEEP LINEARITY

ATTENUATOR CALIBRATION VALUE: (at 50 MHz)

NOMINAL VALUE	CALIBRATION VALUE
10 dB	[a1= dB]
20 dB	[a2= dB]

TEST RESULTS:

TEST POINT (OUTPUT LEVEL)	INPUT LEVEL	READING [b]	TEST RESULT
0 dBm	-10 dBm	[c= dBm]	
10 dBm	-10 dBm	[dBm]	-a1+a2+b-c-10 =[dB]
-5 dBm	-15 dBm	[c= dBm]	
5 dBm	-15 dBm	[dBm]	-a1+a2+b-c-10 =[dB]
-11 dBm	-21 dBm	[c= dBm]	
-1 dBm	-21 dBm	[dBm]	-a1+a2+b-c-10 =[dB]
-21 dBm	-21 dBm	[dBm]	-a1+b-c+10 =[dB]

2-17. SECOND HARMONICS TEST

OUTPUT PORT: S1

HP 4195A OUTPUT FREQUENCY	SPECTRUM ANALYZER CENTER FREQUENCY	READING	TEST RESULT [-a+b]
5 MHz	5 MHz	[a= dBm]	
	10 MHz	[b= dBm]	[dBc]
150 MHz	150 MHz	[a= dBm]	
	300 MHz	[b= dBm]	[dBc]
225 MHz	225 MHz	[a= dBm]	
	450 MHz	[b= dBm]	[dBc]
340 MHz	340 MHz	[a= dBm]	
	680 MHz	[b= dBm]	[dBc]

CALCULATION SHEET

OUTPUT PORT: S2

HP 4195A OUTPUT FREQUENCY	SPECTRUM ANALYZER CENTER FREQUENCY	READING	TEST RESULT [-a+b]
5 MHz	5 MHz	[a= dBm]	dBc]
	10 MHz	[b= dBm]	
150 MHz	150 MHz	[a= dBm]	dBc]
	300 MHz	[b= dBm]	
225 MHz	225 MHz	[a= dBm]	dBc]
	450 MHz	[b= dBm]	
340 MHz	340 MHz	[a= dBm]	dBc]
	680 MHz	[b= dBm]	

2-18. NON-HARMONIC SPURIOUS TEST

OUTPUT PORT: S1

HP 4195A OUTPUT FREQUENCY	SPECTRUM ANALYZER CENTER FREQUENCY	READING	TEST RESULT [-a+b]
123 MHz	123 MHz	[a= dBm]	dBc]
	123.666 MHz	[b= dBm]	
140 MHz	140 MHz	[a= dBm]	dBc]
	153.333 MHz	[b= dBm]	

OUTPUT PORT: S2

HP 4195A OUTPUT FREQUENCY	SPECTRUM ANALYZER CENTER FREQUENCY	READING	TEST RESULT [-a+b]
123 MHz	123 MHz	[a= dBm]	dBc]
	123.666 MHz	[b= dBm]	
140 MHz	140 MHz	[a= dBm]	dBc]
	153.333 MHz	[b= dBm]	

CALCULATION SHEET

2-19. PHASE NOISE TEST

HP 4195A CENTER FREQUENCY	SPECTRUM ANALYZER CENTER FREQUENCY	READING	TEST RESULT [-a+b-20]
320.1 MHz	320.10 MHz	[a= dBm]	
	320.08 MHz	[b= dBm] [dBc]
	320.12 MHz	[b= dBm] [dBc]
500 MHz	500.00 MHz	[a= dBm]	
	499.98 MHz	[b= dBm] [dBc]
	500.02 MHz	[b= dBm] [dBc]

2-20. MAGNITUDE RATIO/PHASE DYNAMIC ACCURACY TEST

STEP ATTENUATOR CALIBRATION VALUE: (at 50 MHz)

NOMINAL VALUE	CALIBRATION VALUE
10 dB	[a1= dB]
20 dB	[a2= dB]
30 dB	[a3= dB]
40 dB	[a4= dB]
50 dB	[a5= dB]
60 dB	[a6= dB]
70 dB	[a7= dB]
80 dB	[a8= dB]

INPUT PORT: T1/R1, OUTPUT PORT: S1

ATTENUATORS SETTING	HP 4195A DATA B (θ) (PHASE)	HP 4195A DATA A (T/R) [b]	TEST RESULT (MAG. RATIO)	HP 4195A INPUT LEVEL
R side 20 dB	[deg] [dB]	-a2+b	-10 dBm
10 dB	[deg] [dB]	-a1+b	-20 dBm
T side 10 dB	[deg] [dB]	a1+b	-40 dBm
20 dB	[deg] [dB]	a2+b	-50 dBm
30 dB	[deg] [dB]	a3+b	-60 dBm
40 dB	[deg] [dB]	a4+b	-70 dBm
50 dB	[deg] [dB]	a5+b	-80 dBm
60 dB	[deg] [dB]	a6+b	-90 dBm
70 dB	[deg] [dB]	a7+b	-100 dBm
80 dB	[deg] [dB]	a8+b	-110 dBm

CALCULATION SHEET

INPUT PORT: R2/R1, OUTPUT PORT: S1

ATTENUATOR SETTING	HP 4195A DATA B (θ) (PHASE)	HP 4195A DATA A (T/R) [b]	TEST RESULT (MAG. RATIO)	HP 4195A INPUT LEVEL
R side 20 dB	[deg]	[dB]	-a2+b	-10 dBm
10 dB	[deg]	[dB]	-a1+b	-20 dBm
T side 10 dB	[deg]	[dB]	a1+b	-40 dBm
20 dB	[deg]	[dB]	a2+b	-50 dBm
30 dB	[deg]	[dB]	a3+b	-60 dBm
40 dB	[deg]	[dB]	a4+b	-70 dBm
50 dB	[deg]	[dB]	a5+b	-80 dBm
60 dB	[deg]	[dB]	a6+b	-90 dBm
70 dB	[deg]	[dB]	a7+b	-100 dBm
80 dB	[deg]	[dB]	a8+b	-110 dBm

INPUT PORT: T2/R2, OUTPUT PORT: S2

ATTENUATOR SETTING	HP 4195A DATA B (θ) (PHASE)	HP 4195A DATA A (T/R) [b]	TEST RESULT (MAG. RATIO)	HP 4195A INPUT LEVEL
R side 20 dB	[deg]	[dB]	-a2+b	-10 dBm
10 dB	[deg]	[dB]	-a1+b	-20 dBm
T side 10 dB	[deg]	[dB]	a1+b	-40 dBm
20 dB	[deg]	[dB]	a2+b	-50 dBm
30 dB	[deg]	[dB]	a3+b	-60 dBm
40 dB	[deg]	[dB]	a4+b	-70 dBm
50 dB	[deg]	[dB]	a5+b	-80 dBm
60 dB	[deg]	[dB]	a6+b	-90 dBm
70 dB	[deg]	[dB]	a7+b	-100 dBm
80 dB	[deg]	[dB]	a8+b	-110 dBm

PERFORMANCE TEST RECORD

Hewlett-Packard
 Model HP 4195A
 Network/Spectrum Analyzer

Tested by: _____
 Date: _____
 Serial No.: _____
 Temperature: _____
 Humidity: _____

2-6. INTERNAL SYNTHESIZER FREQUENCY ACCURACY TEST

A. without OPTION 001

FREQUENCY	MINIMUM LIMIT	TEST RESULT	MAXIMUM LIMIT
100 MHz	99.998 00 MHz	_____	100.002 00 MHz
200 MHz	199.996 00 MHz	_____	200.004 00 MHz
320.1 MHz	320.093 60 MHz	_____	320.106 40 MHz
500 MHz	499.990 00 MHz	_____	500.010 00 MHz

B. with OPTION 001

FREQUENCY	MINIMUM LIMIT	TEST RESULT	MAXIMUM LIMIT
100 MHz	99 999 900 Hz	_____	100 000 100 Hz
200 MHz	199 999 800 Hz	_____	200 000 200 Hz
320.1 MHz	320 099 680 Hz	_____	320 100 320 Hz
500 MHz	499 999 500 Hz	_____	500 000 500 Hz

2-7. RESOLUTION BAND WIDTH ACCURACY TEST

RES BW	MINIMUM LIMIT	TEST RESULT	MAXIMUM LIMIT
100 Hz	90 Hz	_____	110 Hz
300 Hz	270 Hz	_____	330 Hz
1 kHz	900 Hz	_____	1100 Hz
3 kHz	2700 Hz	_____	3300 Hz
10 kHz	9 kHz	_____	11 kHz
30 kHz	27 kHz	_____	33 kHz
100 kHz	90 kHz	_____	110 kHz
300 kHz	270 kHz	_____	330 kHz

PERFORMANCE TEST RECORD

2-8. AMPLITUDE MEASUREMENT ACCURACY TEST

INPUT PORT: R1

	MINIMUM LIMIT	TEST RESULT	MAXIMUM LIMIT
IF RANGE: NORMAL			
INPUT RANGE: -10 dBm	-1.0 dB	_____	1.0 dB
IF RANGE: LOW DISTORTION			
INPUT RANGE: -20 dBm	-1.0 dB	_____	1.0 dB
IF RANGE: HIGH SENSITIVITY			
INPUT RANGE: -40 dBm	-1.0 dB	_____	1.0 dB
-30 dBm	-1.0 dB	_____	1.0 dB
-20 dBm	-1.0 dB	_____	1.0 dB
-10 dBm	-1.0 dB	_____	1.0 dB
0 dBm	-1.0 dB	_____	1.0 dB
10 dBm	-1.0 dB	_____	1.0 dB

INPUT PORT: T1

	MINIMUM LIMIT	TEST RESULT	MAXIMUM LIMIT
IF RANGE: HIGH SENSITIVITY			
INPUT RANGE: -40 dBm	-1.0 dB	_____	1.0 dB
-30 dBm	-1.0 dB	_____	1.0 dB
-20 dBm	-1.0 dB	_____	1.0 dB
-10 dBm	-1.0 dB	_____	1.0 dB
0 dBm	-1.0 dB	_____	1.0 dB
10 dBm	-1.0 dB	_____	1.0 dB

INPUT PORT: R2

	MINIMUM LIMIT	TEST RESULT	MAXIMUM LIMIT
IF RANGE: HIGH SENSITIVITY			
INPUT RANGE: -40 dBm	-1.0 dB	_____	1.0 dB
-30 dBm	-1.0 dB	_____	1.0 dB
-20 dBm	-1.0 dB	_____	1.0 dB
-10 dBm	-1.0 dB	_____	1.0 dB
0 dBm	-1.0 dB	_____	1.0 dB
10 dBm	-1.0 dB	_____	1.0 dB

INPUT PORT: T2

	MINIMUM LIMIT	TEST RESULT	MAXIMUM LIMIT
IF RANGE: HIGH SENSITIVITY			
INPUT RANGE: -40 dBm	-1.0 dB	_____	1.0 dB
-30 dBm	-1.0 dB	_____	1.0 dB
-20 dBm	-1.0 dB	_____	1.0 dB
-10 dBm	-1.0 dB	_____	1.0 dB
0 dBm	-1.0 dB	_____	1.0 dB
10 dBm	-1.0 dB	_____	1.0 dB

PERFORMANCE TEST RECORD

2-9. AMPLITUDE MEASUREMENT LINEARITY TEST

INPUT LEVEL	MINIMUM LIMIT	TEST RESULT	MAXIMUM LIMIT
-10 dB	-0.1 dB	_____	0.1 dB
-20 dB	-0.1 dB	_____	0.1 dB
-30 dB	-0.1 dB	_____	0.1 dB
-40 dB	-0.1 dB	_____	0.1 dB
-50 dB	-0.2 dB	_____	0.2 dB
-60 dB	-0.2 dB	_____	0.2 dB
-70 dB	-0.6 dB	_____	0.6 dB
-80 dB	-1.5 dB	_____	1.5 dB

(INPUT LEVEL is relative to the reference; -30 dBm.)

2-10. AMPLITUDE MEASUREMENT FREQUENCY RESPONSE TEST

INPUT PORT: R1

FREQUENCY	MINIMUM LIMIT	TEST RESULT	MAXIMUM LIMIT
10 Hz	-1.5 dB	_____	1.5 dB
100 kHz	-1.5 dB	_____	1.5 dB
9.99 MHz	-1.5 dB	_____	1.5 dB
10 MHz	-1.5 dB	_____	1.5 dB
149.99 MHz	-1.5 dB	_____	1.5 dB
150 MHz	-1.5 dB	_____	1.5 dB
224.99 MHz	-1.5 dB	_____	1.5 dB
225 MHz	-1.5 dB	_____	1.5 dB
339.99 MHz	-1.5 dB	_____	1.5 dB
340 MHz	-1.5 dB	_____	1.5 dB
500 MHz	-1.5 dB	_____	1.5 dB

INPUT PORT: T1

FREQUENCY	MINIMUM LIMIT	TEST RESULT	MAXIMUM LIMIT
10 Hz	-1.5 dB	_____	1.5 dB
100 kHz	-1.5 dB	_____	1.5 dB
10 MHz	-1.5 dB	_____	1.5 dB
150 MHz	-1.5 dB	_____	1.5 dB
225 MHz	-1.5 dB	_____	1.5 dB
340 MHz	-1.5 dB	_____	1.5 dB
500 MHz	-1.5 dB	_____	1.5 dB

PERFORMANCE TEST RECORD

INPUT PORT: R2

FREQUENCY	MINIMUM LIMIT	TEST RESULT	MAXIMUM LIMIT
10 Hz	-1.5 dB	_____	1.5 dB
100 kHz	-1.5 dB	_____	1.5 dB
10 MHz	-1.5 dB	_____	1.5 dB
150 MHz	-1.5 dB	_____	1.5 dB
225 MHz	-1.5 dB	_____	1.5 dB
340 MHz	-1.5 dB	_____	1.5 dB
500 MHz	-1.5 dB	_____	1.5 dB

INPUT PORT: T2

FREQUENCY	MINIMUM LIMIT	TEST RESULT	MAXIMUM LIMIT
10 Hz	-1.5 dB	_____	1.5 dB
100 kHz	-1.5 dB	_____	1.5 dB
10 MHz	-1.5 dB	_____	1.5 dB
150 MHz	-1.5 dB	_____	1.5 dB
225 MHz	-1.5 dB	_____	1.5 dB
340 MHz	-1.5 dB	_____	1.5 dB
500 MHz	-1.5 dB	_____	1.5 dB

PERFORMANCE TEST RECORD

2-11. SECOND HARMONIC DISTORTION TEST

TEST RESULT	TEST LIMIT
_____	≤ -70 dBc

2-12. THIRD ORDER INTERMODULATION DISTORTION TEST

SG1 OUTPUT FREQUENCY	INTERMODULATION FREQUENCY	TEST RESULT	TEST LIMIT
2.02 MHz	1.52 MHz	_____	≤ -80 dBc
	3.02 MHz	_____	≤ -80 dBc
5.02 MHz	4.52 MHz	_____	≤ -80 dBc
	6.02 MHz	_____	≤ -80 dBc
10.20 MHz	9.70 MHz	_____	≤ -80 dBc
	11.20 MHz	_____	≤ -80 dBc
20.20 MHz	19.70 MHz	_____	≤ -80 dBc
	21.20 MHz	_____	≤ -80 dBc
50.20 MHz	49.70 MHz	_____	≤ -80 dBc
	51.20 MHz	_____	≤ -80 dBc
100.20 MHz	99.70 MHz	_____	≤ -80 dBc
	101.20 MHz	_____	≤ -80 dBc
200.20 MHz	199.70 MHz	_____	≤ -80 dBc
	201.20 MHz	_____	≤ -80 dBc
490.20 MHz	489.70 MHz	_____	≤ -80 dBc

2-13. RESIDUAL RESPONSE TEST

CENTER FREQUENCY	TEST RESULT FREQUENCY	DATA	TEST LIMIT
2.000 000 MHz	at _____	_____	≤ -110 dBm
27.407 407 MHz	at _____	_____	≤ -110 dBm
105.714 285 MHz	at _____	_____	≤ -110 dBm
133.333 333 MHz	at _____	_____	≤ -110 dBm
150.000 000 MHz	at _____	_____	≤ -110 dBm
160.000 000 MHz	at _____	_____	≤ -110 dBm
235.555 555 MHz	at _____	_____	≤ -110 dBm
320.000 000 MHz	at _____	_____	≤ -110 dBm
333.333 333 MHz	at _____	_____	≤ -110 dBm
360.000 000 MHz	at _____	_____	≤ -110 dBm
375.555 555 MHz	at _____	_____	≤ -110 dBm
404.444 444 MHz	at _____	_____	≤ -110 dBm
480.000 000 MHz	at _____	_____	≤ -110 dBm

PERFORMANCE TEST RECORD

2-14. LEVEL ACCURACY/FLATNESS TEST

OUTPUT PORT: S1

LEVEL ACCURACY (at 50 MHz)

MINIMUM LIMIT	TEST RESULT	MAXIMUM LIMIT
9.5 dBm	_____	10.5 dBm

FLATNESS

FREQUENCY	MINIMUM LIMIT	TEST RESULT	MAXIMUM LIMIT
10 Hz	-1.5 dB	_____	1.5 dB
100 Hz	-1.5 dB	_____	1.5 dB
1 kHz	-1.5 dB	_____	1.5 dB
10 kHz	-1.5 dB	_____	1.5 dB
100 kHz	-1.5 dB	_____	1.5 dB
1 MHz	-1.5 dB	_____	1.5 dB
9.99 MHz	-1.5 dB	_____	1.5 dB
10 MHz	-1.5 dB	_____	1.5 dB
149.9 MHz	-1.5 dB	_____	1.5 dB
150 MHz	-1.5 dB	_____	1.5 dB
192 MHz	-1.5 dB	_____	1.5 dB
224.9 MHz	-1.5 dB	_____	1.5 dB
225 MHz	-1.5 dB	_____	1.5 dB
300 MHz	-1.5 dB	_____	1.5 dB
339.9 MHz	-1.5 dB	_____	1.5 dB
340 MHz	-1.5 dB	_____	1.5 dB
420 MHz	-1.5 dB	_____	1.5 dB
500 MHz	-1.5 dB	_____	1.5 dB

PERFORMANCE TEST RECORD

OUTPUT PORT: S2

LEVEL ACCURACY (at 50 MHz)

MINIMUM LIMIT	TEST RESULT	MAXIMUM LIMIT
9.5 dBm	_____	10.5 dBm

FLATNESS

FREQUENCY	MINIMUM LIMIT	TEST RESULT	MAXIMUM LIMIT
10 Hz	-1.5 dB	_____	1.5 dB
100 Hz	-1.5 dB	_____	1.5 dB
1 kHz	-1.5 dB	_____	1.5 dB
10 kHz	-1.5 dB	_____	1.5 dB
100 kHz	-1.5 dB	_____	1.5 dB
1 MHz	-1.5 dB	_____	1.5 dB
9.99 MHz	-1.5 dB	_____	1.5 dB
10 MHz	-1.5 dB	_____	1.5 dB
149.9 MHz	-1.5 dB	_____	1.5 dB
150 MHz	-1.5 dB	_____	1.5 dB
192 MHz	-1.5 dB	_____	1.5 dB
224.9 MHz	-1.5 dB	_____	1.5 dB
225 MHz	-1.5 dB	_____	1.5 dB
300 MHz	-1.5 dB	_____	1.5 dB
339.9 MHz	-1.5 dB	_____	1.5 dB
340 MHz	-1.5 dB	_____	1.5 dB
420 MHz	-1.5 dB	_____	1.5 dB
500 MHz	-1.5 dB	_____	1.5 dB

2-15. NON-SWEEP LINEARITY TEST

OUTPUT PORT: S1

OUTPUT LEVEL	MINIMUM LIMIT	TEST RESULT	MAXIMUM LIMIT
5 dBm	-0.5 dB	_____	0.5 dB
0 dBm	-0.5 dB	_____	0.5 dB
-5 dBm	-0.5 dB	_____	0.5 dB
-10 dBm	-0.5 dB	_____	0.5 dB
-15 dBm	-0.5 dB	_____	0.5 dB
-20 dBm	-0.5 dB	_____	0.5 dB
-25 dBm	-0.5 dB	_____	0.5 dB
-30 dBm	-0.5 dB	_____	0.5 dB
-35 dBm	-0.5 dB	_____	0.5 dB

OUTPUT PORT: S2

OUTPUT LEVEL	MINIMUM LIMIT	TEST RESULT	MAXIMUM LIMIT
5 dBm	-0.5 dB	_____	0.5 dB
0 dBm	-0.5 dB	_____	0.5 dB
-5 dBm	-0.5 dB	_____	0.5 dB
-10 dBm	-0.5 dB	_____	0.5 dB
-15 dBm	-0.5 dB	_____	0.5 dB
-20 dBm	-0.5 dB	_____	0.5 dB
-25 dBm	-0.5 dB	_____	0.5 dB
-30 dBm	-0.5 dB	_____	0.5 dB
-35 dBm	-0.5 dB	_____	0.5 dB

2-16. POWER SWEEP LINEARITY TEST

INPUT LEVEL	OUTPUT LEVEL	MINIMUM LIMIT	TEST RESULT	MAXIMUM LIMIT
-10 dBm	10 dBm	-0.2 dB/10 dB	_____	0.2 dB/10 dB
-15 dBm	5 dBm	-0.2 dB/10 dB	_____	0.2 dB/10 dB
-21 dBm	-1 dBm	-0.2 dB/10 dB	_____	0.2 dB/10 dB
	-21 dBm	-0.2 dB/10 dB	_____	0.2 dB/10 dB

PERFORMANCE TEST RECORD

2-17. SECOND HARMONICS TEST

OUTPUT PORT: S1

FREQUENCY	TEST RESULT	TEST LIMIT
5 MHz	_____	≤-30 dBc
150 MHz	_____	≤-30 dBc
225 MHz	_____	≤-30 dBc
340 MHz	_____	≤-30 dBc

OUTPUT PORT: S2

FREQUENCY	TEST RESULT	TEST LIMIT
5 MHz	_____	≤-30 dBc
150 MHz	_____	≤-30 dBc
225 MHz	_____	≤-30 dBc
340 MHz	_____	≤-30 dBc

2-18. NON-HARMONIC SPURIOUS TEST

OUTPUT PORT: S1

FREQUENCY	TEST RESULT	TEST LIMIT
123 MHz	_____	<-50 dBc
140 MHz	_____	<-50 dBc

OUTPUT PORT: S2

FREQUENCY	TEST RESULT	TEST LIMIT
123 MHz	_____	<-50 dBc
140 MHz	_____	<-50 dBc

PERFORMANCE TEST RECORD

2-19. PHASE NOISE TEST

reference	FREQUENCY	TEST RESULT	TEST LIMIT
320.1 MHz	320.08 MHz	_____	<-100 dBc/Hz
	320.12 MHz	_____	<-100 dBc/Hz
500 MHz	499.98 MHz	_____	<-100 dBc/Hz
	500.02 MHz	_____	<-100 dBc/Hz

Change the Test Limits to <-90 dBc/Hz, if the HP 4195A under test is serial number prefixed 2738J, and if the HP 4195A is NOT modified for high purity local oscillator.

PERFORMANCE TEST RECORD

2-20. CROSSTALK TEST

INPUT PORT: T1/R1

FREQUENCY RANGE	TEST RESULT	TEST LIMIT
100 Hz to 400 MHz	_____	<-100 dB
400 MHz to 500 MHz	_____	<-90 dB

INPUT PORT: R2/R1

FREQUENCY RANGE	TEST RESULT	TEST LIMIT
100 Hz to 400 MHz	_____	<-100 dB
400 MHz to 500 MHz	_____	<-90 dB

INPUT PORT: T2/R1

FREQUENCY RANGE	TEST RESULT	TEST LIMIT
100 Hz to 400 MHz	_____	<-100 dB
400 MHz to 500 MHz	_____	<-90 dB

INPUT PORT: T1/R2

FREQUENCY RANGE	TEST RESULT	TEST LIMIT
100 Hz to 400 MHz	_____	<-100 dB
400 MHz to 500 MHz	_____	<-90 dB

INPUT PORT: T2/R2

FREQUENCY RANGE	TEST RESULT	TEST LIMIT
100 Hz to 400 MHz	_____	<-100 dB
400 MHz to 500 MHz	_____	<-90 dB

PERFORMANCE TEST RECORD

2-21. MAGNITUDE RATIO/PHASE DYNAMIC ACCURACY TEST

INPUT PORT: T1/R1, OUTPUT PORT: S1

	INPUT LEVEL	MINIMUM LIMIT	TEST RESULT	MAXIMUM LIMIT
PHASE:	-10 dBm	-2.00 deg	_____	2.00 deg
	-20 dBm	-0.78 deg	_____	0.78 deg
	-40 dBm	-0.30 deg	_____	0.30 deg
	-50 dBm	-0.30 deg	_____	0.30 deg
	-60 dBm	-0.30 deg	_____	0.30 deg
	-70 dBm	-0.30 deg	_____	0.30 deg
	-80 dBm	-0.95 deg	_____	0.95 deg
	-90 dBm	-3.00 deg	_____	3.00 deg
	-100 dBm	-9.49 deg	_____	9.49 deg
	-110 dBm	-30.00 deg	_____	30.00 deg
	MAGNITUDE RATIO:	-10 dBm	-0.350 dB	_____
-20 dBm		-0.132 dB	_____	0.132 dB
-40 dBm		-0.050 dB	_____	0.050 dB
-50 dBm		-0.050 dB	_____	0.050 dB
-60 dBm		-0.050 dB	_____	0.050 dB
-70 dBm		-0.050 dB	_____	0.050 dB
-80 dBm		-0.139 dB	_____	0.139 dB
-90 dBm		-0.387 dB	_____	0.387 dB
-100 dBm		-1.078 dB	_____	1.078 dB
-110 dBm		-3.000 dB	_____	3.000 dB

INPUT PORT: R2/R1, OUTPUT PORT: S1

	INPUT LEVEL	MINIMUM LIMIT	TEST RESULT	MAXIMUM LIMIT
PHASE:	-10 dBm	-2.00 deg	_____	2.00 deg
	-20 dBm	-0.78 deg	_____	0.78 deg
	-40 dBm	-0.30 deg	_____	0.30 deg
	-50 dBm	-0.30 deg	_____	0.30 deg
	-60 dBm	-0.30 deg	_____	0.30 deg
	-70 dBm	-0.30 deg	_____	0.30 deg
	-80 dBm	-0.95 deg	_____	0.95 deg
	-90 dBm	-3.00 deg	_____	3.00 deg
	-100 dBm	-9.49 deg	_____	9.49 deg
	-110 dBm	-30.00 deg	_____	30.00 deg
	MAGNITUDE RATIO:	-10 dBm	-0.350 dB	_____
-20 dBm		-0.132 dB	_____	0.132 dB
-40 dBm		-0.050 dB	_____	0.050 dB
-50 dBm		-0.050 dB	_____	0.050 dB
-60 dBm		-0.050 dB	_____	0.050 dB
-70 dBm		-0.050 dB	_____	0.050 dB
-80 dBm		-0.139 dB	_____	0.139 dB
-90 dBm		-0.387 dB	_____	0.387 dB
-100 dBm		-1.078 dB	_____	1.078 dB
-110 dBm		-3.000 dB	_____	3.000 dB

PERFORMANCE TEST RECORD

INPUT PORT: T2/R2, OUTPUT PORT: S2

	INPUT LEVEL	MINIMUM LIMIT	TEST RESULT	MAXIMUM LIMIT
PHASE:				
	-10 dBm	-2.00 deg	_____	2.00 deg
	-20 dBm	-0.78 deg	_____	0.78 deg
	-40 dBm	-0.30 deg	_____	0.30 deg
	-50 dBm	-0.30 deg	_____	0.30 deg
	-60 dBm	-0.30 deg	_____	0.30 deg
	-70 dBm	-0.30 deg	_____	0.30 deg
	-80 dBm	-0.95 deg	_____	0.95 deg
	-90 dBm	-3.00 deg	_____	3.00 deg
	-100 dBm	-9.49 deg	_____	9.49 deg
	-110 dBm	-30.00 deg	_____	30.00 deg
MAGNITUDE RATIO:				
	-10 dBm	-0.350 dB	_____	0.350 dB
	-20 dBm	-0.132 dB	_____	0.132 dB
	-40 dBm	-0.050 dB	_____	0.050 dB
	-50 dBm	-0.050 dB	_____	0.050 dB
	-60 dBm	-0.050 dB	_____	0.050 dB
	-70 dBm	-0.050 dB	_____	0.050 dB
	-80 dBm	-0.139 dB	_____	0.139 dB
	-90 dBm	-0.387 dB	_____	0.387 dB
	-100 dBm	-1.078 dB	_____	1.078 dB
	-110 dBm	-3.000 dB	_____	3.000 dB

PERFORMANCE TEST RECORD

2-22. MAGNITUDE RATIO/PHASE FREQUENCY RESPONSE TEST

INPUT PORT: T1/R1

FREQUENCY RANGE	MINIMUM LIMIT	TEST RESULT	MAXIMUM LIMIT
<u>INPUT ATTENUATOR: 0 dB</u>			
MAGNITUDE RATIO:			
F ≤ 200 MHz	-1.0 dB	_____	1.0 dB
F > 200 MHz	-1.5 dB	_____	1.5 dB
PHASE:			
F ≤ 200 MHz	-5.0 deg	_____	5.0 deg
F > 200 MHz	-7.5 deg	_____	7.5 deg
<u>INPUT ATTENUATOR: 10 dB</u>			
MAGNITUDE RATIO:			
F ≤ 200 MHz	-1.0 dB	_____	1.0 dB
F > 200 MHz	-1.5 dB	_____	1.5 dB
PHASE:			
F ≤ 200 MHz	-5.0 deg	_____	5.0 deg
F > 200 MHz	-7.5 deg	_____	7.5 deg
<u>INPUT ATTENUATOR: 20 dB</u>			
MAGNITUDE RATIO:			
F ≤ 200 MHz	-1.0 dB	_____	1.0 dB
F > 200 MHz	-1.5 dB	_____	1.5 dB
PHASE:			
F ≤ 200 MHz	-5.0 deg	_____	5.0 deg
F > 200 MHz	-7.5 deg	_____	7.5 deg
<u>INPUT ATTENUATOR: 40 dB</u>			
MAGNITUDE RATIO:			
F ≤ 200 MHz	-1.0 dB	_____	1.0 dB
F > 200 MHz	-1.5 dB	_____	1.5 dB
PHASE:			
F ≤ 200 MHz	-5.0 deg	_____	5.0 deg
F > 200 MHz	-7.5 deg	_____	7.5 deg

PERFORMANCE TEST RECORD

INPUT PORT: R2/R1

FREQUENCY RANGE	MINIMUM LIMIT	TEST RESULT	MAXIMUM LIMIT
<u>INPUT ATTENUATOR: 0 dB</u>			
MAGNITUDE RATIO:			
F ≤ 200 MHz	-1.0 dB	_____	1.0 dB
F > 200 MHz	-1.5 dB	_____	1.5 dB
PHASE:			
F ≤ 200 MHz	-5.0 deg	_____	5.0 deg
F > 200 MHz	-7.5 deg	_____	7.5 deg
<u>INPUT ATTENUATOR: 10 dB</u>			
MAGNITUDE RATIO:			
F ≤ 200 MHz	-1.0 dB	_____	1.0 dB
F > 200 MHz	-1.5 dB	_____	1.5 dB
PHASE:			
F ≤ 200 MHz	-5.0 deg	_____	5.0 deg
F > 200 MHz	-7.5 deg	_____	7.5 deg
<u>INPUT ATTENUATOR: 20 dB</u>			
MAGNITUDE RATIO:			
F ≤ 200 MHz	-1.0 dB	_____	1.0 dB
F > 200 MHz	-1.5 dB	_____	1.5 dB
PHASE:			
F ≤ 200 MHz	-5.0 deg	_____	5.0 deg
F > 200 MHz	-7.5 deg	_____	7.5 deg
<u>INPUT ATTENUATOR: 40 dB</u>			
MAGNITUDE RATIO:			
F ≤ 200 MHz	-1.0 dB	_____	1.0 dB
F > 200 MHz	-1.5 dB	_____	1.5 dB
PHASE:			
F ≤ 200 MHz	-5.0 deg	_____	5.0 deg
F > 200 MHz	-7.5 deg	_____	7.5 deg

PERFORMANCE TEST RECORD

INPUT PORT: T2/R2

FREQUENCY RANGE	MINIMUM LIMIT	TEST RESULT	MAXIMUM LIMIT
<u>INPUT ATTENUATOR: 0 dB</u>			
MAGNITUDE RATIO:			
F ≤ 200 MHz	-1.0 dB	_____	1.0 dB
F > 200 MHz	-1.5 dB	_____	1.5 dB
PHASE:			
F ≤ 200 MHz	-5.0 deg	_____	5.0 deg
F > 200 MHz	-7.5 deg	_____	7.5 deg
<u>INPUT ATTENUATOR: 10 dB</u>			
MAGNITUDE RATIO:			
F ≤ 200 MHz	-1.0 dB	_____	1.0 dB
F > 200 MHz	-1.5 dB	_____	1.5 dB
PHASE:			
F ≤ 200 MHz	-5.0 deg	_____	5.0 deg
F > 200 MHz	-7.5 deg	_____	7.5 deg
<u>INPUT ATTENUATOR: 20 dB</u>			
MAGNITUDE RATIO:			
F ≤ 200 MHz	-1.0 dB	_____	1.0 dB
F > 200 MHz	-1.5 dB	_____	1.5 dB
PHASE:			
F ≤ 200 MHz	-5.0 deg	_____	5.0 deg
F > 200 MHz	-7.5 deg	_____	7.5 deg
<u>INPUT ATTENUATOR: 40 dB</u>			
MAGNITUDE RATIO:			
F ≤ 200 MHz	-1.0 dB	_____	1.0 dB
F > 200 MHz	-1.5 dB	_____	1.5 dB
PHASE:			
F ≤ 200 MHz	-5.0 deg	_____	5.0 deg
F > 200 MHz	-7.5 deg	_____	7.5 deg

PERFORMANCE TEST RECORD

2-23. DC SOURCE VOLTAGE ACCURACY TEST

DC BIAS LEVEL	MINIMUM LIMIT	TEST RESULT	MAXIMUM LIMIT
-40 V	-40.053 V	_____	-39.947 V
-30 V	-30.041 V	_____	-29.959 V
-20 V	-20.029 V	_____	-19.971 V
-10 V	-10.017 V	_____	-9.983 V
0 V	-0.005 V	_____	0.005 V
10 V	9.983 V	_____	10.017 V
20 V	19.971 V	_____	20.029 V
30 V	29.959 V	_____	30.041 V
40 V	39.947 V	_____	40.053 V

SECTION 3

ADJUSTMENTS

3-1. INTRODUCTION

This section describes the adjustments required to return the HP 4195A to a condition to meet the specifications listed in the Operation Manual if the HP 4195A failed the Performance Test, or after it has been repaired. These adjustments can be also performed along with periodic maintenance to keep the instrument in optimum operating condition. The recommended adjustment cycle for the HP 4195A is twice a year. If proper performance cannot be achieved after adjustment, refer to the troubleshooting procedures described in the HP 4195A Service Manual.

NOTE

The HP 4195A Service Manual is not furnished with the instrument. To obtain the Service Manual, contact to your nearest HP Sales Office.

3-2. SAFETY CONSIDERATIONS

This manual contains **WARNINGS**, **CAUTIONS**, and **NOTES** which must be followed to ensure the safety of operator and to keep the instrument in a safe and serviceable condition. The adjustments covered in this section should be performed by qualified service personnel only.

WARNING

ANY INTERRUPTION OF THE PROTECTIVE (GROUND) CONDUCTOR (INSIDE OR OUTSIDE THE INSTRUMENT) OR DISCONNECTION OF THE PROTECTIVE EARTH TERMINAL IS LIKELY TO MAKE THE INSTRUMENT DANGEROUS. INTENTIONAL INTERRUPTION, FOR ANY REASON, IS PROHIBITED.

The removal or opening of covers for removal or adjustment of parts, other than those which are accessible by hand, will expose live circuits.

Remember that even though you may have shut the instrument off and unplugged it, the capacitors in the HP 4195A will remain charged for quite a while.

WARNING

THE ADJUSTMENTS DESCRIBED IN THIS SECTION ARE PERFORMED WITH POWER APPLIED AND THE PROTECTIVE COVERS REMOVED. ENERGY EXISTING AT MANY POINTS MAY, IF CONTACTED, RESULT IN SERIOUS PERSONAL INJURY.

WARNING

TO PROTECT AGAINST POSSIBLE ELECTRICAL SHOCK HAZARDS, USE INSULATED TOOLS FOR ALL ADJUSTMENTS.

3-3. ADJUSTABLE AND FACTORY SELECTED COMPONENTS

Table 3-1 lists the HP 4195A adjustable components, gives the name of the adjustment related to each component, and provides a brief description of each adjustment.

Several components are factory selected. Table 3-2 lists these selected components, gives their nominal values, and provides reference information concerning the effect each component has on the HP 4195A's performance.

NOTE

On the schematic diagrams of Service Manual, factory selected components are identified by an asterisk (*) next to the component's reference designator. Only the nominal values are given for these components.

3-4. ADJUSTMENT INTERACTIONS

A number of the adjustments are interactive. If you repair or replace an HP 4195A assembly, be sure to perform the related adjustment(s) in the sequence given. Table 3-3 lists the adjustments required for each assembly repaired or replaced. Ignoring or changing the order of the adjustments will make it impossible to obtain optimum performance.

3-5. ADJUSTMENT LOCATIONS

The Adjustment Component Locations and Board Locations required to locate the adjustment points are included in each adjustment procedure. Appendix B and C in this manual shows the Board Assembly List, and the Board Assembly Locations, respectively.

3-6. PREPARATION FOR ADJUSTMENT

This paragraph describes the information you should know before adjusting the HP 4195A.

3-6-1. CONSTRUCTION OF ADJUSTMENT INSTRUCTION

The adjustment instructions in this section consist of three parts; **EQUIPMENT**, **SUMMARY** and **PROCEDURE**. **EQUIPMENT** lists the equipment required to perform the adjustment. **SUMMARY** gives a summary of the adjustment procedure; the monitor or monitoring point for the adjustment (**MONITOR**), the components to be adjusted (**ADJUSTMENT COMPONENT**), and target values for the adjustment (**TARGET**). The **PROCEDURE** describes the adjustment procedure.

3-6-2. SERVICE FUNCTION

The HP 4195A provides Service Functions to simplify some of the adjustment procedures. The Service Functions are the HP 4195A's hidden function which sets up the conditions for adjustments, or monitors adjustment parameters. Several Service Functions are included. They are listed to the Service Function menu, which is displayed on the HP 4195A's display by entering the "STSET" command. How to use the Service Functions is described in each adjustment procedure.

3-6-3. EXTERNAL REFERENCE

The HP 4195A's rear panel **EXT REFERENCE** connector is used to synchronize the HP 4195A with other test equipment; Signal Generator, Spectrum Analyzer, etc. If the HP 4195A is equipped with Option 001, disconnect the BNC cable connecting the **EXT REFERENCE** to the **REFERENCE OVEN**.

3-7. SPECIAL DEVICE FOR ADJUSTMENT

The Required Equipment List (Table 1-1) lists a special device that you must construct, a 464 Ω resistor has a BNC(f) connector soldered to each of its leads, as shown in Figure 3-1. Make this special device to perform the adjustments listed below.

- 3-18-2. THIRD IF CONVERTER 6.3/6.9 MHz BPF ADJUSTMENTS
 3-18-4. THIRD IF CONVERTER 6.6MHz LEVEL ADJUSTMENT

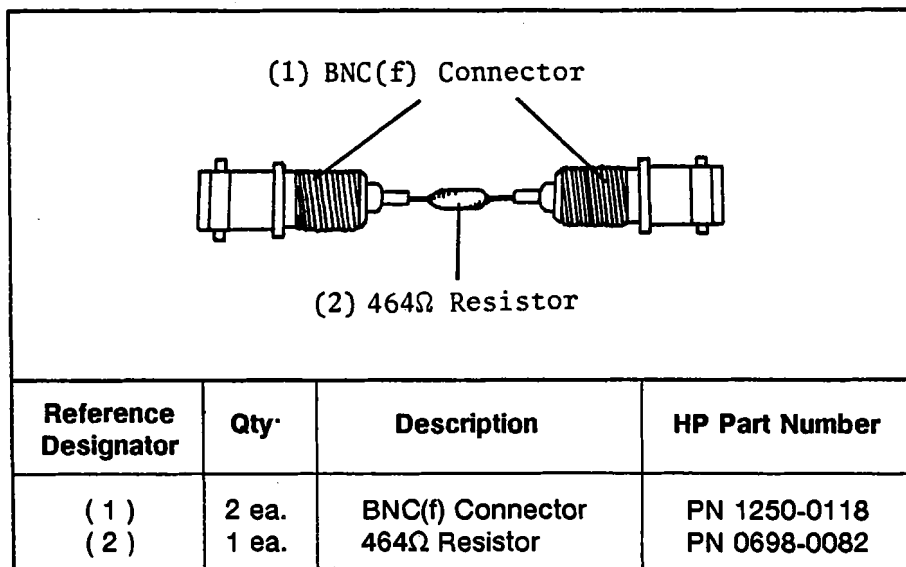

Figure 3-1. Special Device (464 Ω Resistor)

Table 3-1. Adjustable Components (sheet 1 of 5)

Adjustable Component	Adjustment Name	Description
A2R7	V-ADJ	Adjusts the switching power supply output voltage
A2R8	FRQ-ADJ	Adjusts the power supply switching frequency
A4L1	H SIZE	Adjusts the display horizontal size
A4R45	PIN	Minimizes the display pincushion distortion
A4R46	V SIZE	Adjusts the display vertical size
A4R47	V HOLD	Adjusts the display vertical hold
A4R48	H HOLD	Adjusts the display horizontal hold
A4R49	V POS	Adjusts the display vertical position
A4R67	VOLT ADJ	Adjusts the display section local voltage
A4T3	FOCUS	Adjusts the display focus
A4T3	SCREEN	Adjusts the CRT screen voltage
A4W1 A4W2		Selects the display horizontal position
A5R4 A5R11	B CUTOFF G CUTOFF	Adjusts the CRT cutoff voltage
A5R30 A5R31 A5R32 A5R33	BH BL GH GL	Adjusts the display tint
A5R34	MAX INTEN	Adjusts the maximum intensity
INTENSITY	INTENSITY	Adjusts the display intensity
A8U17	EEPROM	Updates system calibration constants
A9R58	GAIN ADJ	Tracks the gain of the 0° and 90° phase detectors
A9R75	PHASE ADJ	Tracks the phase shift of the 0° and 90° phase detectors

Table 3-1. Adjustable Components (sheet 2 of 5)

Adjustable Component	Adjustment Name	Description
A10A1R5	API4 ADJ	Reduces phase noise
A10A1R14	API2 ADJ	Reduces phase noise
A10A1R15	API3 ADJ	Reduces phase noise
A10A1R28	API1 ADJ	Reduces phase noise
A10A4R11	REF FREQ ADJ	Adjusts the 80 MHz VCXO free-running frequency
A10A6R12	100kHz NULL ADJ	Reduces 100 kHz sideband noise
A10C1	REF LEVEL ADJ	Adjusts the 80 MHz crystal oscillator's output signal amplitude
A10L204	160MHz NULL ADJ	Reduces the 160MHz component from VCO output (for A10 board with PN 04195-66510 only)
A17R1	CONVERGENCE	Adjusts the display convergence
A20C16	6.9MHz BPF ADJ	Adjusts the high frequency cutoff point of the 6.6 MHz bandpass filter
A20C18	20dB AMPL PHASE ADJ	Adjusts the 20 dB IF amplifier phase shift
A20C26	6.3MHz BPF ADJ	Adjusts the low frequency cutoff point of the 6.6 MHz bandpass filter
A20L20 A20L21 A20L22	86.6MHz BPF ADJ	Adjusts the 86.66 MHz bandpass filter center frequency and minimizes the passband ripple
A20R12	6.6MHz LEVEL ADJ	Adjusts the IF signal level
A20R19	20dB AMPL GAIN ADJ	Adjust the 20 dB IF amplifier gain
A20R31	10dB AMPL GAIN ADJ	Adjusts the 10 dB IF amplifier gain
A20R38	FLATNESS ADJ	Improves the passband flatness of the 6.6 MHz bandpass filter
A21L4 A21L7 A21L8	86.6MHz BPF ADJ	Adjusts the 86.66 MHz bandpass filter center frequency and minimizes its passband ripple

Table 3-1. Adjustable Components (sheet 3 of 5)

Adjustable Component	Adjustment Name	Description
A21L9 A21L10 A21L11	246MHz BPF ADJ	Adjusts the 246 MHz bandpass filter center frequency and minimizes its passband ripple
A21R9	86.6MHz LEVEL ADJ	Adjusts the 86.66 MHz output level
A22C52	LOCAL LEAK ADJ1	Reduces local feedthrough
A22R59	LOCAL LEAK ADJ2	Reduces local feedthrough
A22L2 A22L6 A22L7 A22L9	86.6MHz BPF ADJ	Adjusts the 86.66 MHz bandpass filter center frequency and minimizes its passband ripple
A22L3 A22L5 A22L8 A22L10	246MHz BPF ADJ	Adjusts the 86.66 MHz bandpass filter center frequency and minimizes its passband ripple
A22R47	86.6MHz LEVEL ADJ	Adjust 86.6 MHz IF gain
A22R52	246MHz LEVEL ADJ	Adjust 246 MHz IF gain
A23L3 A23L5 A23L7 A23L11	225MHz-340MHz BPF ADJ	Adjusts the 225 MHz-340 MHz voltage tunable filter characteristics
A23L15 A23L16 A23L17 A23L18	340MHz-500MHz BPF ADJ	Adjusts the 340 MHz - 500 MHz voltage tunable filter characteristics
A23L20 A23L21 A23L22 A23L23	150MHz-225MHz BPF ADJ	Adjusts the 150 MHz - 225 MHz voltage tunable filter characteristics
A24R48	OVERLOAD ADJ1	Adjusts the overload detection threshold level for network measurements
A24R49	OVERLOAD ADJ2	Adjusts the overload detection threshold level for spectrum measurements

Table 3-1. Adjustable Components (sheet 4 of 5)

Adjustable Component	Adjustment Name	Description
A26R66		Adjusts the overload detection threshold level for spectrum measurements
A26R78		Adjusts the overload detection threshold level for network measurements
A130L6 A130L7	160MHz BPF ADJ	Tunes the 160 MHz bandpass filter
A130R1	80MHz LEVEL ADJ	Adjusts the 80 MHz local signal level
A130R2	160MHz LEVEL ADJ	Adjusts the 160 MHz local signal level
A130R53	6.6MHz LEVEL ADJ	Adjusts signal source output amplitude
A40L1 A40L2	86.6MHz BPF1 ADJ	Adjusts the one 86.6 MHz band pass filter characteristics
A40L3 A40L4 A40L9	86.6MHz BPF2 ADJ	Adjusts the two 86.6 MHz band pass filter characteristics
A40L10 A40L16	86.6MHz BPF3 ADJ	Adjusts the three 86.6 MHz band pass filter characteristics
A40L5 A40L11 A40L17	246MHz BPF ADJ	Adjusts the 246 MHz bandpass filter characteristics
A40R14	2ND IF GAIN ADJ	Adjusts the 246 MHz IF level
A43L2	246MHz BPF ADJ	Not adjustable. If core is present remove it and throw away
A43L4 A43L5	86.6MHz BPF ADJ	Adjusts the 86.6 MHz bandpass filter characteristics
A43R44	10Hz-10MHz GAIN ADJ	Adjusts LF amplifier flatness in the frequency range below 10 MHz
A44L1 A44L2 A44L3 A44L4	150MHz-225MHz BPF ADJ	Adjusts the 150 MHz - 225 MHz voltage tunable filter characteristics
A44L6 A44L7 A44L8 A44L9	340MHz-500MHz BPF ADJ	Adjusts the 340 MHz - 500 MHz voltage tunable filter characteristics

Table 3-1. Adjustable Components (sheet 5 of 5)

Adjustable Component	Adjustment Name	Description
A44L15 A44L16 A44L17 A44L18	225MHz-340MHz BPF ADJ	Adjusts the 225 MHz - 340 MHz voltage tunable filter characteristics
A45R36		Reduces the S2 output transient dc offset
A45R39		Tracks the LF amplifier gain to HF amplifier
A46R36		Reduces the S2 output transient dc offset
A46R39		Tracks the LF amplifier gain to The HP amplifier
A51R11		Adjusts negative DC source full-scale
A51R18		Adjusts positive DC source full-scale
A60R1	F-ADJ	Adjusts the frequency of the crystal oven oscillator
A60R2	V-ADJ	Adjusts the supply voltage for the crystal oven oscillator

Table 3-2. Factory Selected Components

Component	Nominal Value Range	Reference
A5R7	6.19k Ω (PN 0757-0290) ▶ 12.1k Ω (PN 0757-0444) 19.6k Ω (PN 0698-3157)	Refer to paragraph 3-10-6.

▶: Component normally used.

Table 3-3. Required Adjustments

Assembly Required or Replaced	Required Adjustments (paragraph)
A1 Primary Rectifier	None
A2 Power Supply Control	3-8
A3 Power Supply Output	None
A4 CRT Deflection Amplifier	3-10
A5 Video Amplifier	3-10
A6 Signal Processor	None
A7 Graphic Display Controller/Shared RAM	None
A8 Measurement Control Processor	3-25
A9 Phase Detector/A-D Converter	3-24, 3-25
A10 Frequency Generator	3-11, 3-12, 3-13, 3-19, 3-20, 3-25
A12 Control Unit Keyboard Control	None
A13 Control Unit Keyboard	None
A14 Power Supply Motherboard	None
A15 Motherboard	None
A16 Flexible Disk Drive Controller	None
A17 CRT Socket	3-10
A20 Receiver 3rd IF Converter	3-18, 3-25
A21 Receiver 2nd IF Converter	3-17, 3-25
A128 Receiver 1st IF Lowpass Filter	3-25
A22 Receiver 1st IF Converter	3-16, 3-25
A23 Receiver Input Filter	3-15, 3-25
A24 High Frequency Multiplexer Buffer	3-14, 3-25
A25 High Frequency Multiplexer	3-14, 3-25
A26 Low Frequency Multiplexer	3-25
A27 R2 Input Attenuator	3-25
A28 T2 Input Attenuator	3-25
A29 R1 Input Attenuator	3-25
A30 T1 Input Attenuator	3-25
A130 Reference Frequency Converter	3-13, 3-25
A31 3rd IF Local Driver Amplifier	3-25
A32 2nd IF Local Driver Amplifier	3-25
A33 1st IF Local Driver Preamplifier	3-25
A34 1st IF Local Driver Amplifier	3-25
A40 Source 2nd/3rd IF Converter	3-19, 3-25
A43 Source 1st IF Converter	3-20, 3-25
A44 Source Output Filter	3-21, 3-25
A45 S2 Power Amplifier	3-22, 3-25
A46 S1 Power Amplifier	3-22, 3-25
A47 S2 Output Attenuator	3-25
A48 S1 Output Attenuator	3-25
A50 Receiver Circuit Control	3-15, 3-25
A51 Source Circuit Control	3-21, 3-23, 3-25
A52 Measurement Unit Keyboard	None
A60 High Stability Oscillator	3-9

3-8. SWITCHING POWER SUPPLY ADJUSTMENTS

3-8-1. SWITCHING FREQUENCY ADJUSTMENT

This procedure adjusts the switching power supply frequency.

EQUIPMENT:

Frequency Counter	HP 5385A
10:1 Divider Probe, 1 M Ω	HP 10040A

SUMMARY:

MONITOR:	Probe Tip:	Cathode of A3CR8
	Ground Lead:	A3TP3
ADJUSTMENT COMPONENT:		A2R8 (FRQ-ADJ)
TARGET:		Output Frequency: 58 kHz \pm 2 kHz

PROCEDURE:

1. Remove the HP 4195A Control Unit top shield plate.

WARNING

DANGEROUS VOLTAGES ARE PRESENT ON THE A1 BOARD. DON'T TOUCH ANY PLACE EXCEPT WHERE INSTRUCTED TO.

2. Connect the 10:1 Probe to the Counter A INPUT.

CAUTION

Don't ground the shielding or test pin on the A2 board.

3. Connect the Probe ground lead to A3TP3, and the probe tip to the A3CR8 cathode as shown in Figure 3-2 and Figure 3-3.

CAUTION

Use a 10:1 probe to monitor the frequency, since high voltage is present at the A3CR8's cathode.

ADJUSTMENTS

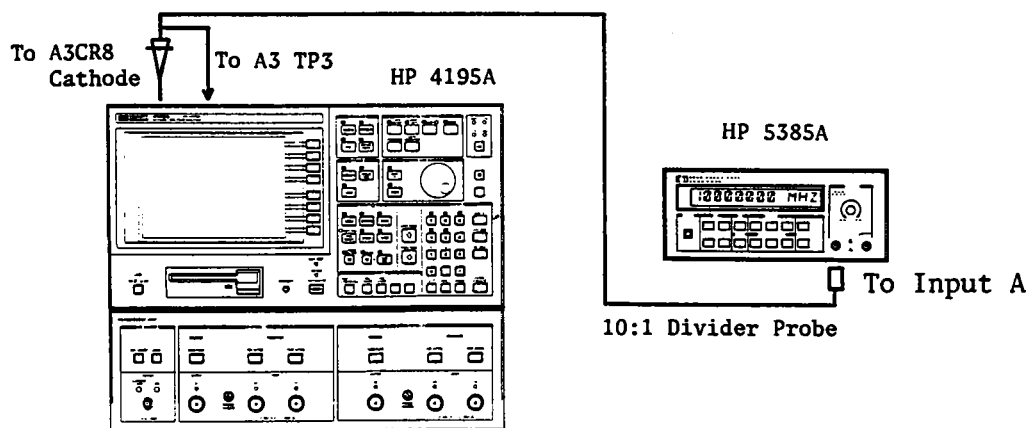

Figure 3-2. Switching Frequency Adjustment Setup

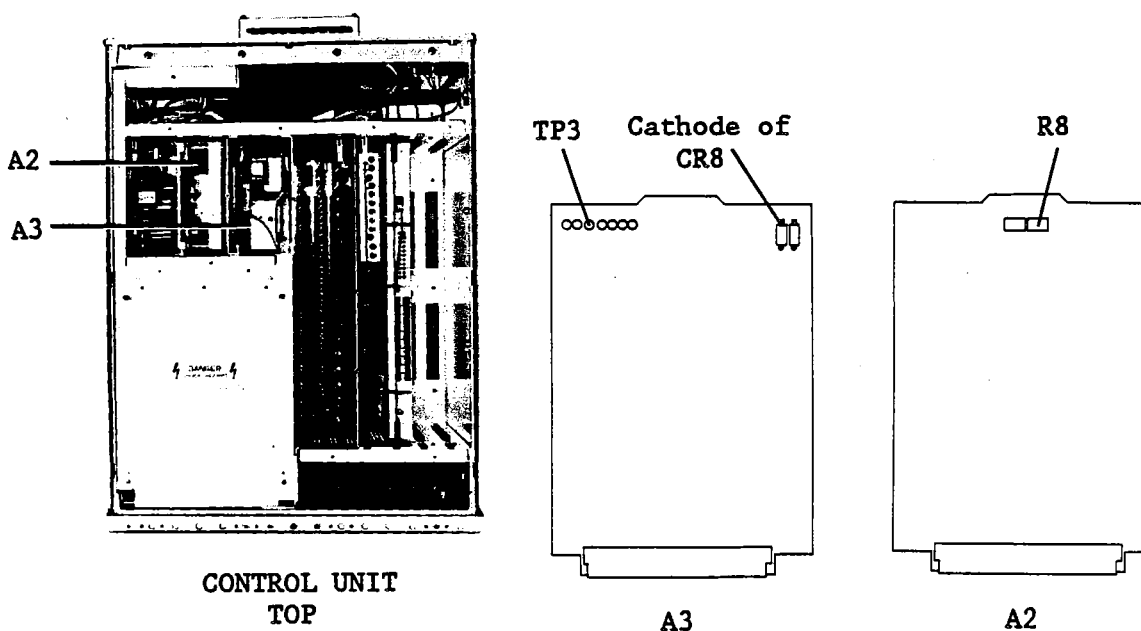

Figure 3-3. Switching Frequency Adjustment Locations

4. Turn the HP 4195A on.
5. Adjust A2R8 (FRQ-ADJ) until the Counter reads 58 kHz \pm 2 kHz.

NOTE

The being measured signal is distorted, so if the counter reads out a much different value from the target value, use the filter function or adjust the sensitivity to let the counter read the proper frequency.

6. Turn the HP 4195A off.
7. Disconnect the Probe from the cathode of A3CR8 and A3TP3.

ADJUSTMENTS

3-8-2. OUTPUT VOLTAGE ADJUSTMENT

This procedure adjusts the switching power supply output voltage.

EQUIPMENT:

Digital Voltmeter	HP 3456A
Dual Banana Plug to Alligator Clip Lead	HP 11002A

SUMMARY:

MONITOR:	High Lead:	A7TP2
	Low Lead:	A7TP1
ADJUSTMENT COMPONENT:		A2R7 (V-ADJ)
TARGET:	Output Voltage:	5.025 V \pm 0.010 V

PROCEDURE:

WARNING

DANGEROUS VOLTAGES ARE PRESENT ON THE A2 BOARD. DON'T TOUCH ANY PLACE EXCEPT WHERE INSTRUCTED TO.

1. Connect the Voltmeter low lead to A7TP1, and high lead to A7TP2 as shown in Figures 3-4 and 3-5.

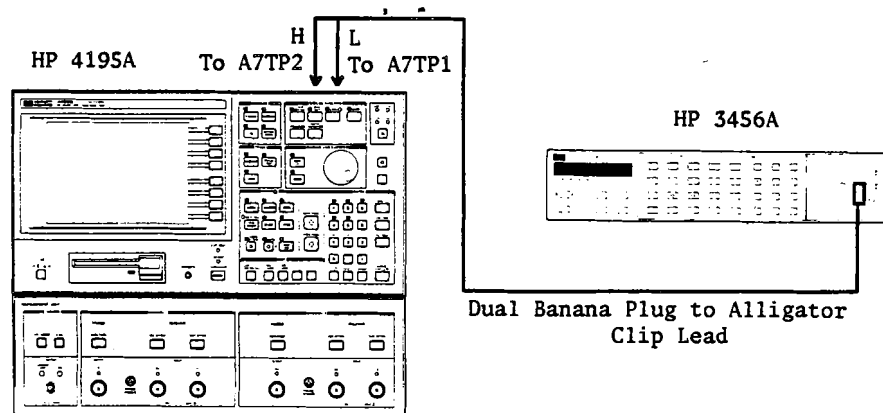

Figure 3-4. Output Voltage Adjustment Setup

ADJUSTMENTS

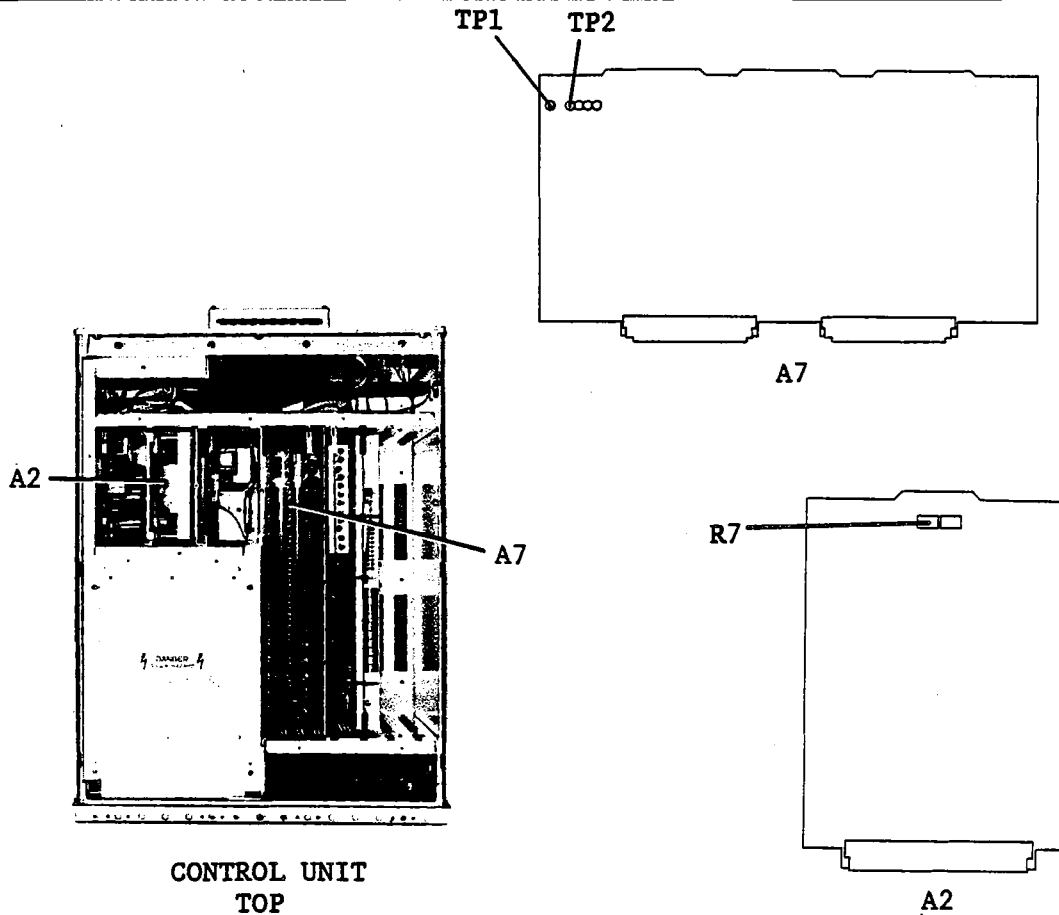

Figure 3-5. Output Voltage Adjustment Locations

2. Turn the HP 4195A on.
3. Adjust A2R7 (V-ADJ) until the Voltmeter reads $5.025\text{ V} \pm 0.010\text{ V}$.
4. Turn the HP 4195A off.
5. Disconnect the Voltmeter leads from A7TP2 and A7TP1.

3-9. HIGH STABILITY OSCILLATOR ADJUSTMENTS (OPT 001 ONLY)

3-9-1. SUPPLY VOLTAGE ADJUSTMENT

This procedure adjusts the supply voltage for the high stability oscillator.

EQUIPMENT:

Digital Voltmeter	HP 3456A
Dual Banana Plug to Alligator Clip Lead	HP 11002A

SUMMARY:

MONITOR:	High Lead:	A60TP1
	Low Lead:	A60TP3
ADJUSTMENT COMPONENT:		A60R2 (V-ADJ)
TARGET:	Output Voltage:	15.000 V \pm 0.015 V

PROCEDURE:

1. Position the HP 4195A on its left side with the cables connected as shown in Figure 3-6.

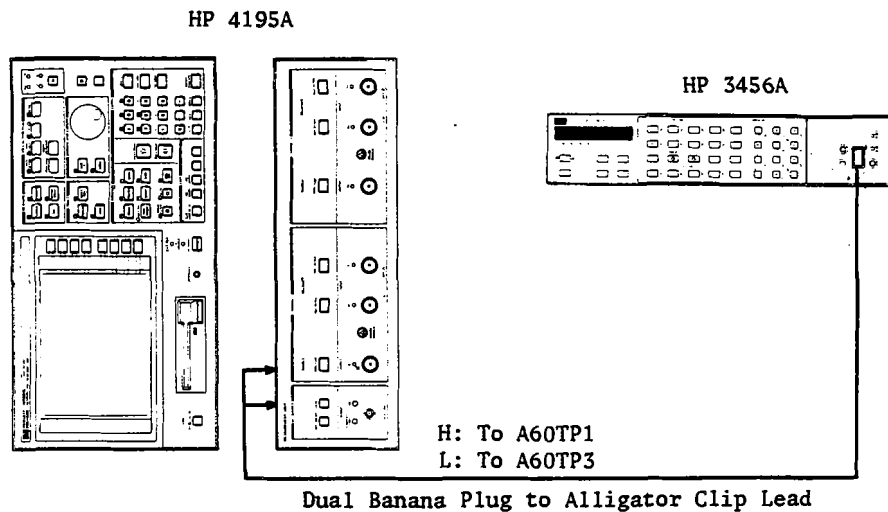

Figure 3-6. Supply Voltage Adjustment Setup

2. Connect the Voltmeter low lead to A60TP3, and the high lead to A60TP1. See Figure 3-7 for the TP locations.

ADJUSTMENTS

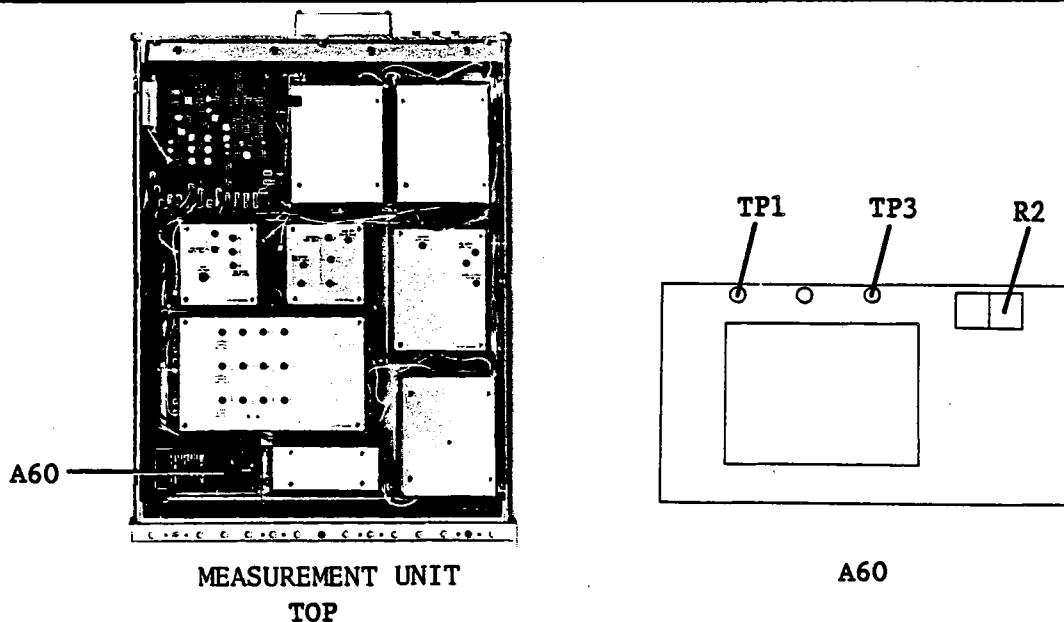

Figure 3-7. Supply Voltage Adjustment Locations

3. Turn the HP 4195A on.
4. Adjust A60R2 (V-ADJ) until the Voltmeter reads $15.000\text{ V} \pm 0.015\text{ V}$.

NOTE

If you are unable to adjust the voltage as specified, adjust the Power Supply as described in the section 3-8.

3-9-2. HIGH STABILITY OSCILLATOR FREQUENCY ADJUSTMENT

This procedure adjusts the high stability oscillator frequency.

EQUIPMENT:

Frequency Counter
BNC(m)-BNC(m) Cable, 50Ω , 61 cm

HP 5385A Opt.004
PN 8120-1839

SUMMARY:

MONITOR: REFERENCE OVEN on Measurement Unit rear panel.

ADJUSTMENT COMPONENT: A60R1 (F-ADJ)

TARGET: Output Frequency: $10\text{ MHz} \pm 1\text{ Hz}$

PROCEDURE:

1. If you are performing this procedure just after performing the procedure in paragraph 3-9-1, allow the HP 4195A to warm up for at least 30 minutes so that the crystal oven temperature to stabilize.

ADJUSTMENTS

2. Connect the equipment as shown in Figure 3-8.

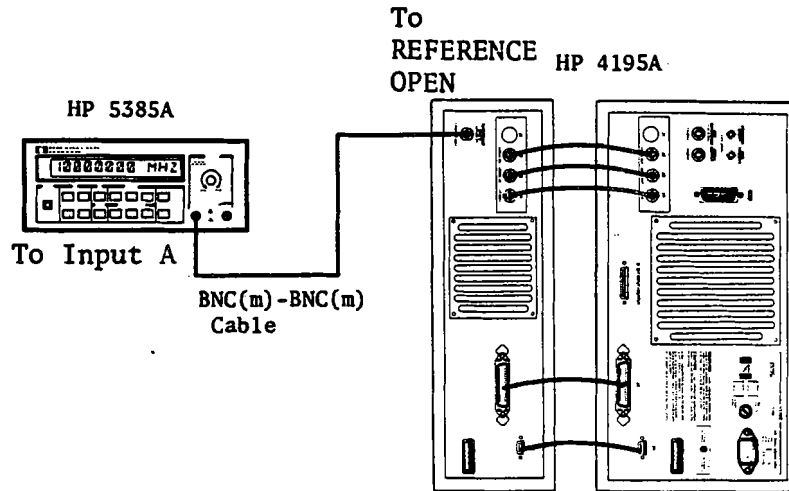

Figure 3-8. High Stability Oscillator Frequency Adjustment Setup

3. Adjust A60R1 (F-ADJ) until the Frequency Counter reads $10 \text{ MHz} \pm 1 \text{ Hz}$. See Figure 3-9 for A60R1's location.

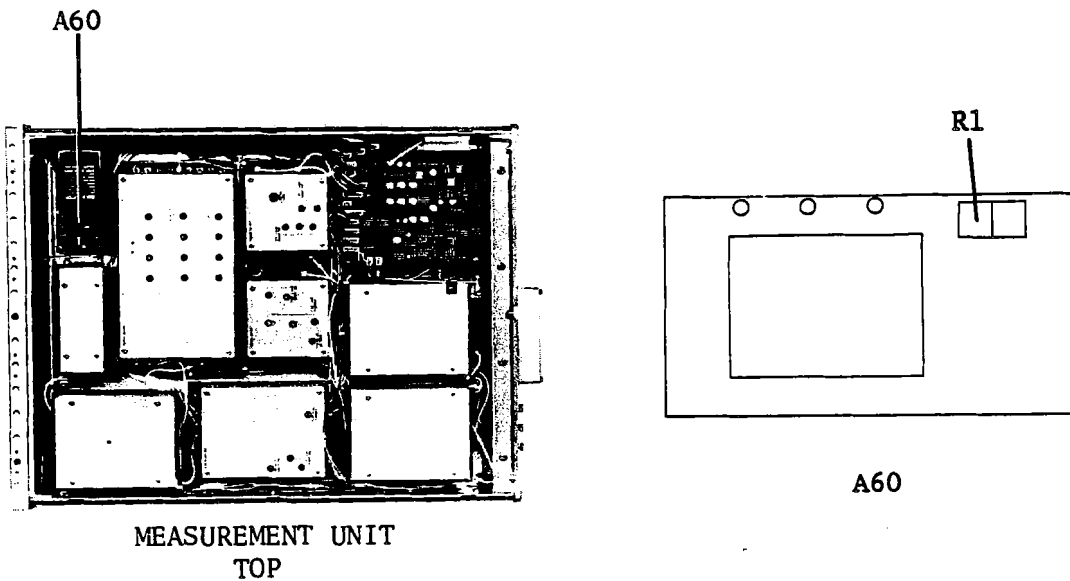

Figure 3-9. High Stability Oscillator Frequency Adjustment Location

3-10. CRT DISPLAY ADJUSTMENTS

3-10-1. CRT DISPLAY MODULE REMOVAL

The display module must be removed from the Control Unit to perform the following display adjustments. This paragraph describes how to remove the display module.

EQUIPMENT:

Display Module Extension Cable

PN 16349-61604

PROCEDURE:

1. Remove the 12 screws on the top and bottom of the front frame (they fasten the front panel to the frame).
2. Carefully pull the front panel part way out and disconnect the flat cable, then remove the front panel.
3. Remove the two screws which fasten the **INTENSITY** control to the chassis, then remove the **INTENSITY** control from the chassis.
4. Remove the four screws on the top of the display module as indicated in Figure 3-10.

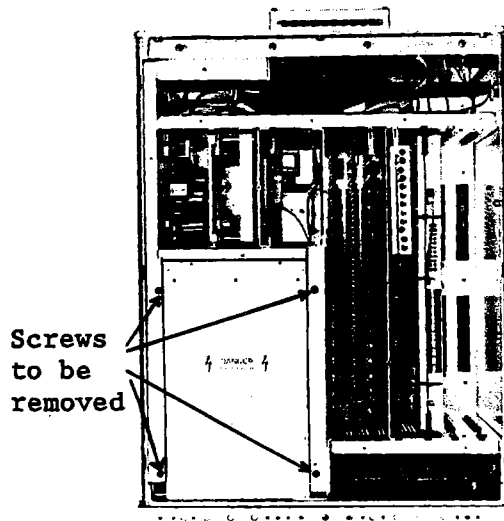

Figure 3-10. Screws to Be Removed

5. Slide the display module toward the front panel about 8 cm (3 inches), disconnect the flat cable from the display module, then slide the CRT section out of the Control Unit.
6. Reconnect the front panel flat cable to the A12 board and temporarily reassemble the front panel to the Control Unit.
7. Remove the six screws which fasten the top shield plate to the display module and remove the plate.

ADJUSTMENTS

8. Connect the Display Module Extension Cable between the display module and the flat cable.

CAUTION

Don't connect the flat cable and the extension cable in reverse. The extension cable is not keyed.

9. Place the display module near the HP 4195A as shown in Figure 3-12.

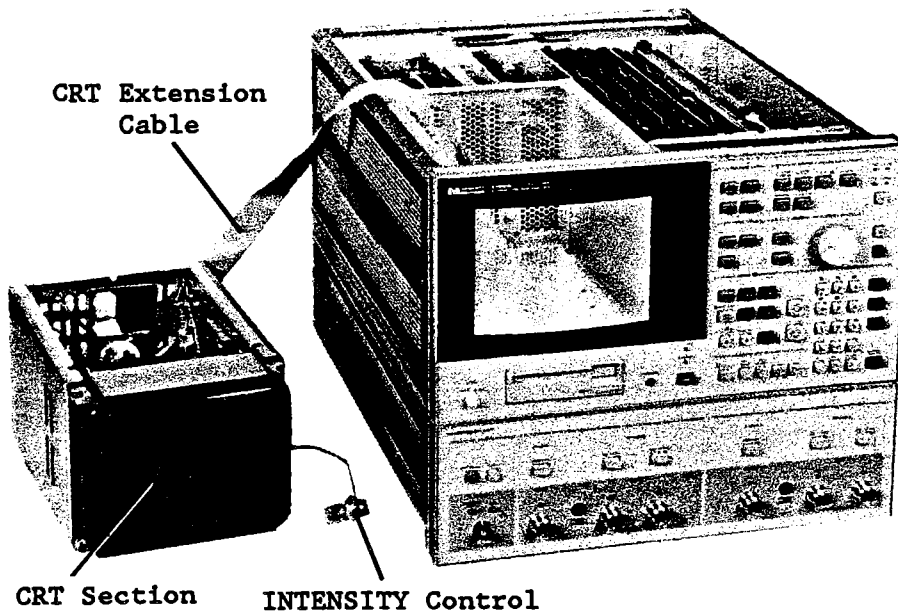

Figure 3-12. Display Adjustments Setup

3-10-2. LOCAL VOLTAGE REGULATOR ADJUSTMENT

This procedure adjusts the local voltage regulator output voltage for the display module.

EQUIPMENT:

Digital Voltmeter	HP 3456A
Dual Banana Plug to Alligator Clip Leads	HP 11002A

SUMMARY:

MONITOR:	High Lead:	A4TP18
	Low Lead:	A4TP17
ADJUSTMENT COMPONENT:		A4R67 (VOLT ADJ)

ADJUSTMENTS

TARGET:

Output Voltage: 48.0 V \pm 0.1 V

PROCEDURE:

1. Connect the equipment as shown in Figure 3-13. See Figure 3-14 for the location of A4TP17 and A4TP18.

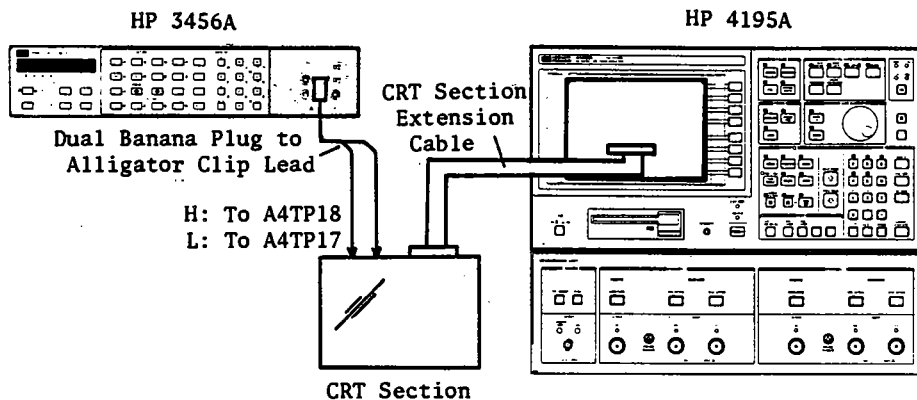

Figure 3-13. Local Voltage Regulator Adjustment Setup

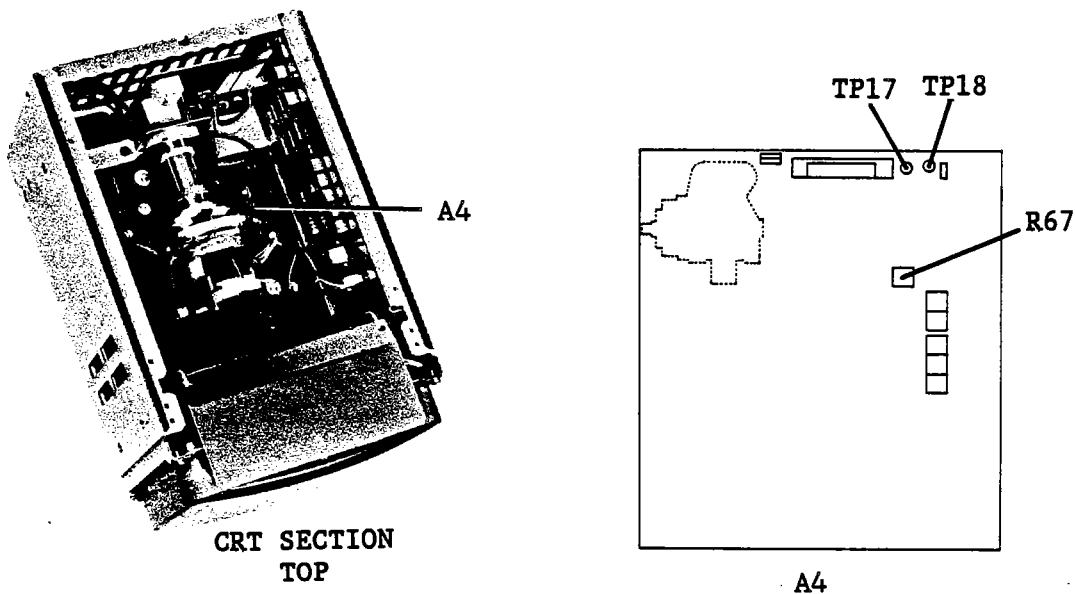

Figure 3-14. Local Voltage Regulator Adjustment Locations

2. Turn the HP 4195A on.
3. Adjust A4R67 until the Voltmeter reads 48.0 V \pm 0.1 V.

NOTE

If you are unable to adjust the voltage as specified, adjust the Power Supply as described in the section 3-8.

3-10-3. VERTICAL HOLD ADJUSTMENT

This procedure adjusts the vertical hold.

SUMMARY:

MONITOR: Service Function No. 90 display
ADJUSTMENT COMPONENT: A4R47 (V HOLD)
TARGET: The vertical deflection oscillator can lock-in both the highest and the lowest deflection frequencies generated by the service function.

PROCEDURE

1. Turn the HP 4195A on.
2. Enter the "STSET" command from the Keyboard Input Line, using the following key stroke sequence to display the Service Function Menu.

Blue shiftkey, S, T, S, E, T, ENTER/EXECUTE key

3. Enter the "STN=90" command using the following key stroke sequence.

'TEST No.' softkey (at the top), 9, 0, ENTER/EXECUTE key

4. Press the 'START' softkey. (at the top)

Look at the vertical hold adjustment test pattern displayed on the CRT as shown in Figure 3-15. The pattern will be displayed alternately in the upper and lower position on the CRT.

5. Adjust A4R47 (V HOLD) until the test pattern is stable at both the upper and lower positions. The correctly adjusted example in the Figure shows the pattern at the lower position.

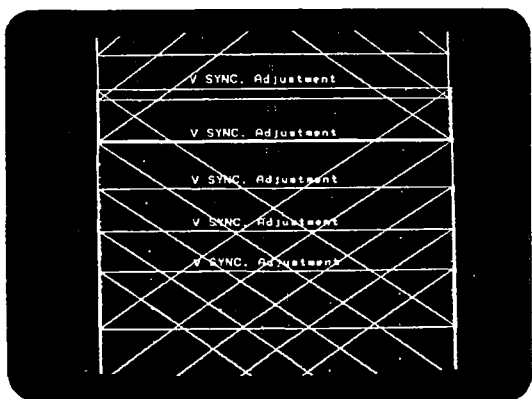

Incorrect Test Pattern

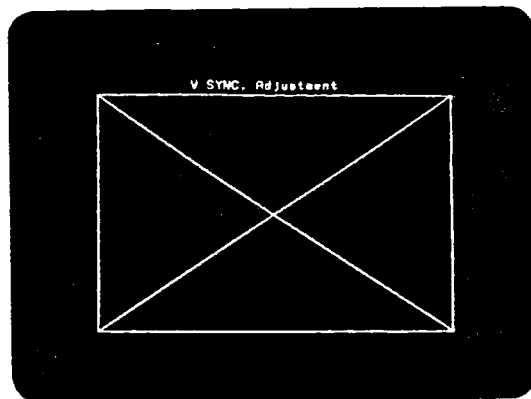

Correct Test Pattern

Figure 3-15. Vertical Hold Adjustment Test Pattern

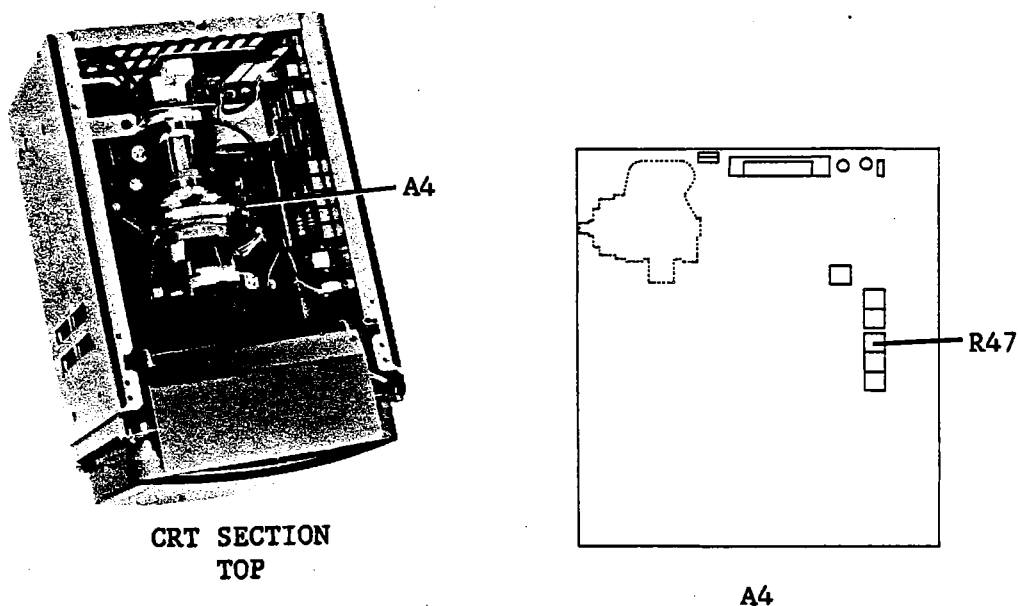

Figure 3-16. Vertical Hold Adjustment Location

6. Turn the HP 4195A off.

3-10-4. DISPLAY ADJUSTMENTS

This procedure adjusts the display position, size, and minimizes the pincushion distortion.

EQUIPMENT:

Template

PN 04195-69051

SUMMARY:

MONITOR:

Service Function No. 81 display

ADJUSTMENT COMPONENT:

A4L1 (H SIZE), R45 (PIN),
R46 (V SIZE), R48 (H HOLD)

TARGET:

To fit template's holes

PROCEDURE:

1. Install the template over the front of the CRT as shown in Figure 3-17.

NOTE

Place the display module on something so that the display module bottom is lifted about 3 cm (1 inch) off the surface of the workbench as shown in Figure 3-17, to keep the bottom of template from touching the workbench surface.

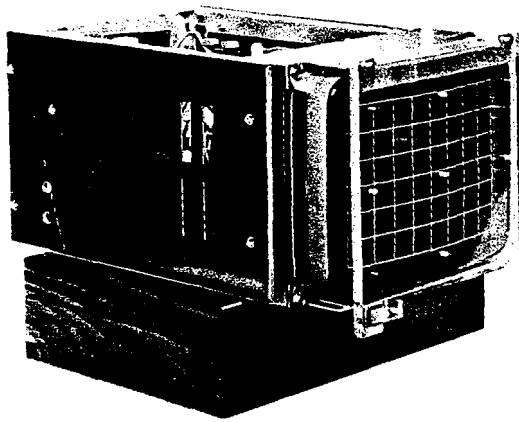

Figure 3-17. Display Adjustments Setup

2. Turn the HP 4195A on.
3. Enter the "STSET" command from the Keyboard Input Line, using the following key stroke sequence to display the Service Function Menu.

Blue shiftkey, S, T, S, E, T, ENTER/EXECUTE key

4. Enter the "STN=81" command using the following key strokes.

'TEST No.' softkey, 8, 1, ENTER/EXECUTE key

5. Press the 'START' softkey.

The display adjustment test pattern will be displayed on the CRT as shown in Figure 3-17.

6. Adjust A4L1 (H SIZE), R45 (PIN), R46 (V SIZE), R48 (H HOLD), and R49 (V POS) until the test pattern is within the test limits set by the template holes.

NOTE

If the horizontal position cannot be properly adjusted, perform the Horizontal Position Coarse Adjustment described in paragraph 3-10-5, otherwise proceed to the CRT Cutoff Adjustment in paragraph 3-10-6.

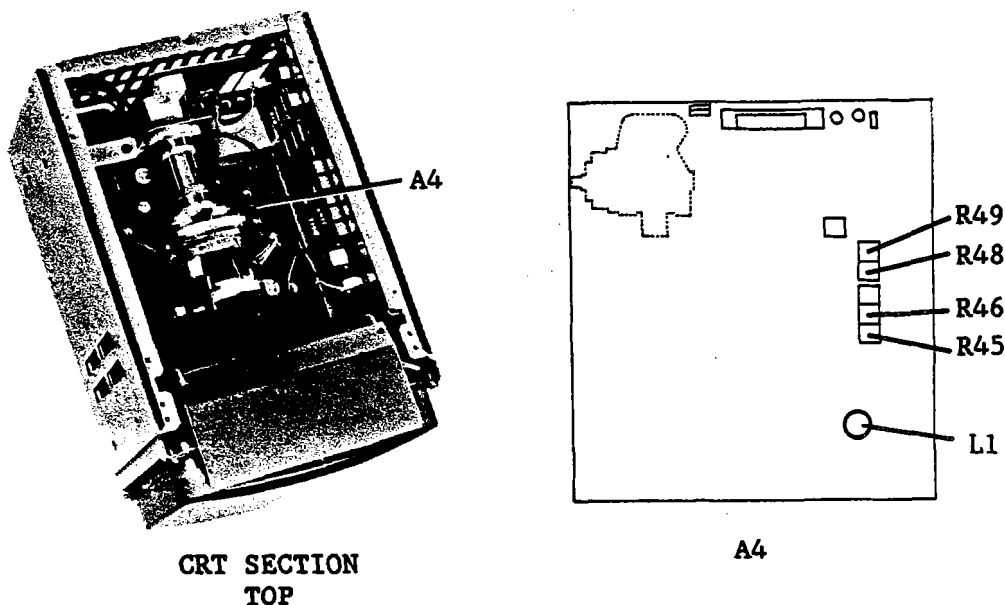

Figure 3-18. Display Adjustment Locations

3-10-5. HORIZONTAL POSITION COARSE ADJUSTMENT

This procedure adjusts the horizontal display position. This should be done only when the horizontal position cannot be adjusted in paragraph 3-10-4.

SUMMARY:

MONITOR:	Raster coverage area
ADJUSTMENT COMPONENT:	A4W1 and A4W2 Jumper Position
TARGET:	Horizontally Center

PROCEDURE

1. Turn the **INTENSITY** control fully counter clockwise (CCW).
2. Gradually turn **A4T3 (SCREEN)** clockwise (CW) until the screen is dimly illuminated. See Figure 3-19 for the **SCREEN** adjustment location.

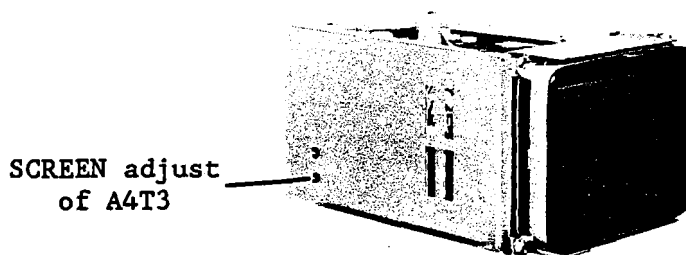
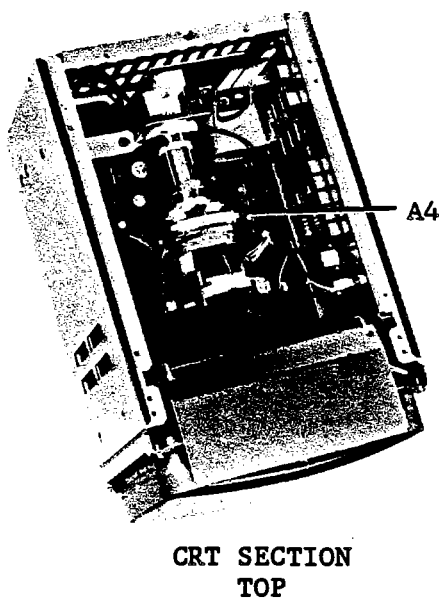
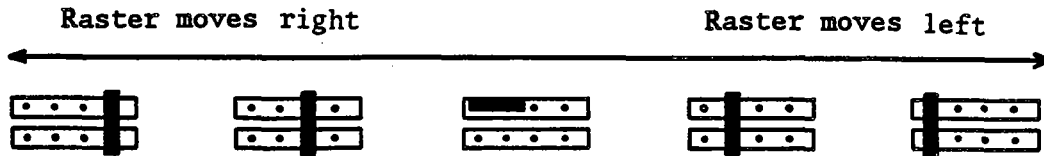

Figure 3-19. Horizontal Position Coarse Adjustment Location

3. Turn **A4R48** to approximately its midrange.

ADJUSTMENTS

4. You will see the raster (illuminated area) is not in the center. Determine to which direction to move the raster should on the display.
5. Turn the HP 4195A off.
6. Place jumper (A4W1 and A4W2) in one of the positions shown in Figure 3-20 to move the illuminated area to the center.
7. Turn the HP 4195A on. Repeat steps 4 through 7 until the area is centered.



CRT SECTION
TOP

Horizontal Position Adjustment
Jumper (W1 and W2)

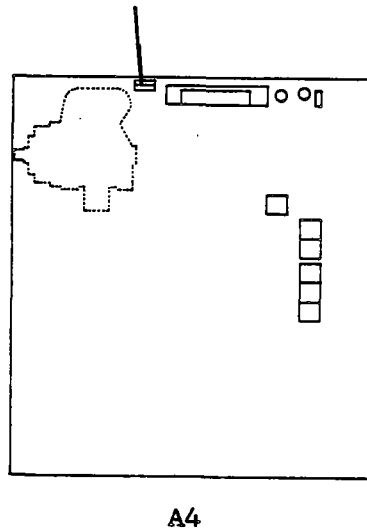

Figure 3-20. Horizontal Position Adjustment Jumper Setting

8. Gradually turn the A4T3 (SCREEN) adjustment counter clockwise (CCW) until the screen is not illuminated.
9. Turn the INTENSITY control clockwise (CW) until the screen is properly illuminated.

NOTE

After this adjustment, repeat the Display Adjustments described in paragraph 3-10-4.

3-10-6. CRT CUTOFF ADJUSTMENT

This procedure adjusts the cutoff voltage of the green and blue CRT guns.

ADJUSTMENTS

SUMMARY:

MONITOR:	Background color
ADJUSTMENT COMPONENT:	A5R4 (B CUTOFF), A5R11 (G CUTOFF)
TARGET:	No tint

PROCEDURE

1. Turn the HP 4195A off.
2. Turn the INTENSITY control fully counter clockwise (CCW).
3. Set jumper A4W3 to the TEST position as shown in Figure 3-21.

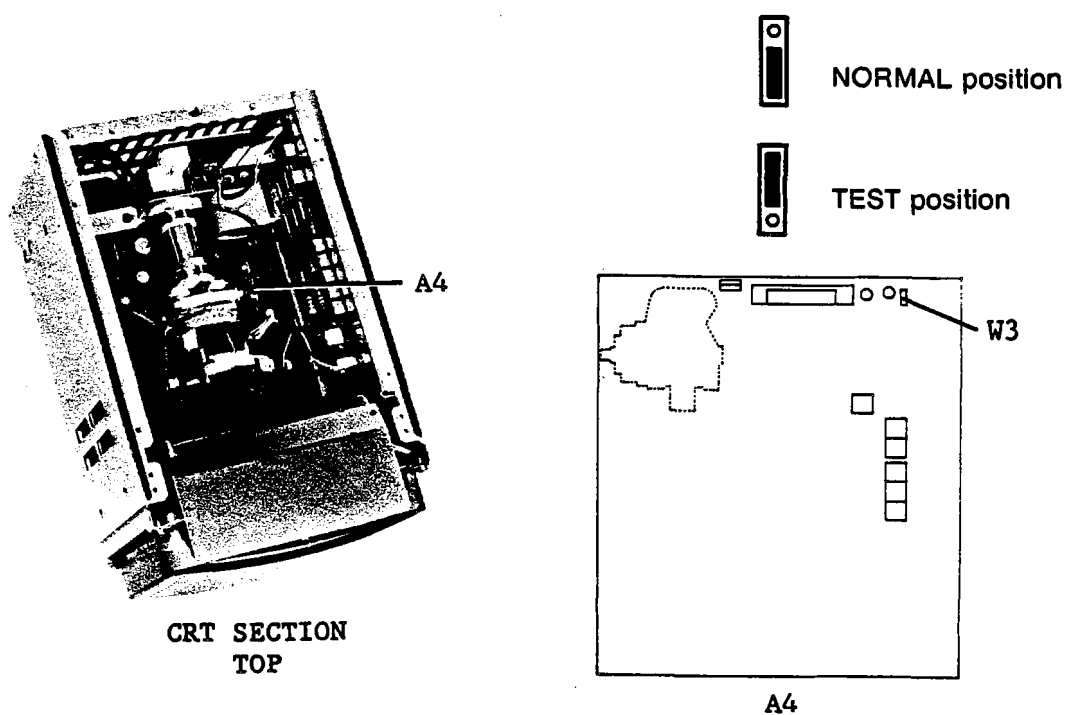

Figure 3-21. CRT Cutoff Test Jumper Locations

4. Turn the HP 4195A on.

NOTE

A horizontal line will be displayed in the center of the screen. If the color of the line is untinted gray, skip to step 9, otherwise, start the procedure at step 5.

5. Turn A4T3 (SCREEN) fully counter clockwise (CCW). See Figure 3-22 for the SCREEN adjustment location.

ADJUSTMENTS

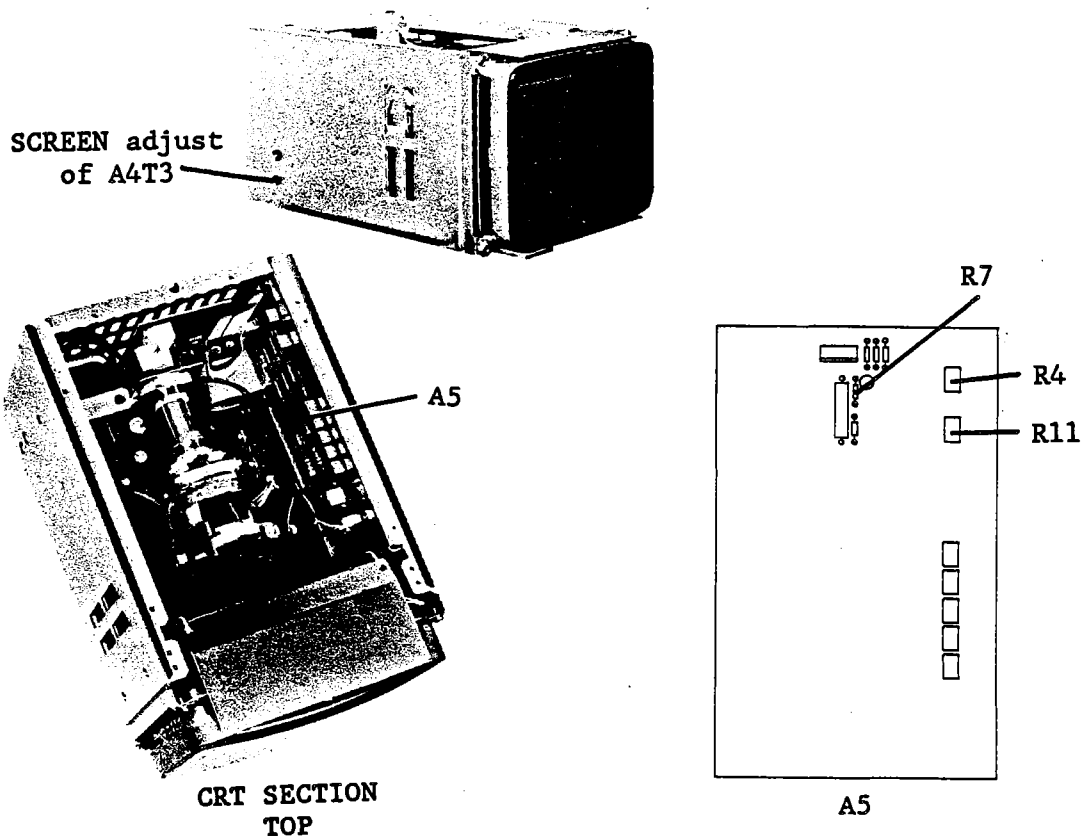

Figure 3-22. CRT Cutoff Adjustment Locations

6. Turn A5R4 (B CUTOFF) and A5R11 (G CUTOFF) fully counter clockwise (CCW).
7. Gradually turn the **SCREEN** adjust clockwise (CW) until a red trace in the center of the screen is dimly illuminated.
8. Adjust A5R4 (B CUTOFF) and A5R11 (G CUTOFF) until the red trace is untinted gray.

NOTE

If you are unable to adjust the trace as described in step 8, change the value of resistor A5R7 as follows, and repeat the preceding procedure.

The trace is still red, even though A5R4 or A5R11 are turned fully clockwise:
Replace A5R7 with a 6.19 k Ω resistor (PN 0757-0290).

The trace is still yellow, even though A5R4 or A5R11 are turned fully counter clockwise:
Replace A5R7 with a 19.6 k Ω resistor (PN 0698-3157).

9. Turn the HP 4195A off.
10. Reset jumper A4W3 to the **NORMAL** position as shown in Figure 3-21.

ADJUSTMENTS

3-10-7. WHITE BALANCE ADJUSTMENT

This procedure adjusts the balance of the blue and green color drivers.

SUMMARY:

MONITOR:	Service Function No. 86 display
ADJUSTMENT COMPONENT:	A5R30 (BH), A5R32 (GH), A5R31 (BL), A5R33 (GL)
TARGET:	Untinted shade of gray

PROCEDURE:

1. Turn A5R34 (INT-LIM) fully counter clockwise (CCW) and turn the INTENSITY control fully clockwise (CW). See Figure 3-24 for A5R34 location.
2. Turn the HP 4195A on.
3. Enter the "STSET" command from the Keyboard Input Line using the following key stroke sequence to display the Service Function Menu.

Blue shiftkey, S, T, S, E, T, ENTER/EXECUTE key

4. Enter the "STN=86" command using the following key stroke sequence.

'TEST No.' softkey, 8, 6, ENTER/EXECUTE key

5. Press the 'START' softkey.

The white balance adjustment test pattern will be displayed on the CRT.

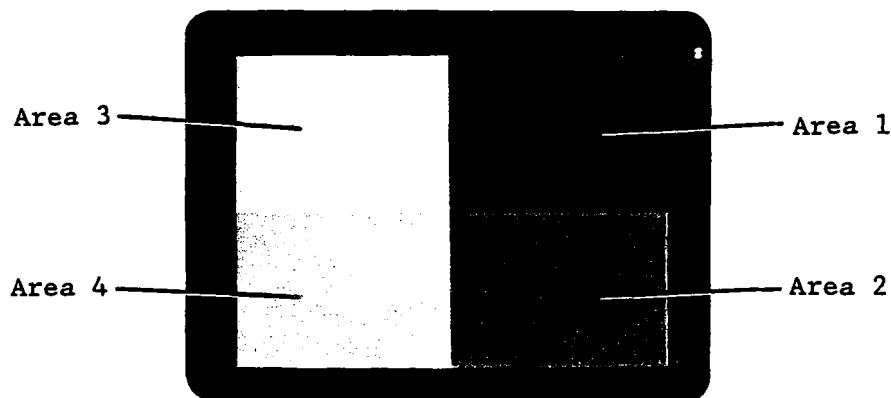

Figure 3-23. White Balance Adjustment Test Pattern

6. Adjust A5R30 (BH), and A5R32 (GH) until the color of the lower left area (Area 4 in Figure 3-23) is untinted shade of gray.

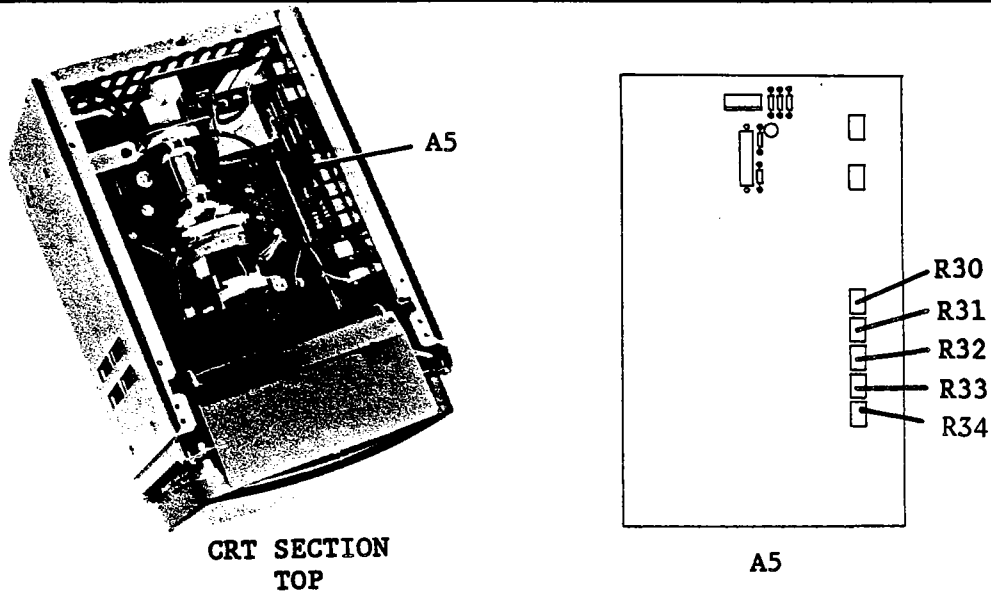

Figure 3-24. White Balance Adjustment Locations

7. Adjust A5R31 (BL), and A5R33 (GL) until the color of the lower right area (Area 2 in Figure 3-23) is an untinted shade of gray.
8. Check that the color of the upper left area (Area 3 in Figure 3-23) is white (no tint). If not, repeat steps 6 and 7 until it is balanced.
9. Press the second softkey from the top to stop the test, then press the 'EXIT' softkey.

3-10-8. MAXIMUM INTENSITY ADJUSTMENT

This procedure adjusts the maximum intensity limit of the display.

SUMMARY:

MONITOR:	Service Function No. 81 display
ADJUSTMENT COMPONENT:	A17R1 (INT-LIM)
TARGET:	No overshoot at the graticule's right edge

PROCEDURE:

1. Turn A5R34 (INT-LIM) fully clockwise (CW), and turn the INTENSITY control fully clockwise (CW). See Figure 3-26 for A5R34's location.
2. Enter the "STSET" command from the Keyboard Input Line, using the following key stroke sequence to display the Service Function Menu.

Blue shiftkey, S, T, S, E, T, ENTER/EXECUTE key

3. Enter the "STN=81" command using the following key stroke sequence.

'TEST No.' softkey, 8, 1, ENTER/EXECUTE key

ADJUSTMENTS

4. Press the 'START' softkey.

The maximum intensity adjustment test pattern will be displayed on the CRT as shown in Figure 3-25.

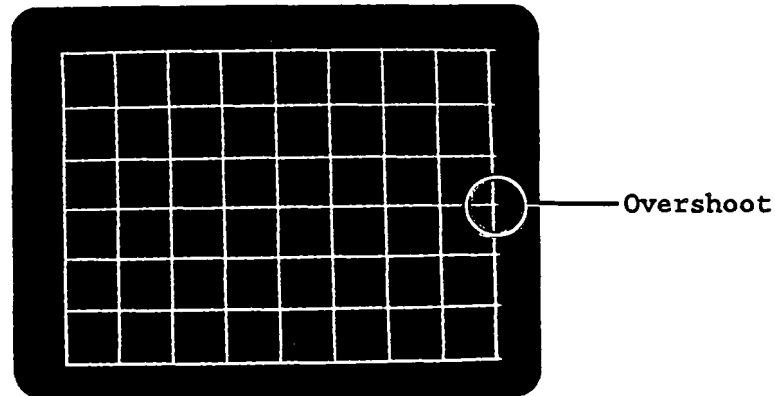

Figure 3-25. Maximum Intensity Adjustment Test Pattern

5. Note the overshoot that extends to the right of each horizontal line on the displayed graticule. Adjust A5R34 (INT-LIM) until the overshoot disappears.

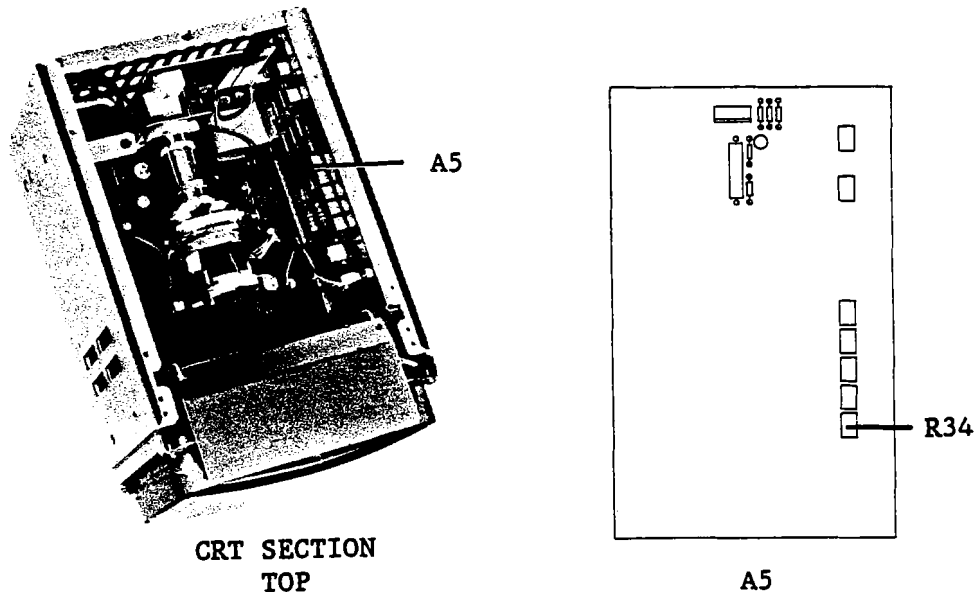

Figure 3-26. Maximum Intensity Adjustment Locations

6. Press the second softkey from the top to stop the test operation, then press the 'EXIT' softkey.

3-10-9. FOCUS, CONVERGENCE, AND INTENSITY ADJUSTMENT

This procedure adjusts the display's focus and convergence of the display.

ADJUSTMENTS

SUMMARY:

MONITOR:	Service Function No. 83 display
ADJUSTMENT COMPONENT:	INTENSITY control, A4T3 FOCUS adjust, A17R1 (CONVERGENCE)
TARGET:	Focused convergence

PROCEDURE:

1. Adjust the **INTENSITY** control for the proper display intensity.
2. Enter the "**STSET**" command from the Keyboard Input Line using the following key stroke sequence to display the Service Function Menu.

Blue shiftkey, S, T, S, E, T, ENTER/EXECUTE key

3. Enter the "**STN=83**" command using the following key stroke sequence.

'TEST No.' softkey, 8, 3, ENTER/EXECUTE key

4. Press the **'START'** softkey.

The focus, convergence, and intensity adjustment test pattern will be displayed on the CRT as shown in Figure 3-27.

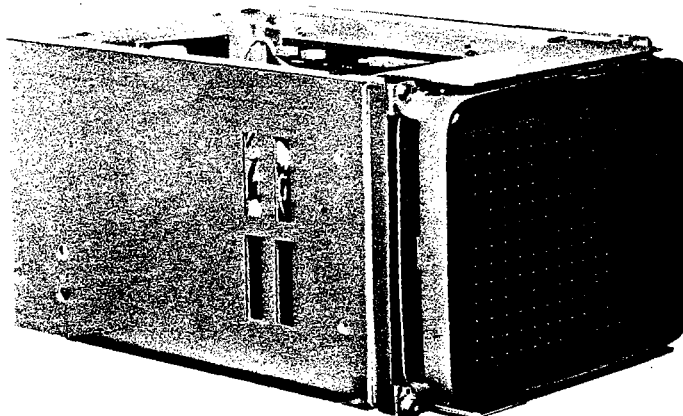

Figure 3-27. Focus, Convergence, and Intensity Adjustment Test Pattern

5. Adjust the **A4T3 (FOCUS)** until the test pattern dots are simultaneously in focus at the center, corners, and edges.
6. Adjust **A17R1 (CONVERGENCE)** until the red, green, and blue dots converge and are focused as single dots on the display.

ADJUSTMENTS

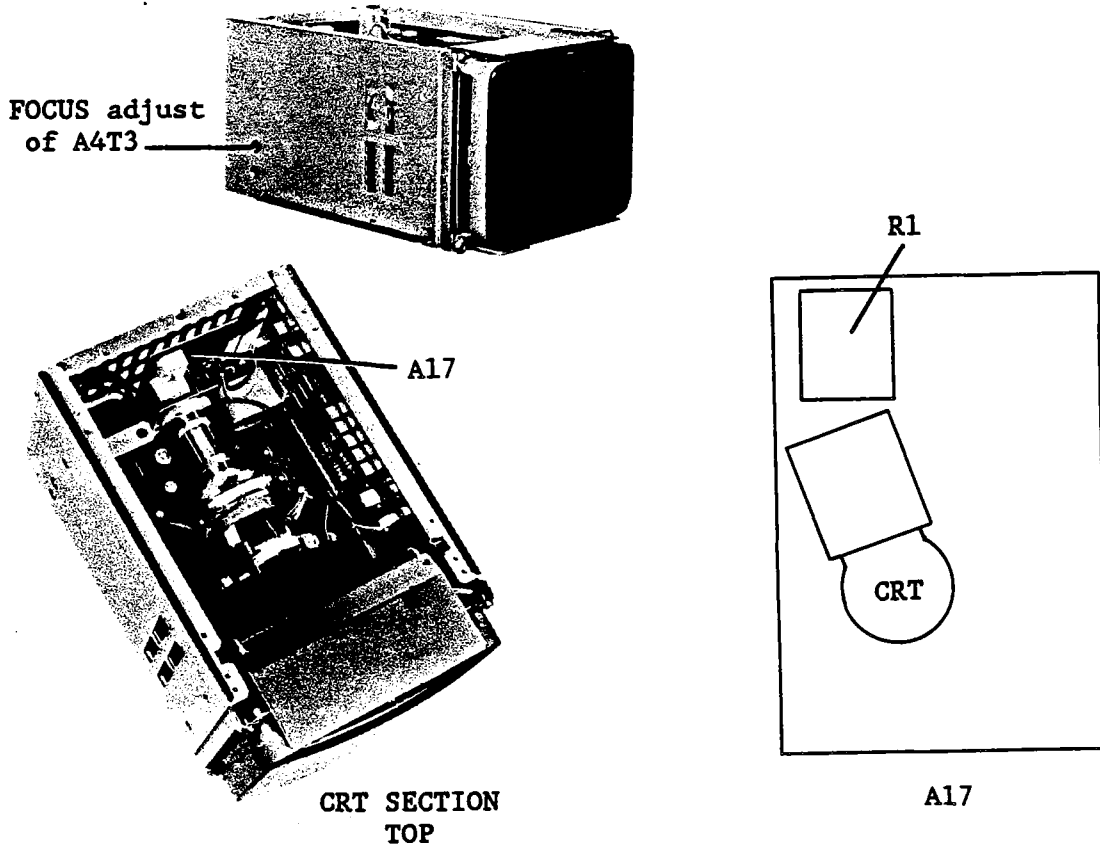

Figure 3-28. Focus, Convergence, and Intensity Adjustment Locations

3-11. FREQUENCY GENERATOR ADJUSTMENT

3-11-1. 80 MHz REFERENCE SOURCE LEVEL ADJUSTMENT

This procedure adjusts the output level of the 80 MHz reference source.

NOTE

A10 board (PN 04195-66519) with rev. code D-2939 or later does not have this adjustment. If such a board is installed on your unit, skip this (REF LEVEL) adjustment.

NOTE

If the unit's S/N is 2830J and below, adjust as described in the Appendix A.

EQUIPMENT:

Spectrum Analyzer	HP 8568B
BNC(m)-BNC(m) Cable, 122 cm	PN 8120-1840
BNC(m)-SMB(f) Cable, 122 cm	PN 85680-60093
SMB(m)-SMB(m) Adapter	PN 1250-0813
N(m)-BNC(f) Adapter	PN 1250-0780
Extender Board	PN 04195-66590

SUMMARY:

MONITOR:	Cable (J) (80 MHz OUT) from A10 Board
ADJUSTMENT COMPONENT:	A10C1 (REF LEVEL ADJ)
TARGET:	Output Level: -8.0 dBm \pm 0.3 dBm

PROCEDURE:

1. Disconnect a coaxial cable (J) from A18J10.
2. Extend the A10 board. Connect the equipment as shown in Figure 3-31.

ADJUSTMENTS

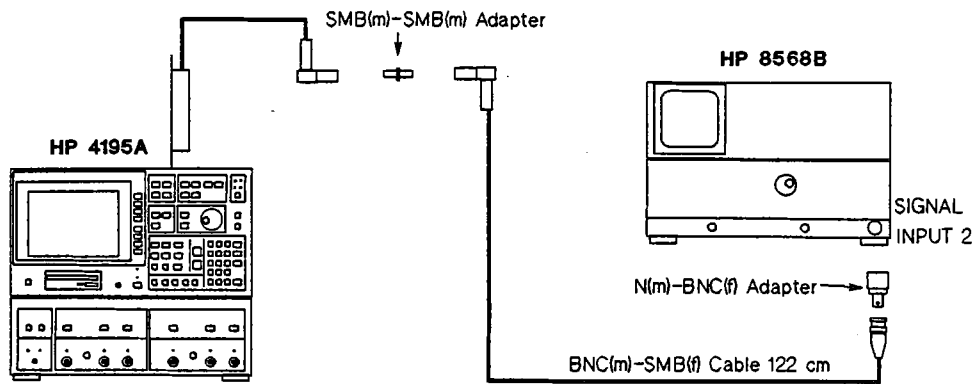

Figure 3-31. 80 MHz Reference Source Level Adjustment Setup

3. Set up the Spectrum Analyzer as follows.

CENTER FREQUENCY
SPAN

80 MHz
1 MHz

4. Turn the HP 4195A on.

5. Adjust A10C1 (REF LEVEL ADJ) until the 80 MHz signal level is $-8.0 \text{ dBm} \pm 0.3 \text{ dB}$.

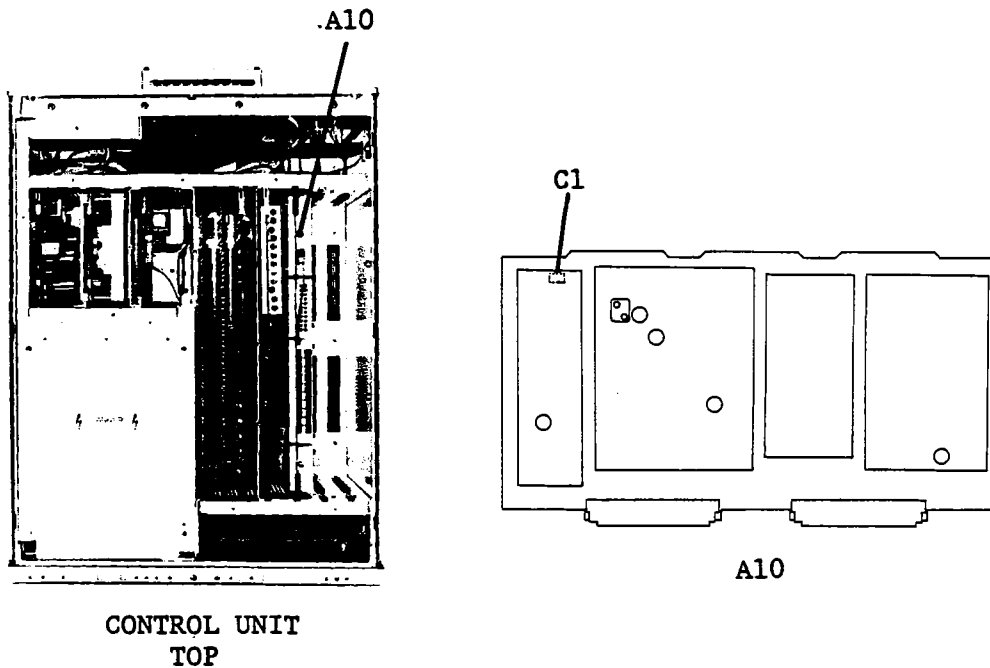

Figure 3-32. 80 MHz Reference Source Level Adjustment Locations

6. Reconnect the cable (J) to A18J10.

3-11-2. 80 MHz REFERENCE SOURCE FREQUENCY ADJUSTMENT

This procedure adjusts the frequency of the 80 MHz reference source.

ADJUSTMENTS

EQUIPMENT:

Frequency Counter
BNC(m)-BNC(m) Cable, 50 Ω , 122 cm
Extender Board

HP 5385A
PN 8120-1840
PN 04195-66590

SUMMARY:

MONITOR: J3 (80 MHz OUT) on Control Unit rear panel

ADJUSTMENT COMPONENT: A10A4R11 (REF FREQ ADJ)

TARGET: Output Frequency: 80 MHz \pm 80 Hz

PROCEDURE:

1. Extend the A10 board.
2. Connect the equipment as shown in Figure 3-33. Leave the **EXT REFERENCE** connector on the Control Unit rear panel unconnected.

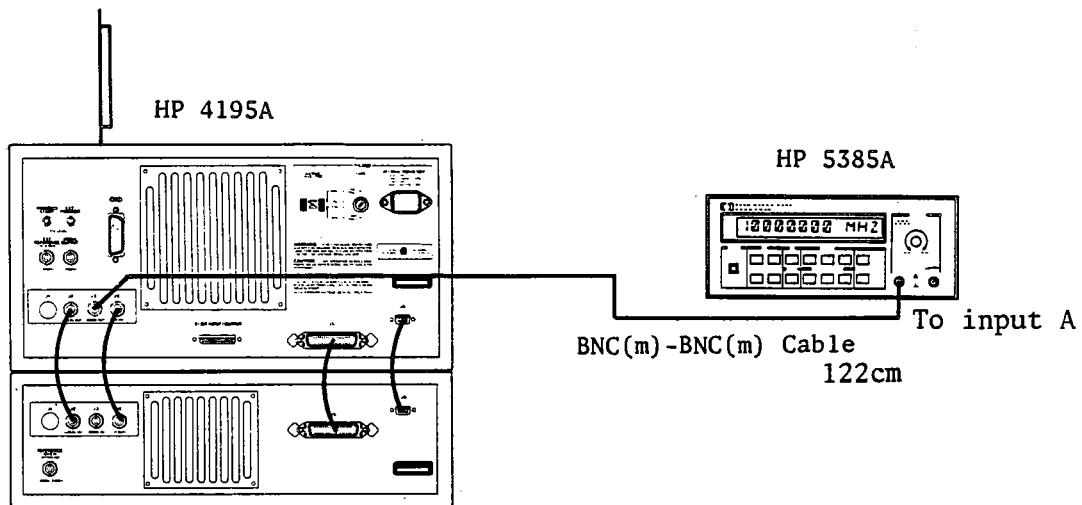

Figure 3-33. 80 MHz Reference Source Frequency Adjustment Setup

ADJUSTMENTS

3. Adjust A10A4R11 (REF FREQ ADJ) until the Counter reads 80 MHz \pm 80 Hz.

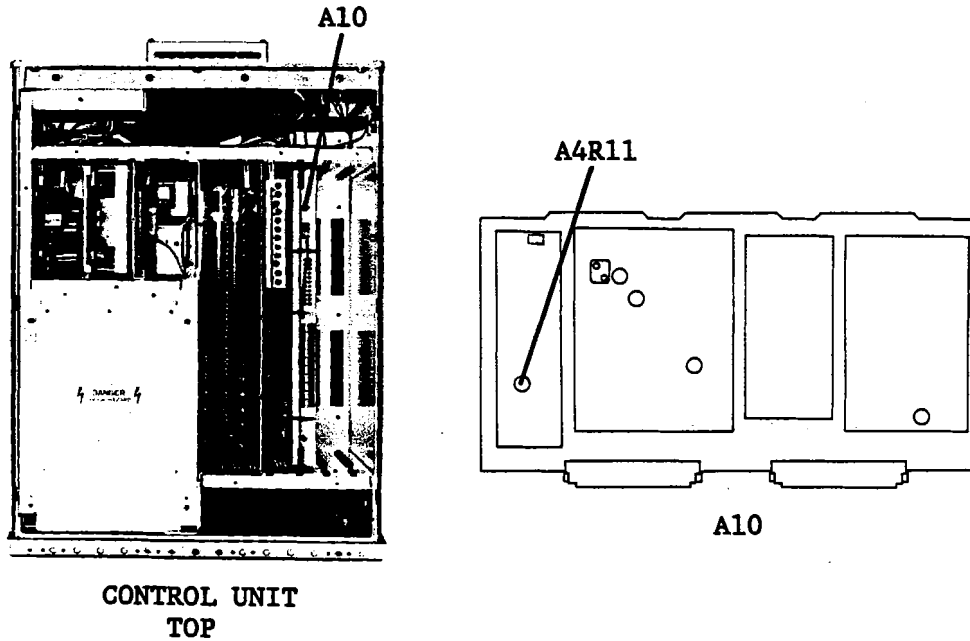

Figure 3-34. 80 MHz Reference Source Frequency Adjustment Locations

3-12. VCO OUTPUT SPURIOUS REJECTION ADJUSTMENTS

This procedure minimizes the spurious signals from the fractional N PLL output.

EQUIPMENT:

Spectrum Analyzer	HP 8568B	
BNC(m)-BNC(m) Cable, 50Ω, 122 cm	PN 8120-1840	2 ea.
N(m)-BNC(f) Adapter	PN 1250-0780	
Extender Board	PN 04195-66590	

3-12-1. 100 kHz SPURIOUS REJECTION ADJUSTMENT

This procedure minimizes the 100 kHz spurious levels in VCO output.

SUMMARY:

MONITOR:	J2 (LOCAL OUT) on Control Unit rear panel
ADJUSTMENT COMPONENT:	A10A6R12 (100 kHz NULL ADJ)
TARGET:	Minimum (≤ -80 dBc) at 234 MHz ± 100 kHz

PROCEDURE:

1. Extend the A10 board.
2. Connect the equipment as shown in Figure 3-35.

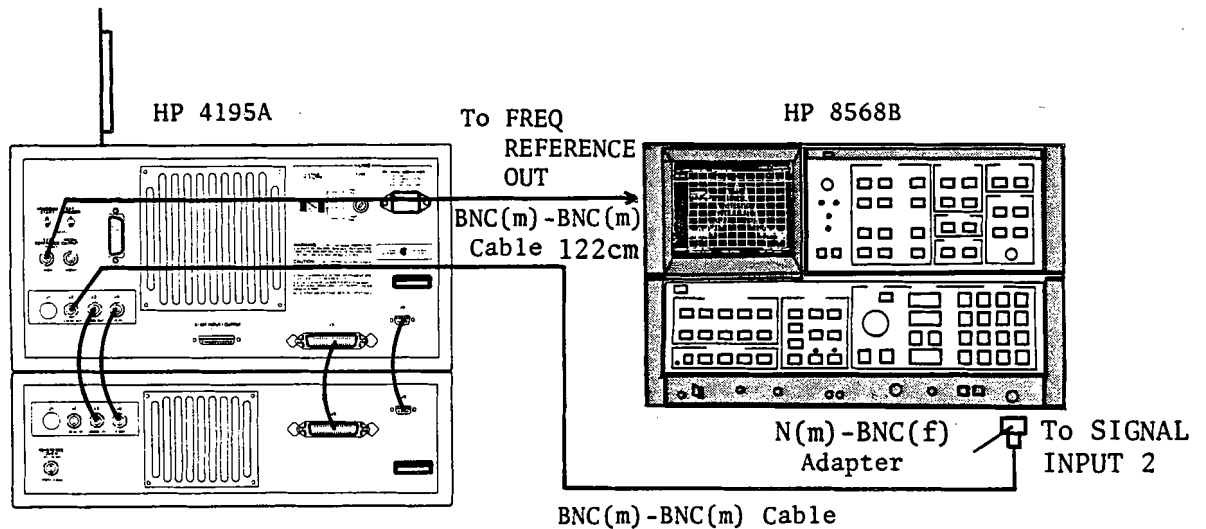

Figure 3-35. 100 kHz Spurious Rejection Adjustment Setup

ADJUSTMENTS

3. Set up the HP 4195A as follows.

		COMMAND
CONFIGURATION	NETWORK	FNC1
INITIALIZE	PRESET	RST
CENTER FREQUENCY	320.666 666 667 MHz	CENTER=320.666666667M
FREQUENCY SPAN	5 MHz	SPAN=5M
SWEEP TRIGGER MODE	MANUAL	SWM3
MANUAL FREQUENCY	320.666 666 667 MHz	MANUAL=320.666666667M

NOTE

Use the **MARKER/LINE CURSOR** knob to control **MANUAL** frequency.

4. Set up the Spectrum Analyzer as follows.

CENTER FREQUENCY	234 MHz
SPAN	300 kHz
RES BW	300 Hz

5. Note the Spectrum Analyzer's reading of the 234 MHz fundamental signal level (Figure 3-36 (1)).

NOTE

The fundamental signal level should be from 0 dBm to +3 dBm. If it is not, repeat the steps 1 through 5.

6. Change the Spectrum Analyzer setup as follows.

CENTER FREQUENCY	234.1 MHz
SPAN	0 Hz
RES BW	100 Hz
VIDEO BW	100 Hz
SWEEP TIME	75 sec

ADJUSTMENTS

7. Adjust A10A6R12 (100 kHz NULL ADJ) until the 100 kHz sideband spurious signal level is minimum and < -80 dBc. Figure 3-34 (2) shows a correctly adjusted trace.

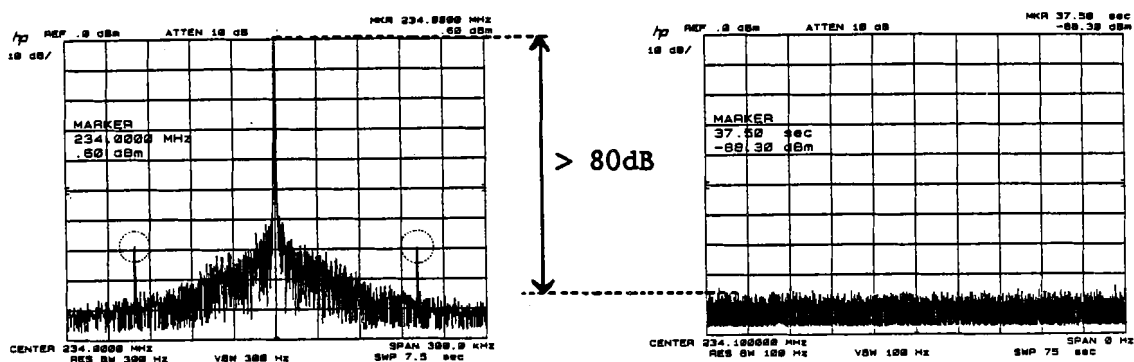

(1) Spectrum of step 5

(2) Display of step 7

Figure 3-36. 100 kHz Spurious Spectrum

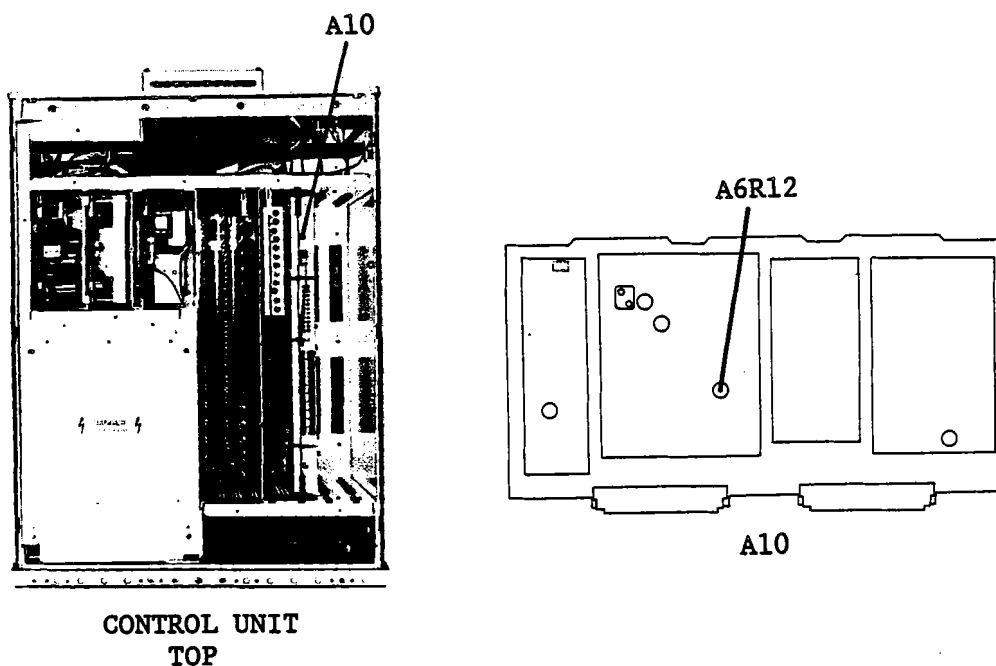

Figure 3-37. 100 kHz Spurious Rejection Adjustment Location

3-12-2. API ADJUSTMENTS

These procedures adjust the Frequency Generator API1, API2, API3, and API4 Current Sources.

SUMMARY:

MONITOR:

J2 (LOCAL OUT) on Control Unit rear panel

ADJUSTMENT COMPONENTS:

A10A1R28 (API1 ADJ)
 A10A1R14 (API2 ADJ)
 A10A1R15 (API3 ADJ)
 A10A1R5 (API4 ADJ)

ADJUSTMENTS

TARGETS: Minimum (≤ -63 dBc) at 234.1 MHz ± 10 kHz (API1 ADJ)
 Minimum (≤ -70 dBc) at 234.01 MHz ± 10 kHz (API2 ADJ)
 Minimum (≤ -80 dBc) at 234.001 MHz ± 10 kHz (API3 ADJ)
 Minimum (≤ -80 dBc) at 234.0001 MHz ± 10 kHz (API4 ADJ)

PROCEDURE:

1. Extend the A10 board.
2. Connect the equipment as shown in Figure 3-38.

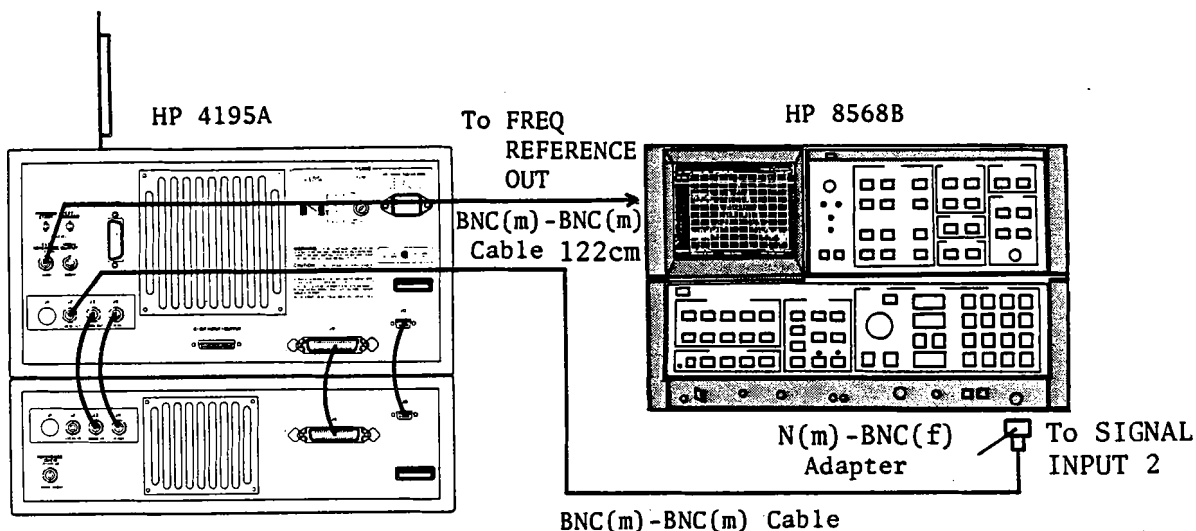

Figure 3-38. API Adjustments Setup

API1 ADJUSTMENT

3. Set up the HP 4195A as follows.

COMMAND

CONFIGURATION	NETWORK	FNC1
INITIALIZE	PRESET	RST
CENTER FREQUENCY	320.766 666 667 MHz	CENTER=320.766666667M
FREQUENCY SPAN	5 MHz	SPAN=5M
SWEEP TRIGGER MODE	MANUAL	SWM3
MANUAL FREQUENCY	320.766 666 667 MHz	MANUAL=320.766666667M

NOTE

Use the **MARKER/LINE CURSOR** knob to manually control the frequency.

4. Set up the Spectrum Analyzer as follows.

CENTER FREQUENCY	234.1 MHz
REFERENCE LEVEL	10 dBm
SPAN	50 kHz
RES BW	300 Hz

ADJUSTMENTS

- Note the Spectrum Analyzer's reading of the 234.1 MHz fundamental signal level.

NOTE

The fundamental signal level should be from 0 dBm to +3 dBm. If it is not, repeat the steps 1 through 5.

- Change the Spectrum Analyzer setup as follows.

CENTER FREQUENCY	234.11 MHz
SPAN	2 kHz
RES BW	30 Hz
VIDEO BW	30 Hz

- Find the highest spurious near the center frequency. If the spurious signal level is < -63 dBc, proceed to step 10.

- Change the Spectrum Analyzer setup as follows.

CENTER	the spurious frequency
SPAN	0 Hz
RES BW	30 Hz
VIDEO BW	1 Hz
SWEEP TIME	10 sec

- Adjust A10A1R28 (API1 ADJ) until the Spectrum Analyzer displays the minimum spurious signal level and < -63 dBc.

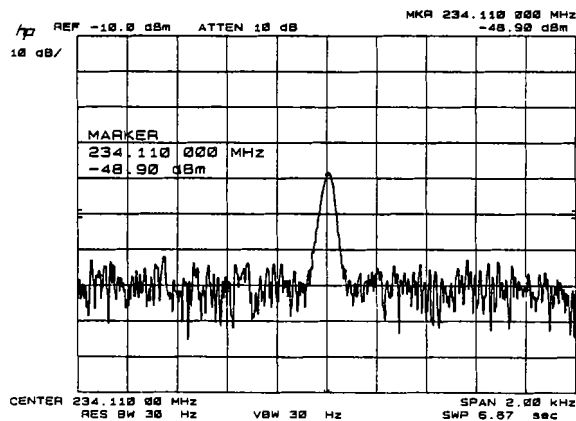

Figure 3-39. Display of the API1 Adjustment

ADJUSTMENTS

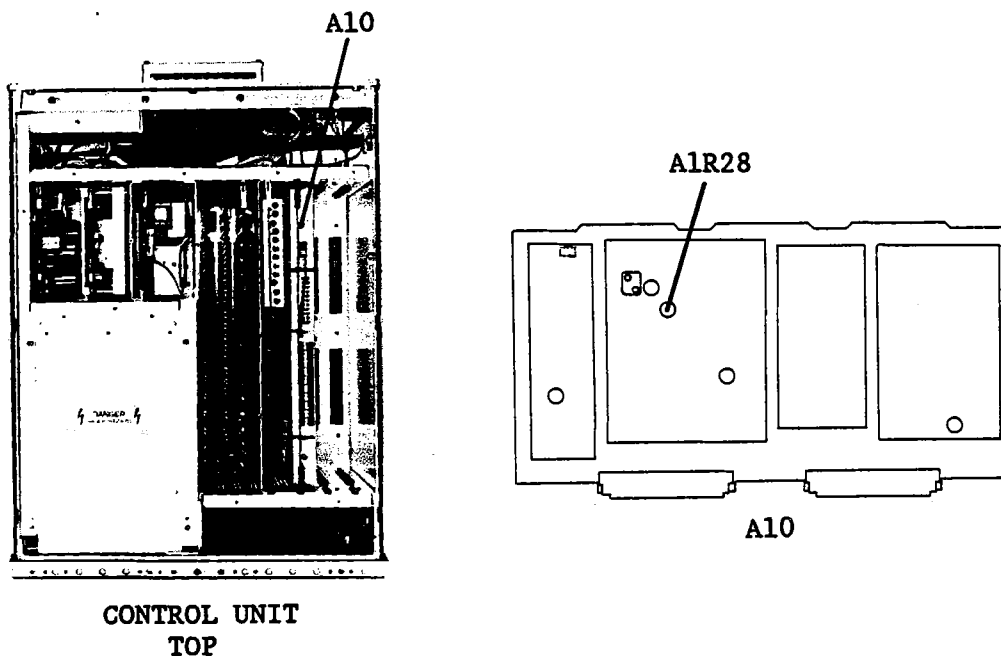

Figure 3-40. API1 Adjustment Locations

API2 ADJUSTMENT

10. Change the HP 4195A setup as follows. The rest of the setup should be the same as the setup in step 3.

COMMAND

CENTER FREQUENCY	320.676 666 667 MHz	CENTER=320.676666667M
MANUAL FREQUENCY	320.676 666 667 MHz	MANUAL=320.676666667M

11. Preset the Spectrum Analyzer, and set it up as follows.

CENTER FREQUENCY	234.01 MHz
REFERENCE LEVEL	10 dBm
SPAN	50 kHz
RES BW	300 Hz

12. Note the Spectrum Analyzer's reading of the 234.01 MHz fundamental signal level.

NOTE

The fundamental signal level should be from 0 dBm to +3 dBm. If it is not, repeat the steps 10 through 12.

13. Change the Spectrum Analyzer setup as follows.

CENTER FREQUENCY	234.02 MHz
SPAN	2 kHz
RES BW	30 Hz
VIDEO BW	30 Hz

14. Find the highest spurious near the center frequency. If the spurious signal level is < -70 dBc, proceed to step 17.

ADJUSTMENTS

15. Change the Spectrum Analyzer setup as follows.

CENTER	the spurious frequency
SPAN	0 Hz
RES BW	30 Hz
VIDEO BW	1 Hz
SWEEP TIME	10 sec

16. Adjust A10A1R14 (API2 ADJ) until the Spectrum Analyzer displays the minimum spurious signal level and it is < -70 dBc.

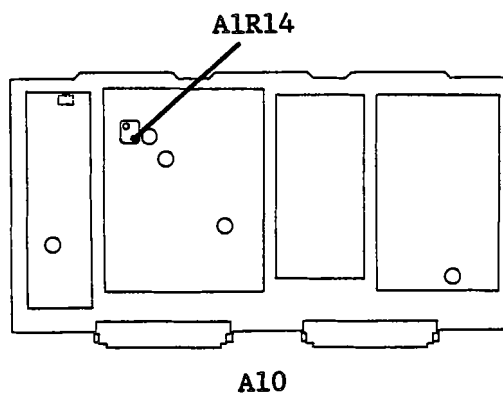

Figure 3-41. API2 Adjustment Location

API3 ADJUSTMENT

17. Change the HP 4195A setup as follows, the rest of the setup should be the same as the set up in step 3.

COMMAND

CENTER FREQUENCY	320.667 666 667 MHz	CENTER=320.667666667M
MANUAL FREQUENCY	320.667 666 667 MHz	MANUAL=320.667666667M

18. Preset the Spectrum Analyzer, and set it up as follows.

CENTER FREQUENCY	234.001 MHz
REFERENCE LEVEL	10 dBm
SPAN	50 kHz
RES BW	300 Hz

19. Note the Spectrum Analyzer's reading of the 234.001 MHz fundamental signal level.

NOTE

The fundamental signal level should be from 0 dBm to +3 dBm. If it is not, repeat the steps 17 through 19.

20. Change the Spectrum Analyzer setup as follows.

CENTER FREQUENCY	234.011 MHz
SPAN	2 kHz

ADJUSTMENTS

RES BW	30 Hz
VIDEO BW	30 Hz

21. Find the highest spurious near the center frequency. If the spurious signal level is < -70 dBc, proceed to step 24.

22. Change the Spectrum Analyzer setup as follows.

CENTER	the spurious frequency
SPAN	0 Hz
RES BW	30 Hz
VIDEO BW	1 Hz
SWEEP TIME	10 sec

23. Adjust A10A1R15 (API3 ADJ) until the Spectrum Analyzer displays the minimum spurious signal level and it is < -70 dBc.

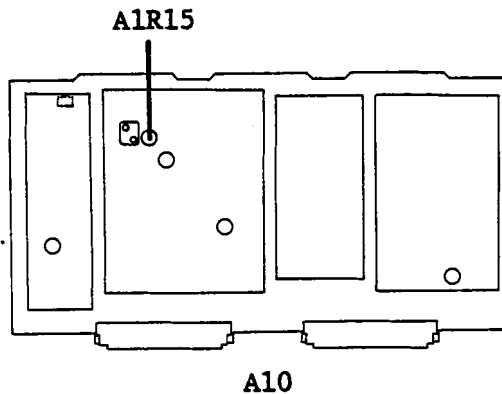

Figure 3-42. API3 Adjustment Location

API4 ADJUSTMENT

24. Change the HP 4195A setup as follows, the rest of the setup should be the same as set in step 3.

COMMAND		
CENTER FREQUENCY	320.666 766 667 MHz	CENTER=320.666766667M
MANUAL FREQUENCY	320.666 766 667 MHz	MANUAL=320.666766667M

25. Preset the Spectrum Analyzer, and set it up as follows.

CENTER FREQUENCY	234.0001 MHz
REFERENCE LEVEL	10 dBm
SPAN	50 kHz
RES BW	300 Hz

26. Note the Spectrum Analyzer's reading of the 234.0001 MHz fundamental signal level.

NOTE

The fundamental signal level should be from 0 dBm to +3 dBm. If it is not, repeat the steps 24 through 26.

ADJUSTMENTS

27. Change the Spectrum Analyzer setup as follows.

CENTER FREQUENCY	234.0101 MHz
SPAN	2 kHz
RES BW	30 Hz
VIDEO BW	30 Hz

28. Find the highest spurious near the center frequency. If the spurious signal level is < -70 dBc, finish this procedure.

29. Change the Spectrum Analyzer setup as follows.

CENTER	the spurious frequency
SPAN	0 Hz
RES BW	30 Hz
VIDEO BW	1 Hz
SWEEP TIME	10 sec

30. Adjust A10A1R5 (API4 ADJ) until the Spectrum Analyzer displays the minimum spurious signal level and it is < -70 dBc.

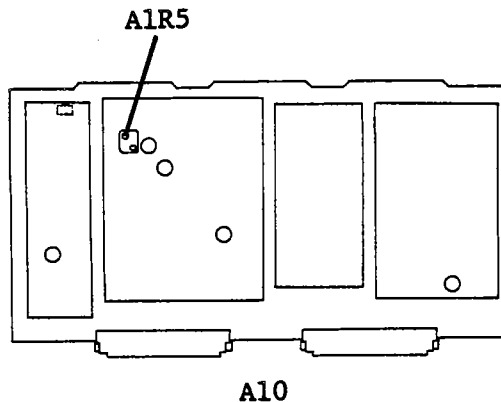

Figure 3-43. API4 Adjustment Location

3-12-3. 160 MHz SPURIOUS REJECTION ADJUSTMENT

This procedure minimizes the 160 MHz spurious signal levels in the VCO output.

NOTE

This adjustment is for the HP 4195A with A10 board PN 04195-66510 ONLY. Skip this adjustment, if your A10 board has a PN 04195-66519.

SUMMARY:

MONITOR:	J2 (LOCAL OUT) on Control Unit rear panel
ADJUSTMENT COMPONENT:	A10L204 (160 MHz NULL ADJ)
TARGET:	Minimum at 160 MHz

ADJUSTMENTS

PROCEDURE:

1. Extend the A10 board.
2. Connect the equipment as shown in Figure 3-44.

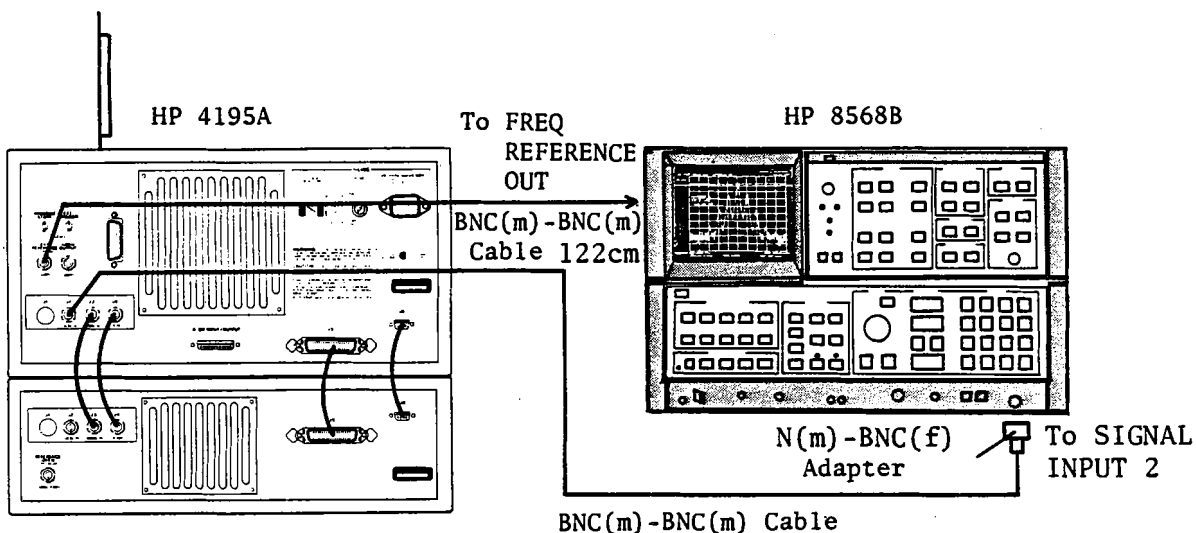

Figure 3-44. 160 MHz Spurious Rejection Adjustment Setup

3. Set up the Spectrum Analyzer as follows.

CENTER FREQUENCY	160 MHz
SPAN	0 Hz
RES BW	100 Hz
VIDEO BW	100 Hz

4. Adjust A10L204 (160MHz NULL ADJ) until the 160 MHz signal level is minimum. See Figure 3-45 for the location of A10L204.

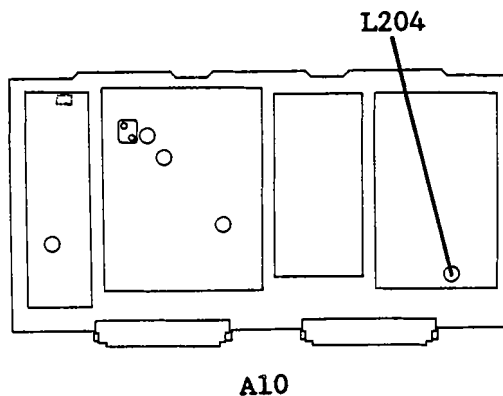

Figure 3-45. 160 MHz Spurious Rejection Adjustment Locations

3-13. REFERENCE FREQUENCY CONVERTER ADJUSTMENTS

This procedure adjusts the the 80 MHz and 160 MHz reference signal output levels, and adjusts the frequency response of the Reference Frequency Converter 160 MHz Band Pass Filter.

EQUIPMENT:

Spectrum Analyzer	HP 8568B
BNC(m)-BNC(m) Cable, 122 cm	PN 8120-1840
BNC(m)-SMB(f) Cable, 122 cm	PN 85680-60093
N(m)-BNC(f) Adapter	PN 1250-1476

3-13-1. 80 MHz REFERENCE SIGNAL LEVEL ADJUSTMENT

This procedure adjusts the 80 MHz reference signal output level.

SUMMARY:

MONITOR:	A130J1
ADJUSTMENT COMPONENT:	A130R1 (80 MHz LEVEL ADJ)
TARGET:	-10 dBm \pm 0.5 dB

PROCEDURE:

1. Connect the equipment as shown in Figure 3-46. See Figure 3-47 for the location of A130J1.

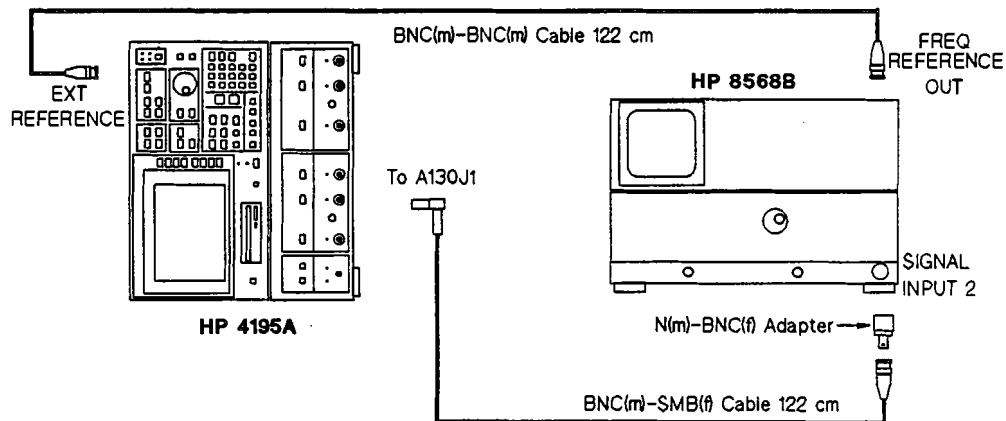

Figure 3-46. Reference Frequency Converter Adjustment Setup

ADJUSTMENTS

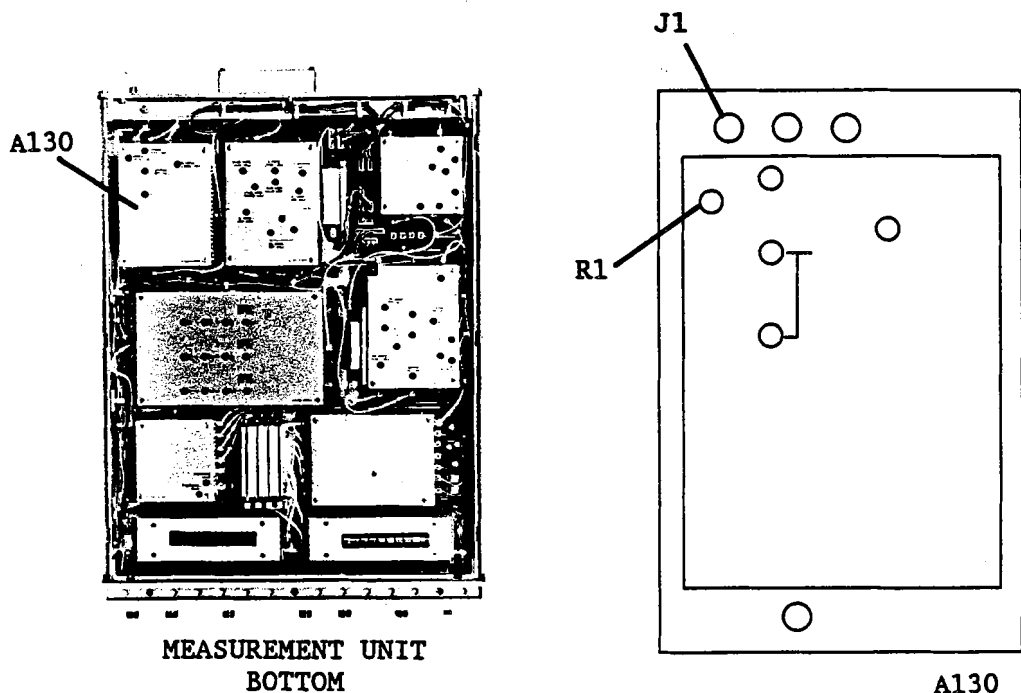

Figure 3-47. 80 MHz Reference Signal Level Adjustment Locations

2. Set up the Spectrum Analyzer as follows.

Center Frequency	80 MHz
Frequency Span	1 MHz

3. Turn the HP 4195A on.
4. Adjust **A130R1 (80 MHz LEVEL ADJ)** until the 80 MHz signal level is $-10 \text{ dBm} \pm 0.5 \text{ dB}$. See Figure 3-47 for the location of A130R1.

3-13-2. 160 MHz BAND PASS FILTER AND REFERENCE SIGNAL LEVEL ADJUSTMENTS

This procedure adjusts the reference signal converter 160 MHz bandpass filter, and its output signal level.

SUMMARY:

MONITOR:		A130J2
ADJUSTMENT COMPONENT:	A130L6, L7 (160 MHz BPF ADJ)	
	A130R2 (160MHz LEVEL ADJ)	
TARGET:	BPF ADJ	A130J2 Output Level: maximum level
	LEVEL ADJ	A130J2 Output Level: $-10 \text{ dBm} \pm 5 \text{ dB}$

PROCEDURE:

1. Connect the equipment as shown in Figure 3-46, paragraph 3-13-1. Connect the Spectrum Analyzer input cable to **A130J2** instead of A130J1. See Figure 3-48 for the location of A130J2.

ADJUSTMENTS

2. Set up the Spectrum Analyzer as follows.

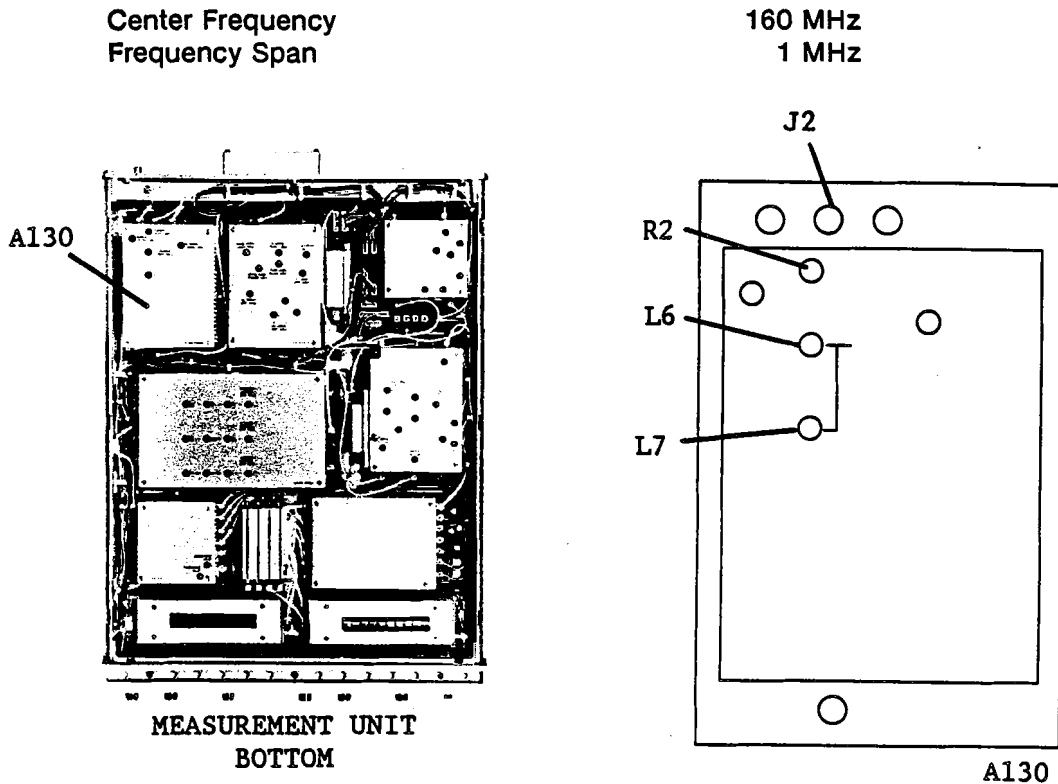

Figure 3-48. 160 MHz Band Pass Filter Adjustment Locations

3. Turn the HP 4195A on.
4. Find the fundamental signal at (or near) the center frequency on the Spectrum Analyzer display.
5. Change the Spectrum Analyzer setup as follows.

CENTER FREQUENCY	Fundamental Signal Frequency
SPAN	0 Hz
SWEEP TIME	10 sec

6. Alternately adjust A130L6 and A130L7 (160 MHz BPF ADJ) until the Spectrum Analyzer displays the maximum level.
7. Adjust A130R2 (160 MHz LEVEL ADJ) until the 160 MHz signal level is -10 dBm \pm 0.5 dB.

3-14. AC OVERLOAD DETECTOR ADJUSTMENTS

This procedure sets the AC overload detector threshold levels.

EQUIPMENT:

Signal Generator	HP 8656B
N(m)-N(m) Cable, 50 Ω, 61 cm	HP 11500B

3-14-1. LF AC OVERLOAD DETECTOR ADJUSTMENTS

This procedure sets the threshold level of the Low Frequency AC overload detector.

SUMMARY:

MONITOR: "Overload on R1 input" Message

ADJUSTMENT COMPONENT:	NETWORK	A26R78
	SPECTRUM	A26R66

TARGET:

NETWORK:

R1 Input Level= -7.0 dBm:	overload is detected
R1 Input Level= -7.2 dBm:	overload is not detected

SPECTRUM:

R1 Input Level= -15.0 dBm:	overload is detected
R1 Input Level= -15.2 dBm:	overload is not detected

PROCEDURE:

1. Position the HP 4195A on its left side as shown in Figure 3-49.
2. Remove the BNC(m)-BNC(m) cable from the rear panel J4 connectors.
3. Connect the equipment as shown in Figure 3-49.

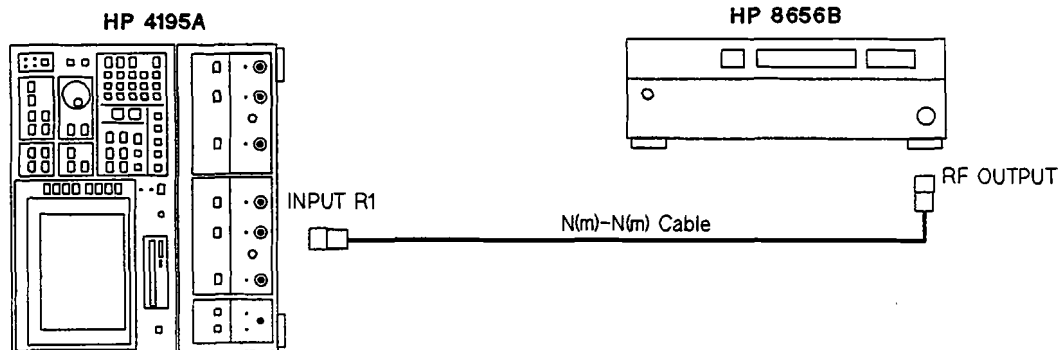

Figure 3-49. AC Overload Detector Adjustment Setup

ADJUSTMENTS

4. Set up the HP 4195A as follows.

		COMMAND
CONFIGURATION	NETWORK	FNC1
INITIALIZE	PRESET	RST
START FREQUENCY	10 Hz	START= 10
STOP FREQUENCY	200 kHz	STOP= 200 K
INPUT ATTENUATOR (R1)	0 dB	ATR1= 0

5. Set the Signal Generator frequency to 100 kHz.
6. Alternately set the signal generator output amplitude to -7.0 dBm and -7.2 dBm, and adjust A26R78 until the following conditions are satisfied.

When the signal generator output is -7.0 dBm, overload is detected.

When the signal generator output is -7.2 dBm, overload is not detected.

NOTE

The HP 4195A displays a message "Overload on R1 input" when detecting overload.

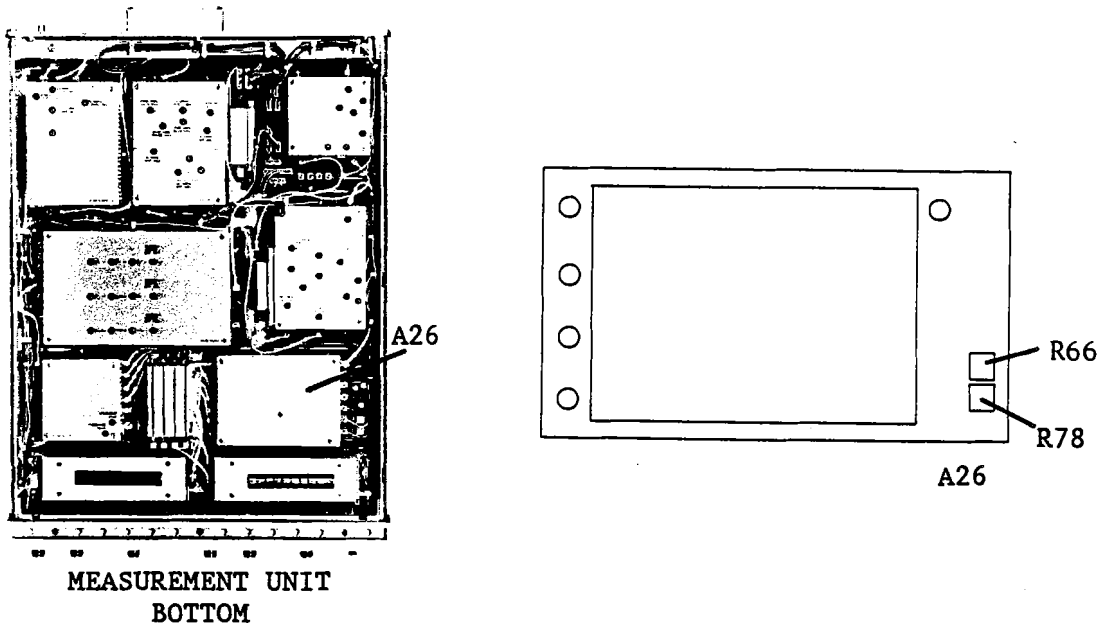

Figure 3-50. LF AC Overload Adjustment Component Locations

ADJUSTMENTS

7. Set up the HP 4195A as follows.

		COMMAND
CONFIGURATION	SPECTRUM	FNC2
INITIALIZE	PRESET	RST
START FREQUENCY	10 Hz	START= 10
STOP FREQUENCY	200 kHz	STOP= 200 K
INPUT ATTENUATOR (R1)	0 dB	ATR1= 0

8. Alternately set the signal generator output amplitude to -15.0 dBm and -15.2 dBm, and adjust **A26R66** until the following conditions are satisfied.

When the signal generator output is -15.0 dBm, overload is detected.

When the signal generator output is -15.2 dBm, overload is not detected.

3-14-2. HF AC OVERLOAD DETECTOR ADJUSTMENT

This procedure sets the threshold level of the High Frequency AC overload detector.

SUMMARY:

MONITOR:

"Overload on R1 input" Message

ADJUSTMENT COMPONENT: NETWORK
SPECTRUM

A24R48 (**OVERLOAD ADJ1**)
A24R49 (**OVERLOAD ADJ2**)

TARGET:

NETWORK:

R1 Input Level= -7.0 dBm:	overload is detected
R1 Input Level= -7.4 dBm:	overload is not detected

SPECTRUM:

R1 Input Level= -15.0 dBm:	overload is detected
R1 Input Level= -15.4 dBm:	overload is not detected

PROCEDURE:

1. Position the HP 4195A on its left side as shown in Figure 3-49, paragraph 3-14-1.
2. Disconnect the cable from the rear panel J4 connectors.
3. Connect the equipment as shown in Figure 3-49.

ADJUSTMENTS

4. Set up the HP 4195A as follows.

CONFIGURATION	NETWORK	COMMAND
INITIALIZE	PRESET	FNC1 RST
CENTER FREQUENCY	50 MHz	CENTER= 50 M
FREQUENCY SPAN	0 Hz	SPAN= 0
INPUT ATTENUATOR (R1)	0 dB	ATR1= 0

5. Set the Signal Generator frequency to 50 MHz.
6. Alternately set the signal generator output amplitude to -7.0 dBm and -7.4 dBm, and adjust **A26R48** until the following conditions are satisfied.

When the signal generator output is -7.0 dBm, overload is detected.
 When the signal generator output is -7.4 dBm, overload is not detected.

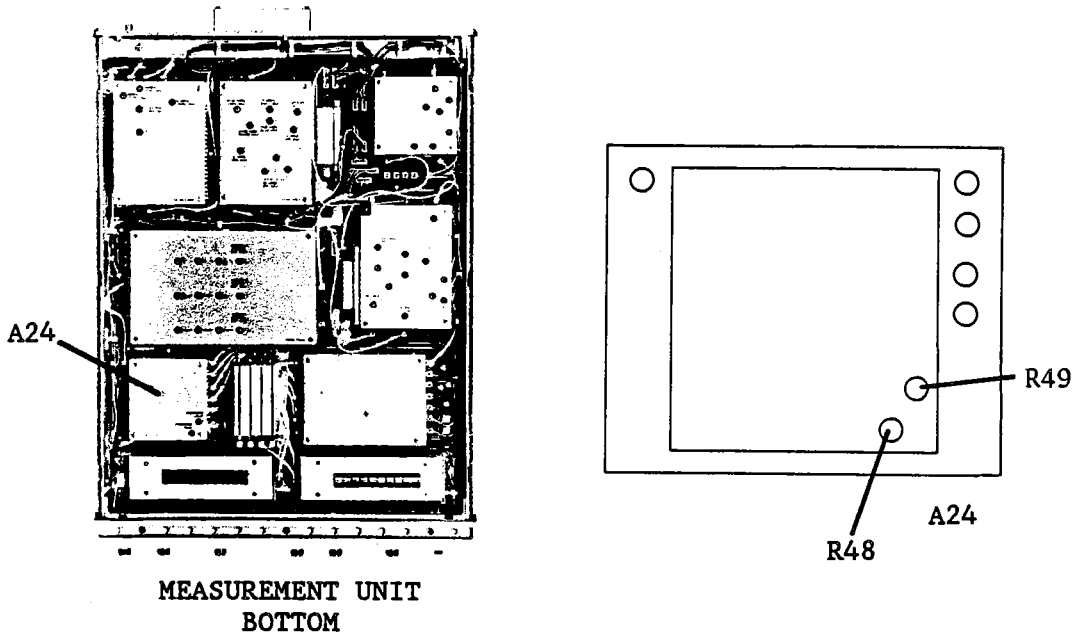

Figure 3-52. HF AC Overload Adjustment Component Locations

7. Set up the HP 4195A as follows.

CONFIGURATION	SPECTRUM	COMMAND
INITIALIZE	PRESET	FNC2 RST
CENTER FREQUENCY	50 MHz	CENTER= 50 M
FREQUENCY SPAN	0 Hz	SPAN= 0
INPUT ATTENUATOR (R1)	0 dB	ATR1= 0

8. Alternately set the signal generator output amplitude to -15.0 dBm and -15.4 dBm, and adjust **A26R49** until the following conditions are satisfied.

When the signal generator output is -15.0 dBm, overload is detected.
 When the signal generator output is -15.4 dBm, overload is not detected.

3-15. RECEIVER INPUT FILTER ADJUSTMENTS

This procedure coarse adjusts the frequency response of the three Voltage Tuned Band Pass Filters in the Receiver Input Filter.

EQUIPMENT:

Network Analyzer	HP 8753A	
Power Splitter	HP 11667A	
N(m)-N(m) Cable, 61 cm	HP 11500B	
BNC(m)-SMB(f) Cable, 122 cm	PN 85680-60093	2ea.
N(m)-N(m) Adapter	PN 1250-1475	
N(m)-BNC(f) Adapter	PN 1250-1476	2ea.
SMB(m)-SMB(m) Adapter	PN 1250-0813	

3-15-1. 150 MHz - 225 MHz VOLTAGE TUNED BPF ADJUSTMENT

SUMMARY:

ADJUSTMENT COMPONENT: A23L20, L21, L22, L23 (150 MHz - 225 MHz BPF ADJ)

TARGET: Gain at the maximum point: > -3 dB
 -0.3 dB Bandwidth: ≥ 1 MHz

PROCEDURE:

1. Connect the equipment as shown in Figure 3-53.

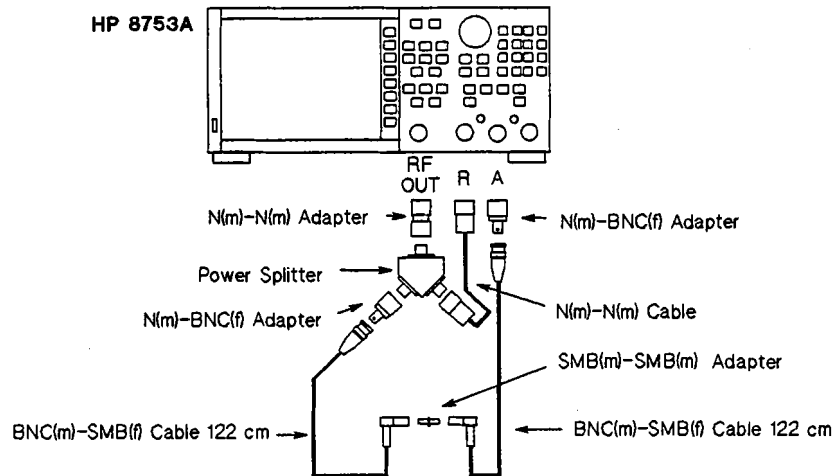

Figure 3-53. Receiver Input Filter Adjustment Network Analyzer Setup

2. Press the HP 8753A **PRESET** key.
3. Press the **MKR**, **'MARKER 1'**, **MKR FCTN**, **'MKR SEARCH [OFF]'**, **'TRACKING OFF'** (to ON), and **'MAX'** keys.
4. Press the **MKR**, **'Δ MODE MENU'**, **'Δ REF = 1'**, **MKR FCTN**, **'MKR SEARCH [MAX]'**, **'WIDTH VALUE'**, - (minus), . (period), **3**, **x1**, and **'WIDTHS OFF'** (to ON) keys.

ADJUSTMENTS

5. Press the **SCALE REF**, **5**, **x1**, **'REFERENCE VALUE'**, **-**, **1**, **0**, **x1** keys.
6. Set the **CENTER** frequency and the frequency **SPAN** to 150 MHz and 10 MHz, respectively. Press the **CAL**, **'CALIBRATE MENU'**, **'RESPONSE'**, **'THRU'**, **'DONE: RESPONSE'**, and **'SAVE REG1'** (or **'RE-SAVE REG1'**) keys.
7. Change the **CENTER** frequency to 225 MHz. Press the **CAL**, **'CALIBRATE MENU'**, **'RESPONSE'**, **'THRU'**, **'DONE: RESPONSE'**, and **'SAVE REG2'** (or **'RE-SAVE REG2'**) keys.
8. Change the **CENTER** frequency to 180 MHz. Press the **CAL**, **'CALIBRATE MENU'**, **'RESPONSE'**, **'THRU'**, **'DONE: RESPONSE'**, and **'SAVE REG3'** (or **'RE-SAVE REG3'**) keys.
9. Connect the equipment as shown in Figure 3-54. See Figure 3-55 for A23J1 and J2 locations.

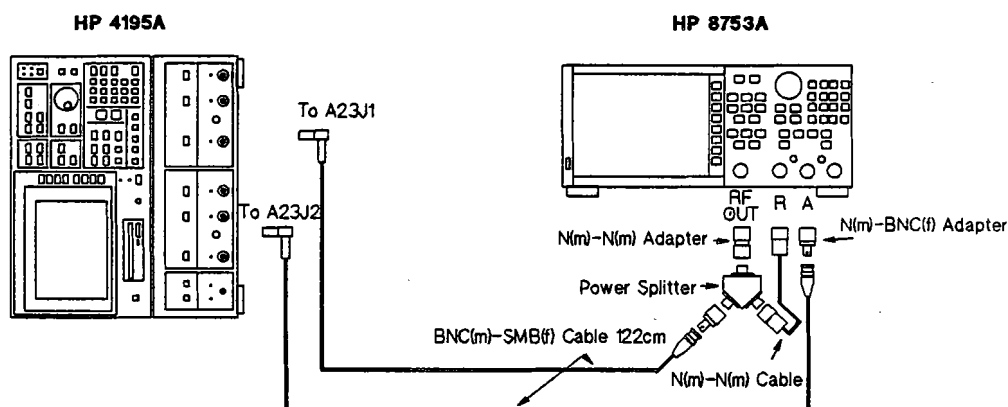

Figure 3-54. Receiver Input Filter Adjustment Setup

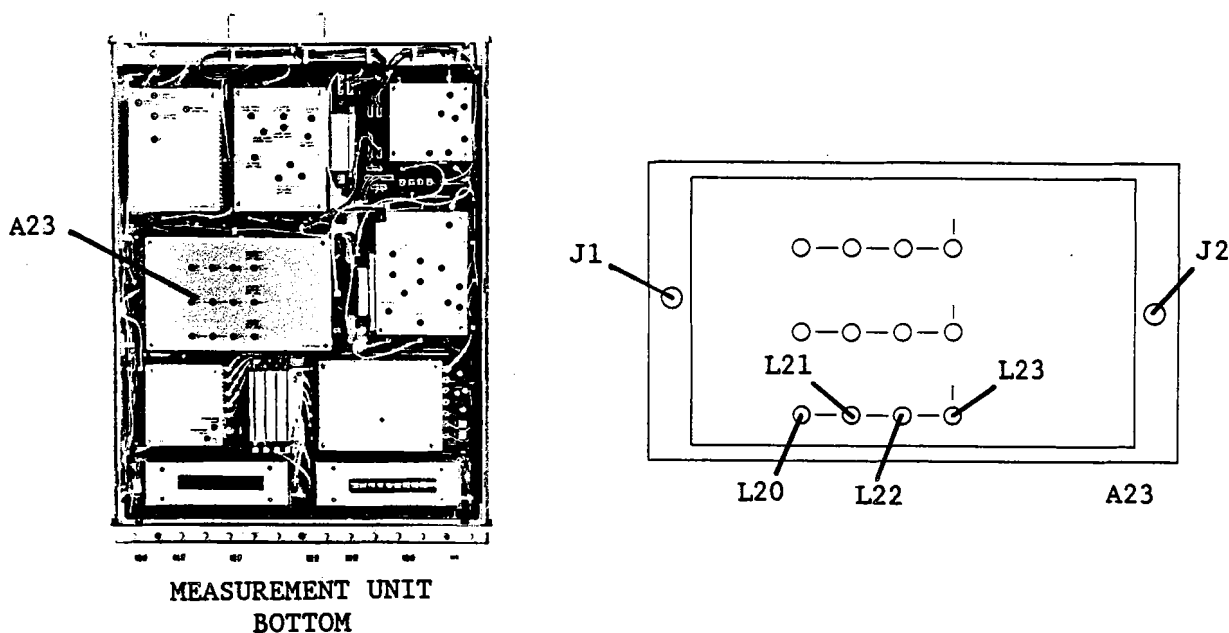

Figure 3-55. 150-225 MHz Voltage Tuned BPF Adjustment Locations

10. Turn the HP 4195A on.

ADJUSTMENTS

10. Turn the HP 4195A on.
11. Enter the "STSET" command using the following key strokes, to display the Service Function Menu.

Blue shiftkey, S, T, S, E, T, ENTER/EXECUTE key

12. Enter the "STN=50" command using the following key strokes, to enter the Service Function No. 50 mode.

'TEST No.' softkey ,5, 0, ENTER/EXECUTE key

13. Press the 'START' softkey, and set its (display) FILTER to LOW, by repeatedly pressing the 'FILTER select' softkey.
14. Press the HP 8753A RECALL, and 'RECALL REG 1' keys.
15. Set the DAC data value to 3 using the following key strokes.

'DAC data' softkey, 3, ENTER/EXECUTE key

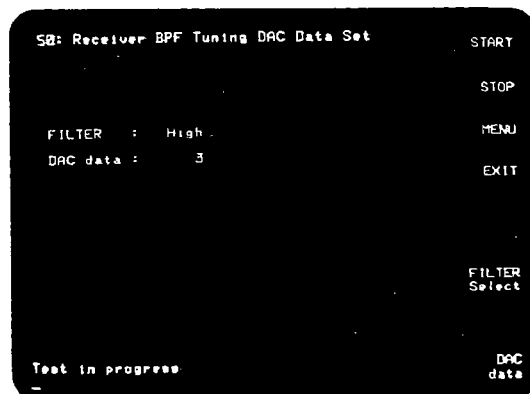

Figure 3-56. Service Function No. 50 Display Example

16. Adjust A23L20, L21, L22, and L23 (150 MHz-225 MHz BPF ADJ), until the following conditions are satisfied.
 - a. Center Frequency of -0.3 dB Pass Band: 150 MHz to 151 MHz
 - b. -0.3 dB Bandwidth: ≥ 1 MHz
 - c. Gain at the maximum point: > -3 dB

NOTE

To measure gain for condition *c*, press the MKR, 'Δ MODE MENU', and 'Δ MODE OFF' keys of HP 8753A. To return measuring the conditions *a* and *b*, press the 'Δ MODE MENU', and 'Δ REF = 1' keys.

ADJUSTMENTS

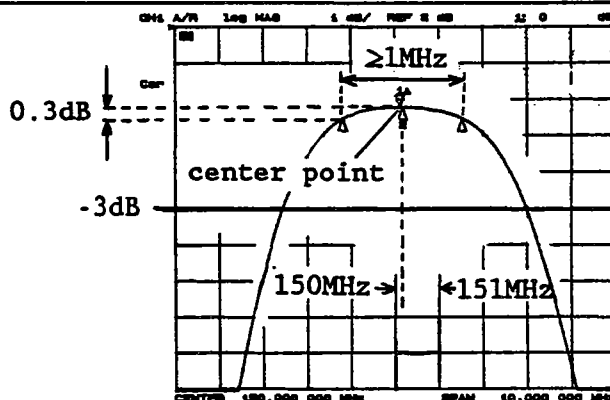

Figure 3-57. 150 - 225 MHz Voltage Tuned BPF Adjustment Example

17. Press the **RECALL**, and '**RECALL REG 2**' keys.
18. Set the **DAC data** value to 200, using the following key strokes.
 'DAC data' softkey, 2, 0, 0, **ENTER/EXECUTE** key
19. Vary the **DAC data** value until the center frequency of the BPF characteristics displayed by the Network Analyzer is approximately 225 MHz.
20. Adjust **A23L20**, **L21**, **L22**, and **L23** until the following conditions are satisfied.

a. -0.3 dB Bandwidth:	≥ 1 MHz
b. Gain at the maximum point:	> -3 dB
21. Press the HP 8753A **RECALL**, and '**RECALL REG 3**' keys.
22. Set the **DAC data** value to 50 using the following key strokes.
 'DAC data' softkey, 5, 0, **ENTER/EXECUTE** key
23. Vary the **DAC data** until the center frequency of the BPF characteristics displayed by the Network Analyzer is approximately 180 MHz.
24. Adjust **A23L20**, **L21**, **L22**, and **L23** until the following conditions are satisfied.

a. -0.3 dB Bandwidth:	≥ 1 MHz
b. Gain at the maximum point:	> -3 dB
25. Repeat steps 14 through 24, until all conditions of steps 16, 20, and 24 are satisfied without having to make further adjustments of **A23L20**, **L21**, **L22**, and **L23**.

3-15-2. 225 MHz - 340 MHz VOLTAGE TUNED BPF ADJUSTMENT

SUMMARY:

ADJUSTMENT COMPONENT: A23L3, L5, L7, L11 (225 MHz - 340 MHz BPF ADJ)

TARGET:	Gain at the maximum point:	> -3 dB
	-0.3 dB Bandwidth:	≥ 1.5 MHz

PROCEDURE:

ADJUSTMENTS

1. Connect the equipment as shown in Figure 3-53.
2. Press the **PRESET** key.
3. Press the **MKR**, '**MARKER 1**', **MKR FCTN**, '**MKR SEARCH [OFF]**', '**TRACKING OFF**' (to ON), and '**MAX**' keys.
4. Press the **MKR**, '**Δ MODE MENU**', '**Δ REF = 1**', **MKR FCTN**, '**MKR SEARCH [MAX]**', '**WIDTH VALUE**', - (minus), . (period), 3, x1, and '**WIDTHS OFF**' (to ON) keys.
5. Press the **SCALE REF**, 5, x1, '**REFERENCE VALUE**', -, 1, 0, x1 keys.
6. Set the **CENTER** frequency and the frequency **SPAN** to 225 MHz and 20 MHz, respectively. Press the **CAL**, '**CALIBRATE MENU**', '**RESPONSE**', '**THRU**', '**DONE: RESPONSE**', and '**SAVE REG1**' (or '**RE-SAVE REG1**') keys.
7. Change **CENTER** frequency to 340 MHz. Press the **CAL**, '**CALIBRATE MENU**', '**RESPONSE**', '**THRU**', '**DONE: RESPONSE**', and '**SAVE REG2**' (or '**RE-SAVE REG2**') keys.
8. Change the **CENTER** frequency to 285 MHz. Press the **CAL**, '**CALIBRATE MENU**', '**RESPONSE**', '**THRU**', '**DONE: RESPONSE**', and '**SAVE REG3**' (or '**RE-SAVE REG3**') keys.
9. Connect the equipment as shown in Figure 3-54. See Figure 3-58 for A23J1 and J2 locations.

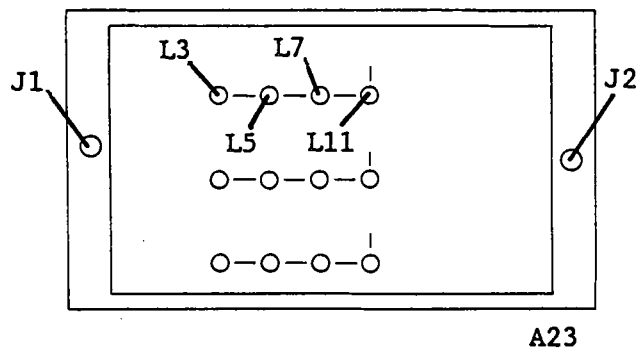

Figure 3-58. 225-340 MHz Voltage Tuned BPF Adjustment Locations

10. Turn the HP 4195A on.
11. Enter the "**STSET**" command using the following key strokes, to display the Service Function Menu.
Blue shiftkey, S, T, S, E, T, ENTER/EXECUTE key
12. Enter the "**STN=50**" command using the following key strokes, to enter the Service Function No. 50 mode.
'TEST No.' softkey, 5, 0, ENTER/EXECUTE key
13. Press the '**START**' softkey, and set its (display) **FILTER** to **MID**, by repeatedly pressing the '**FILTER select**' softkey.
14. Press the HP 8753A **RECALL**, and '**RECALL REG 1**' keys.

ADJUSTMENTS

15. Set the DAC data value to 3 using the following key strokes.

‘DAC data’ softkey, 3, ENTER/EXECUTE key

16. Adjust A23L3, L5, L7, and L11 (225 MHz-340 MHz BPF ADJ), until the following conditions are satisfied.

- | | |
|---|--------------------|
| a. Center Frequency of -0.3 dB Pass Band: | 225 MHz to 226 MHz |
| b. -0.3 dB Bandwidth: | ≥ 1.5 MHz |
| c. Gain at the maximum point: | > -3 dB |

NOTE

To measure gain for condition *c*, press the MKR, ‘ Δ MODE MENU’ and ‘ Δ MODE OFF’ keys of HP 8753A. To return measuring the conditions *a* and *b*, press the ‘ Δ MODE MENU’, and ‘ Δ REF = 1’ keys.

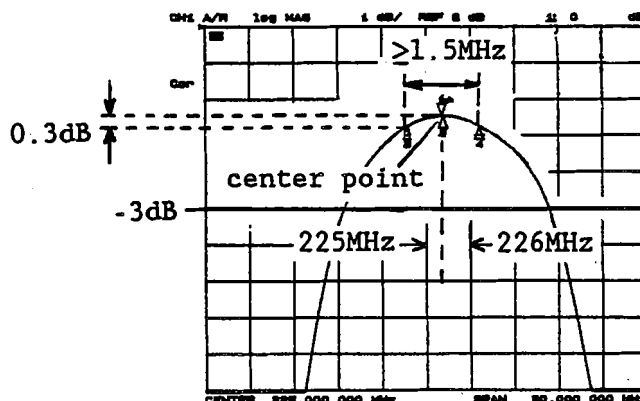

Figure 3-59. 225 - 340 MHz Voltage Tuned BPF Adjustment Example

17. Press the RECALL, and ‘RECALL REG 2’ keys.

18. Set the DAC data value to 200, using the following key strokes.

‘DAC data’ softkey, 2, 0, 0, ENTER/EXECUTE key

19. Vary the DAC data value until the center frequency of the BPF characteristics displayed by the Network Analyzer is approximately 340 MHz.

20. Adjust A23L3, L5, L7, and L11 until the following conditions are satisfied.

- | | |
|-------------------------------|----------------|
| a. -0.3 dB Bandwidth: | ≥ 1.5 MHz |
| b. Gain at the maximum point: | > -3 dB |

21. Press the HP 8753A RECALL, and ‘RECALL REG 3’ keys.

22. Set the DAC data value to 50 using the following key strokes.

‘DAC data’ softkey, 5, 0, ENTER/EXECUTE key

23. Vary the DAC data until the center frequency of the BPF characteristics displayed by the Network Analyzer is approximately 285 MHz.

24. Adjust A23L3, L5, L7, and L11 until the following conditions are satisfied.

ADJUSTMENTS

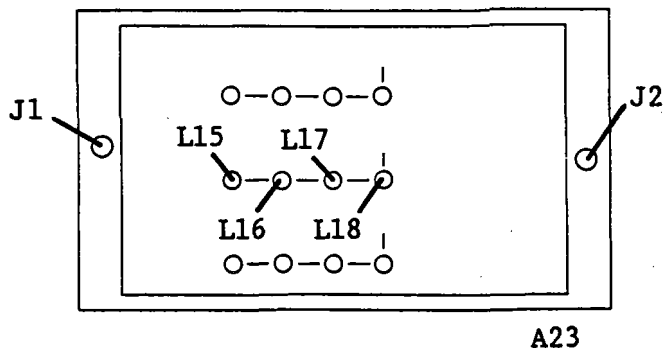

Figure 3-60. 340-500 MHz Voltage Tuned BPF Adjustment Locations

10. Turn the HP 4195A on.
11. Enter the "STSET" command using the following key strokes, to display the Service Function Menu.

Blue shiftkey, S, T, S, E, T, ENTER/EXECUTE key
12. Enter the "STN=50" command using the following key strokes, to enter the Service Function No. 50 mode.

'TEST No.' softkey, 5, 0, ENTER/EXECUTE key
13. Press the 'START' softkey, and set its (display) FILTER to **HIGH**, by repeatedly pressing the 'FILTER select' softkey.
14. Press the HP 8753A **RECALL**, and 'RECALL REG 1' keys.
15. Set the **DAC data** value to 3 using the following key strokes.

'DAC data' softkey, 3, ENTER/EXECUTE key
16. Adjust A23L15, L16, L17, and L18 (340 MHz-500 MHz BPF ADJ), until the following conditions are satisfied.

a. Center Frequency of -0.3 dB Pass Band:	340 MHz to 341 MHz
b. -0.3 dB Bandwidth:	≥ 2 MHz
c. Gain at the maximum point:	> -3 dB

NOTE

To measure gain for condition *c*, press the MKR, 'Δ MODE MENU' and 'Δ MODE OFF' keys of HP 8753A. To return measuring the conditions *a* and *b*, press the 'Δ MODE MENU', and 'Δ REF = 1' keys.

ADJUSTMENTS

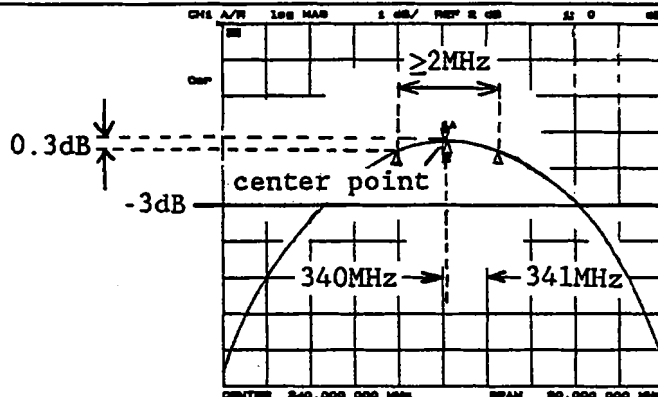

Figure 3-61. 340 - 500 MHz Voltage Tuned BPF Adjustment Example

17. Press the **RECALL**, and '**RECALL REG 2**' keys.
18. Set the **DAC data** value to 200, using the following key strokes.

'DAC data' softkey, **2, 0, 0, ENTER/EXECUTE** key
19. Vary the **DAC data** value until the center frequency of the BPF characteristics displayed by the Network Analyzer is approximately 500 MHz.
20. Adjust **A23L15, L16, L17, and L18** until the following conditions are satisfied.
 - a. -0.3 dB Bandwidth: ≥ 2 MHz
 - b. Gain at the maximum point: > -3 dB
21. Press the HP 8753A **RECALL**, and '**RECALL REG 3**' keys.
22. Set the **DAC data** value to 50 using the following key strokes.

'DAC data' softkey, **5, 0, ENTER/EXECUTE** key
23. Vary the **DAC data** until the center frequency of the BPF characteristics displayed by the Network Analyzer is approximately 420 MHz.
24. Adjust **A23L15, L16, L17, and L18** until the following conditions are satisfied.
 - a. -0.3 dB Bandwidth: ≥ 2 MHz
 - b. Gain at the maximum point: > -3 dB
25. Repeat steps 14 through 24, until all conditions of steps 16, 20, and 24 are satisfied without having to make further adjustment of **A23L15, L16, L17, and L18**.

3-16. RECEIVER FIRST IF CONVERTER ADJUSTMENTS

This procedure adjusts the 86.6 MHz Band Pass Filter, 246 MHz Band Pass Filter, 86.6 MHz output level, 246 MHz output level, and minimizes the local OSC leakage from the Receiver First IF Converter.

3-16-1. FIRST IF CONVERTER 86.6 MHz BPF ADJUSTMENT

This procedure adjusts the 86.6 MHz Band Pass Filter of the first IF converter.

EQUIPMENT:

Network Analyzer	HP 8753A	
Signal Generator	HP 8656B	
Power Splitter	HP 11667A	
Mixer	HP 10514A	
3 dB Pad	HP 8491A Option 003	3 ea.
N(m)-N(m) Cable, 61 cm	HP 11500B	3 ea.
BNC(m)-BNC(m) Cable, 122 cm	PN 8120-1840	2 ea.
BNC(m)-SMB(f) Cable, 122 cm	PN 85680-60093	2 ea.
N(m)-BNC(f) Adapter	PN 1250-1476	2 ea.
N(m)-N(m) Adapter	PN 1250-1475	
N(f)-BNC(m) Adapter	PN 1250-1477	3 ea.
Right Angle BNC Adapter	PN 1250-0076	
BNC(f)-SMB(f) Adapter	PN 1250-1236	2 ea.

SUMMARY:

ADJUSTMENT COMPONENT: A22L2, L6, L7, L9 (86.6 MHz BPF ADJ)

TARGET: -3 dB Bandwidth: 3 MHz to 6 MHz
Ripple within ± 150 kHz of Center Frequency: 0.1 dB
Position of the maximum point: 150 MHz ± 25 kHz

PROCEDURE:

1. Connect the equipment as shown in Figure 3-62. See Figure 3-63 for A22J1 and J4 locations.

ADJUSTMENTS

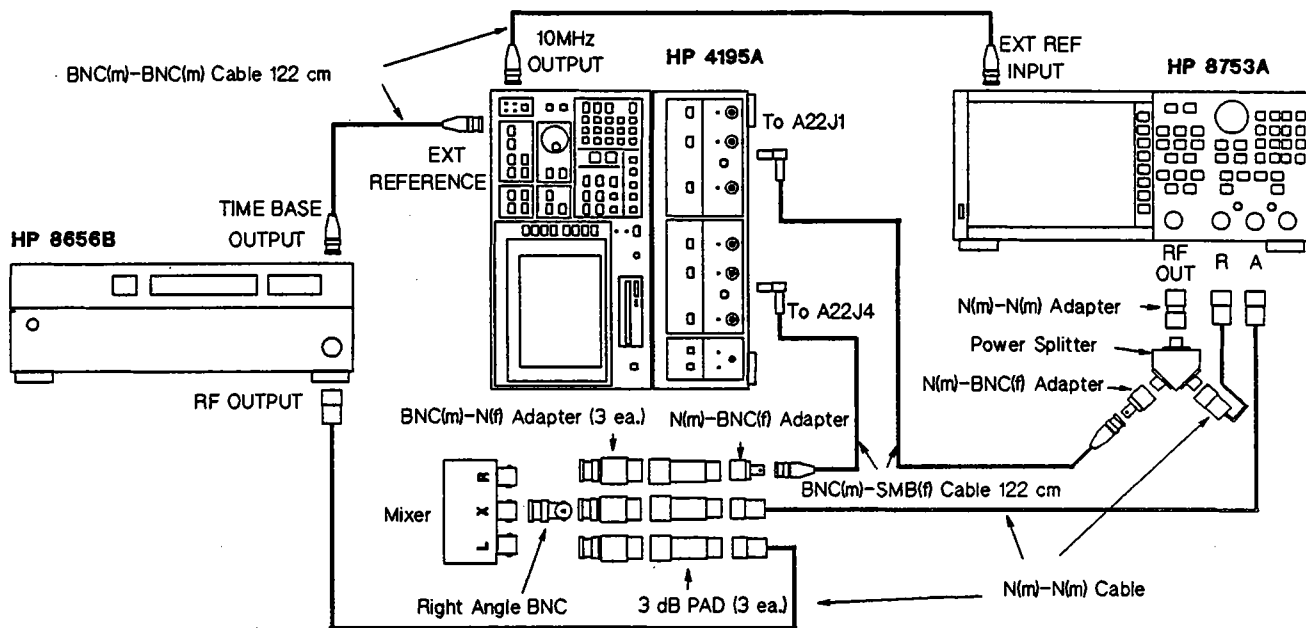

Figure 3-62. Receiver First IF Converter BPF Adjustment Setup

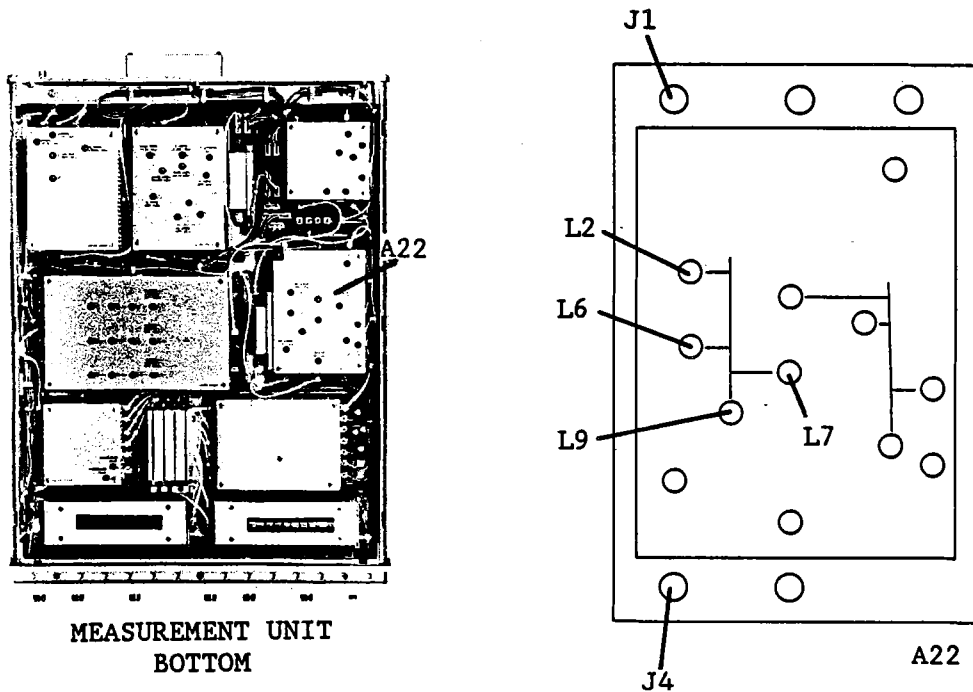

Figure 3-63. Receiver First IF Converter 86.6 MHz BPF Adjustment Locations

2. Set up the HP 4195A as follows.

CONFIGURATION
INITIALIZE
CENTER FREQUENCY
FREQUENCY SPAN
TRIGGER MODE

SPECTRUM
PRESET
150 MHz
0 Hz
external

COMMAND

FNC2
RST
CENTER= 150 M
SPAN= 0
TRGM2

3. Set up the Signal Generator as follows.

ADJUSTMENTS

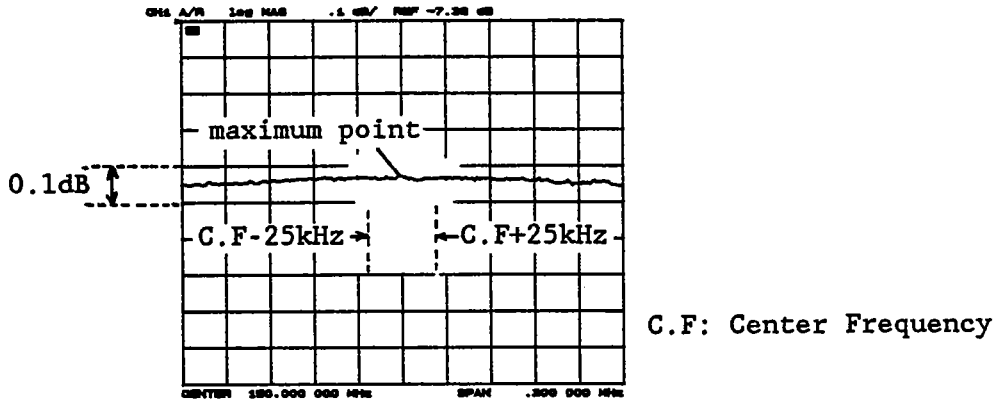

Figure 3-65. Receiver First IF Converter 86.6 MHz BPF Adjustment Example 2

9. Repeat steps 4 through 8 until the both conditions in steps 5 and 8 are satisfied.

3-16-2. FIRST IF CONVERTER 246 MHz BPF ADJUSTMENT

This procedure adjusts the 246 MHz Band Pass Filter of the first IF converter.

SUMMARY:

ADJUSTMENT COMPONENT:	A22L3, L5, L8, L10 (246 MHz BPF ADJ)	
TARGET:	-3 dB Bandwidth:	8 MHz to 14 MHz
	Ripple at ± 150 kHz for Center Frequency:	0.1 dB
	Position of the maximum point:	150 MHz ± 25 kHz

PROCEDURE:

1. Connect the equipment as shown in Figure 3-61. Connect Mixer R INPUT cable to A22J5 instead of A22J4. See Figure 3-66 for the locations of A22J1 and A22J5.

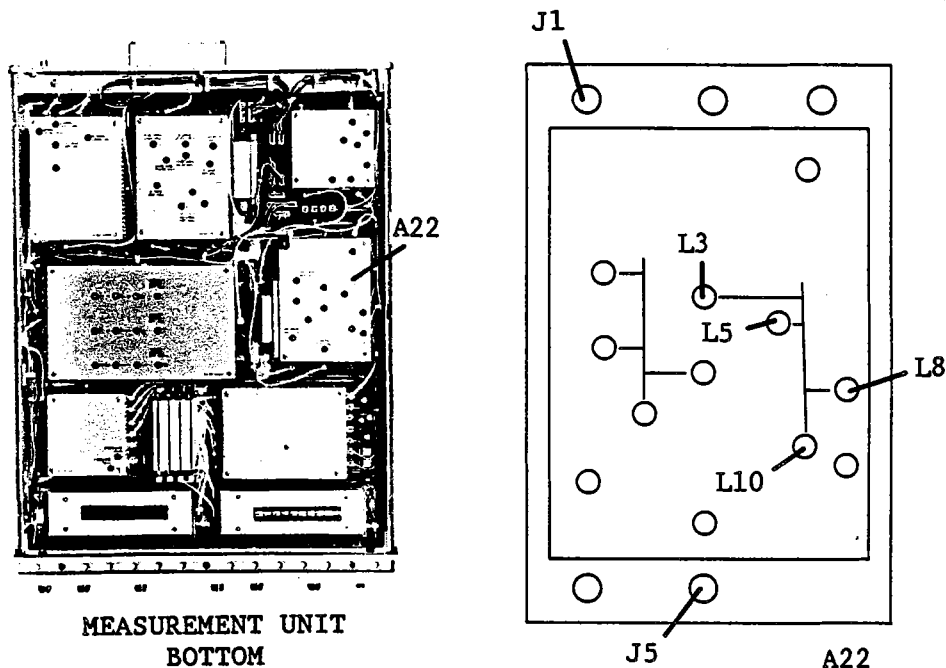

Figure 3-66. Receiver First IF Converter 246 MHz BPF Adjustment Locations

2. Set up the HP 4195A as follows.

COMMAND

CONFIGURATION	SPECTRUM	FNC2
INITIALIZE	PRESET	RST
CENTER FREQUENCY	149.999 999 999 MHz	CENTER=149.999999999M
FREQUENCY SPAN	0 Hz	SPAN= 0
TRIGGER MODE	external	TRGM2

3. Set up the Signal Generator as follows.

Output Frequency	396.66666 MHz
Output Level	13 dBm

4. Set up the Network Analyzer as follows.

Center Frequency	150 MHz
Frequency Span	20 MHz
Output Level	-10 dBm

5. Adjust A22L3, L5, L8 and L10 (246 MHz BPF ADJ) until the Network Analyzer displays a trace similar to that shown in Figure 3-67. The following are the conditions of the target trace.
 - a. No peak higher than the peak at the center frequency exists.
 - b. Center frequency should be as close as possible to 150 MHz.
 - c. -3 dB bandwidth should be 8 MHz to 14 MHz.

ADJUSTMENTS

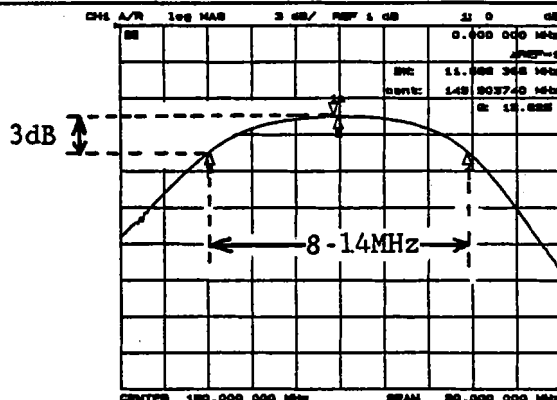
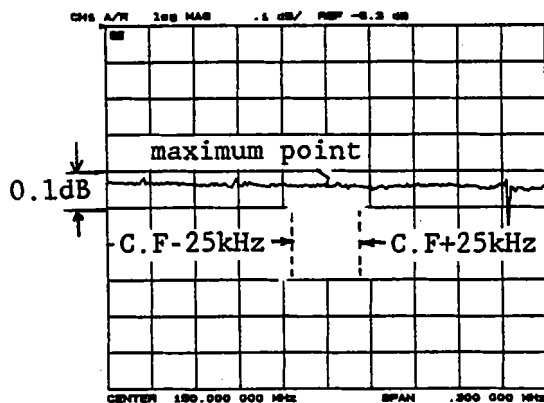

Figure 3-67. Receiver First IF Converter 246.6 MHz BPF Adjustment Example 1

6. Change the Network Analyzer Frequency SPAN to 300 kHz.
7. Press the Network Analyzer 'SCALE REF', ., 1, x1 keys to set the SCALE/DIV to 0.1 dB/div.
8. Adjust A22L3, L5, L8, and L10 (246 MHz BPF ADJ) until the ripple in the range displayed by the Network Analyzer is less than 0.1 dB, and a maximum point is positioned at 150 MHz \pm 25 kHz as shown in Figure 3-68.

NOTE

Ignore any spikes that may appear on the trace caused by mixer distortion.



C.F: Center Frequency

Figure 3-68. Receiver First IF Converter 246.6 MHz BPF Adjustment Example 2

9. Repeat steps 4 through 8 until the conditions in steps 5 and 8 are satisfied.

3-16-3. FIRST IF CONVERTER 86.6 MHz LEVEL ADJUSTMENT

This procedure adjusts the receiver first IF converter 86.6 MHz output level. Before performing this adjustment, complete the First IF Converter 86.6 MHz BPF Adjustment, described in paragraph 3-16-1.

EQUIPMENT:

Spectrum Analyzer
Signal Generator

HP 8568B
HP 8656B

ADJUSTMENTS

BNC(m)-BNC(m) Cable, 122 cm
 BNC(m)-SMB(f) Cable, 122 cm
 N(m)-BNC(f) Adapter

PN 8120-1840	2 ea.
PN 85680-60093	2 ea.
PN 1250-1476	2 ea.

SUMMARY:

MONITOR:	A22J4
ADJUSTMENT COMPONENT:	A22R47 (86.6 MHz LEVEL ADJ)
TARGET:	A22J4 Output Level: -14 dBm ±0.5 dB

PROCEDURE:

1. Connect the equipment as shown in Figure 3-69. See Figure 3-70 for A22J1 and A22J4 locations.

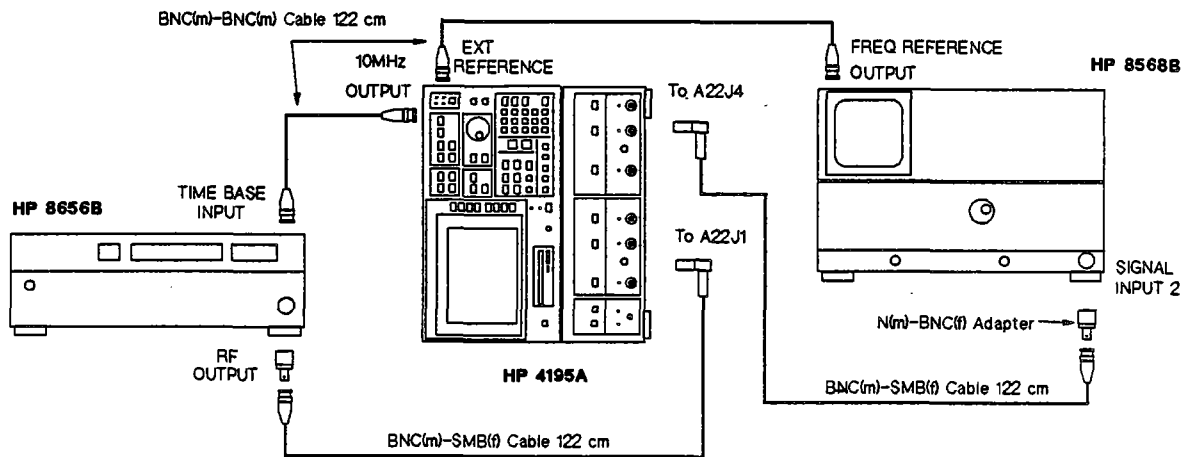

Figure 3-69. Receiver First IF Converter Level Adjustment Setup

ADJUSTMENTS

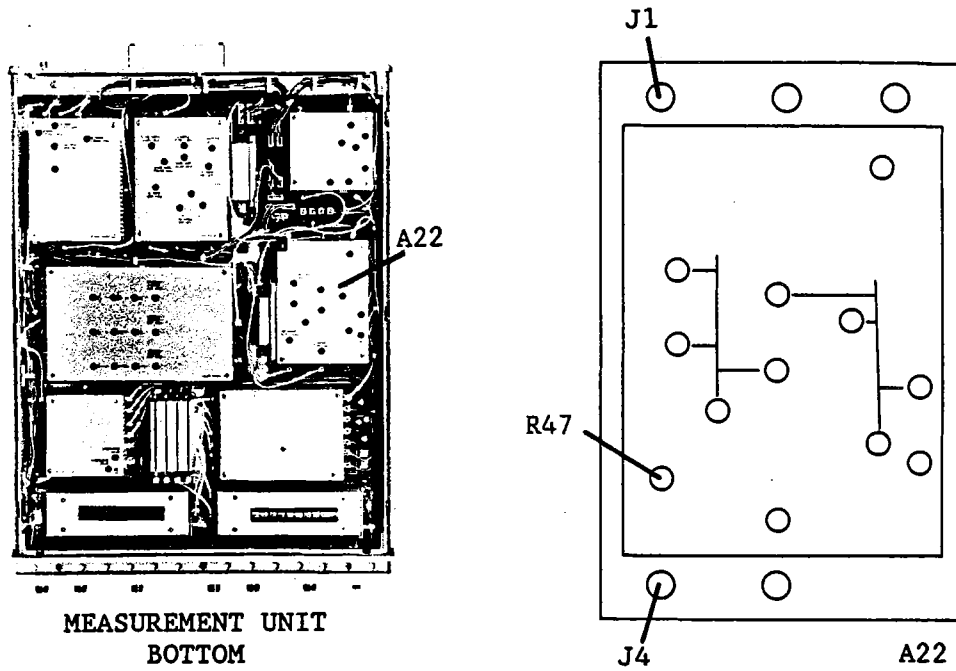

Figure 3-70. Receiver First IF Converter 86.6 MHz Level Adjustment Locations

2. Set up the Signal Generator as follows.

Output Frequency	150 MHz
Output Level	-20 dBm

3. Set up the Spectrum Analyzer as follows.

Center Frequency	86.667 MHz
Frequency Span	1 MHz

4. Set up the HP 4195A as follows.

		COMMAND
CONFIGURATION	SPECTRUM	FNC2
INITIALIZE	PRESET	RST
CENTER FREQUENCY	150 MHz	CENTER= 150 M
FREQUENCY SPAN	0 Hz	SPAN= 0
TRIGGER MODE	External	TRGM2

5. Adjust A22R47 (86.6 MHz LEVEL ADJ) until the peak level displayed by the Spectrum Analyzer is -14 dBm \pm 0.5 dB.

NOTE

If you are unable to adjust the level as specified, adjust the 86.6 MHz BPF as described in the section 3-16-1.

3-16-4. FIRST IF CONVERTER 246 MHz LEVEL ADJUSTMENT

This procedure adjusts the 246.6 MHz output level of the receiver first IF converter. Before performing this adjustment, complete the First IF Converter 246 MHz BPF Adjustment, described in paragraph 3-16-2.

ADJUSTMENTS

SUMMARY:

MONITORING POINT: A22J5

ADJUSTMENT COMPONENT: A22R52 (246.6 MHz LEVEL ADJ)

TARGET: A22J5 Output Level: -14 dBm \pm 0.5 dB

PROCEDURE:

1. Connect the equipment as shown in Figure 3-69. See Figure 3-71 for A22J1 and A22J5 locations.

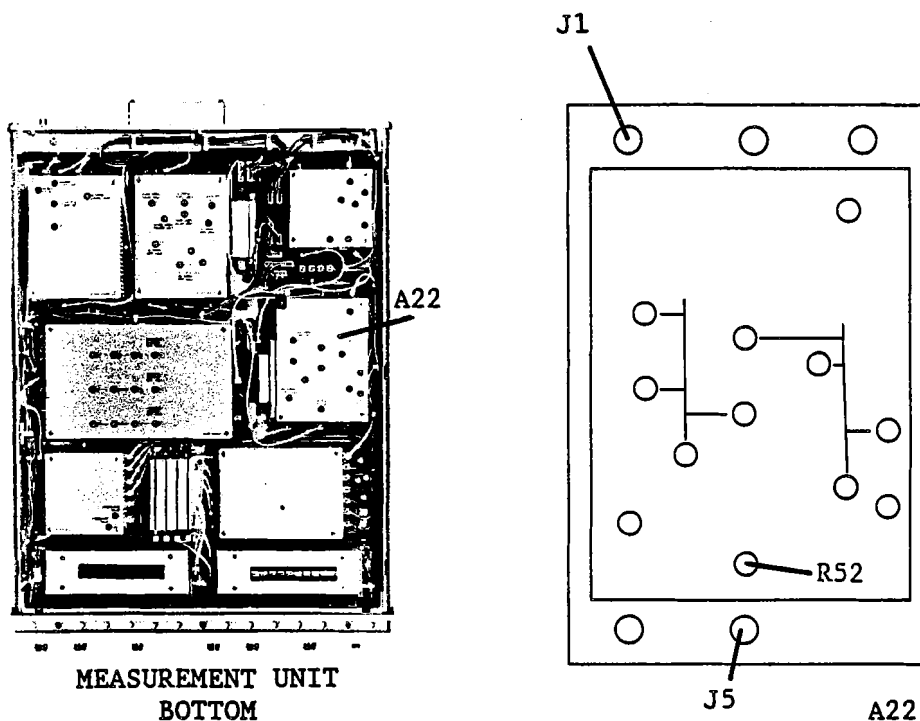

Figure 3-71. First IF Converter 86.6 MHz Level Adjustment Locations

2. Set up the Signal Generator as follows.

Output Frequency	150 MHz
Output Level	-20 dBm

3. Set up the Spectrum Analyzer as follows.

Center Frequency	246.667 MHz
Frequency Span	1 MHz

4. Set up the HP 4195A as follows.

COMMAND

CONFIGURATION	SPECTRUM	FNC2
INITIALIZE	PRESET	RST
CENTER FREQUENCY	149.999 999 MHz	CENTER= 149.999 999 M

ADJUSTMENTS

- Set up the HP 4195A as follows.

CONFIGURATION	SPECTRUM	COMMAND
INITIALIZE	PRESET	FNC2
STOP FREQUENCY	0.001 Hz	RST
RBW	300 kHz	STOP= 0.001
INPUT ATTENUATOR (R1)	0 dB	RBW= 300 K
IF RANGE	NORMAL	ATR1= 0
		IRNG1

- Alternately adjust **A22C52** and **A22R59** until the displayed data **A (MAG)** is minimum and < -55 dBm.

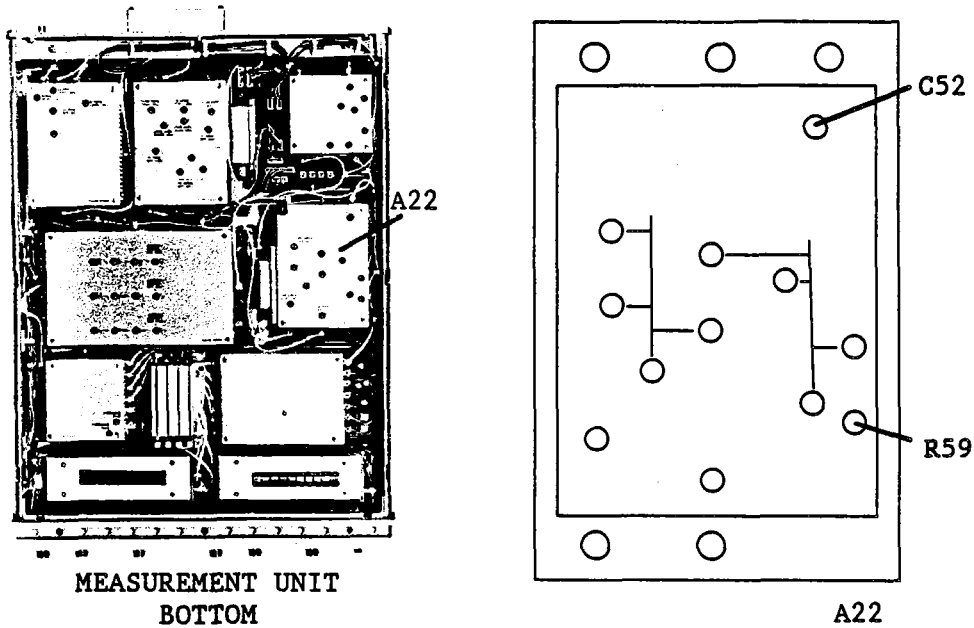

Figure 3-73. Receiver First IF Converter Local OSC Leakage Adjustment Locations

- Change the IF RANGE to the Low Distortion mode by pressing the 'IF RNG Lo DISTN' key, then check that the displayed data is < -55 dBm.
- Change the IF RANGE to the High Sensitivity mode by pressing the 'IF RNG Hi SENS' key, then check that the displayed data is < -55 dBm.

3-17. RECEIVER SECOND IF CONVERTER ADJUSTMENTS

This procedure adjusts the frequency response of the 246 MHz and 86.6 MHz Band Pass Filters and the Receiver Second IF Converter output level.

3-17-1. SECOND IF CONVERTER 246 MHz BPF ADJUSTMENT

This procedure adjusts the Receiver Second IF Converter 246 MHz Band Pass Filter.

EQUIPMENT:

Network Analyzer	HP 8753A	
Power Splitter	HP 11667A	
Resistive Divider Probe	HP 10020A	
N(m)-N(m) Cable, 61 cm	HP 11500B	
N(m)-BNC(f) Adapter	PN 1250-1476	2 ea.
BNC(m)-SMB(f) Cable, 122 cm	PN 85680-60093	
N(m)-N(m) Adapter	PN 1250-1475	

SUMMARY:

ADJUSTMENT COMPONENT: A21L9, L10, L11 (246 MHz BPF ADJ)

TARGET: Ripple within ± 150 kHz of Center Frequency: 0.1 dB
 Position of maximum point: Center Frequency ± 25 kHz

PROCEDURE:

1. Connect the equipment as shown in Figure 3-74 and 3-75.

NOTE

Do not turn the HP 4195A on during this adjustment.

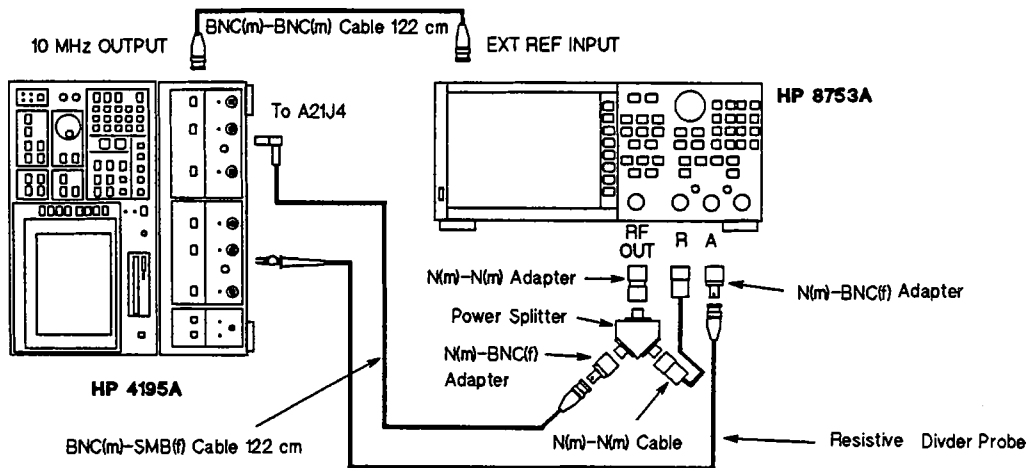

Figure 3-74. Receiver Second IF Converter 246 MHz BPF Adjustment Setup

ADJUSTMENTS

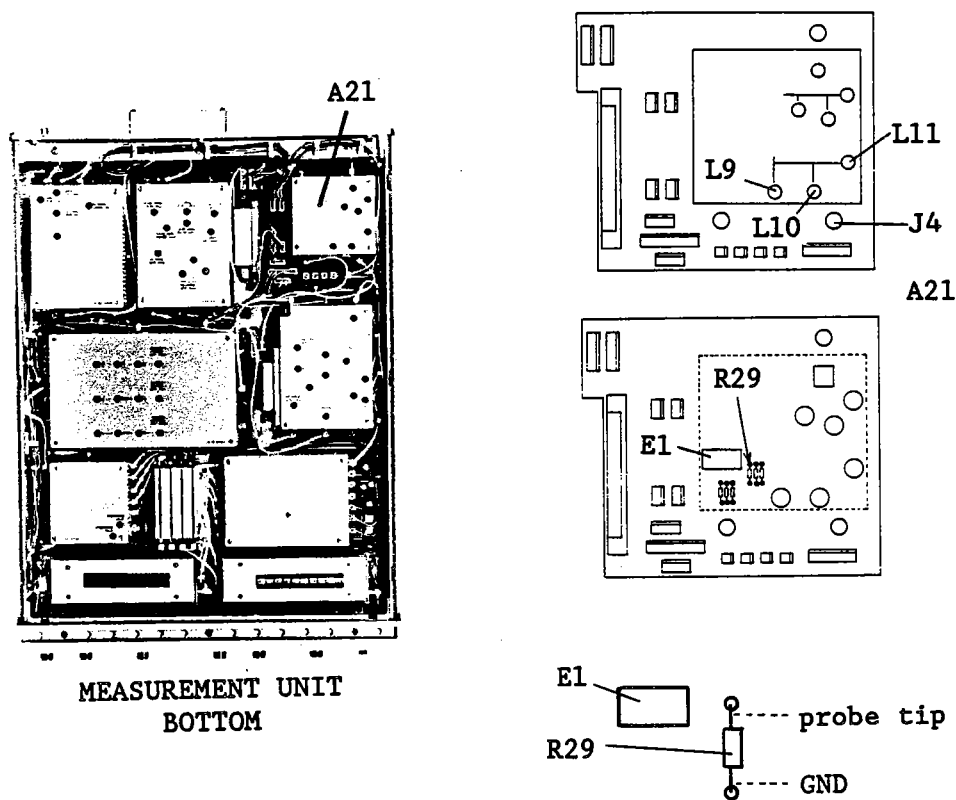

Figure 3-75. Receiver Second IF Converter 246 MHz BPF Adjustment Locations

2. Remove the shield cover from the A21 board.
3. Set up the Network Analyzer as follows.

Center Frequency	246.666 666 MHz
Frequency Span	20 MHz
Output Level	-10 dBm

4. Connect the Probe ground lead to the grounded lead of A21R29, and connect the probe tip to the other side of A21R29 as shown in Figure 3-75.
5. Adjust A21L9, L10, and L11 (246 MHz BPF ADJ) until the following conditions are satisfied. Refer to Figure 3-76.
 - a. No peak higher than the center frequency peak exists.
 - b. The center frequency should be close as possible to 246.666666 MHz.
 - c. The level at the center frequency should be maximum.

ADJUSTMENTS

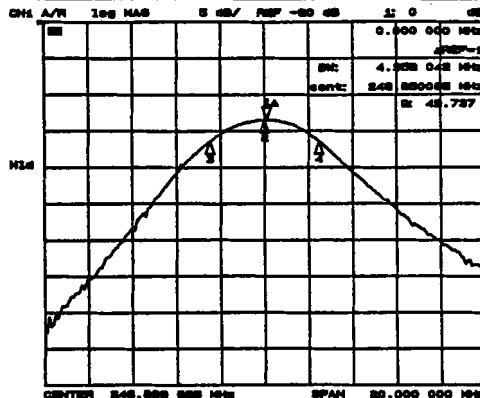
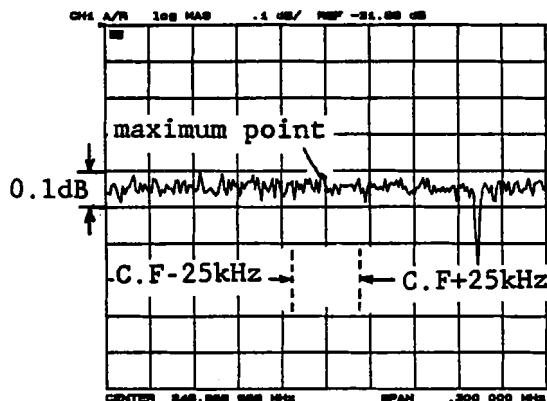

Figure 3-76. Receiver Second IF Converter 246 MHz BPF Adjustment Example 1

6. Change the Network Analyzer Span to 300 kHz.
7. Adjust A21L9, L10, and L11 (246MHz BPF ADJ) until the following conditions are satisfied. Refer to Figure 3-77.
 - a. Ripple at the center frequency ± 150 kHz should be < 0.1 dB.
 - b. The maximum point is within ± 25 kHz of the center frequency.



C.F: Center Frequency

Figure 3-77. Receiver Second IF Converter 246 MHz BPF Adjustment Example 2

8. Replace the shield cover on the A21 board.

3-17-2. SECOND IF CONVERTER 86.6 MHz BPF ADJUSTMENT

This procedure adjusts the First IF Converter 86.6 MHz Band Pass Filter. Before performing this procedure, complete the Receiver Second IF Converter 246 MHz BPF Adjustment, described in paragraph 3-17-1.

EQUIPMENT:

Network Analyzer	HP 8753A	
Signal Generator	HP 8656B	
Power Splitter	HP 11667A	
Mixer	HP 10514A	
3 dB Pad	HP 8491A Opt. 003	3 ea.
N(m)-N(m) Cable, 61 cm	HP 11500B	3 ea.
BNC(m)-BNC(m) Cable, 122 cm	PN 8120-1840	2 ea.
N(m)-BNC(f) Adapter	PN 1250-1476	2 ea.

ADJUSTMENTS

N(m)-N(m) Adapter	PN 1250-1475	
BNC(m)-N(f) Adapter	PN 1250-1477	3 ea.
Right Angle BNC Adapter	PN 1250-0076	
BNC(m)-SMB(f) Cable, 122 cm	PN 85680-60093	2 ea.

SUMMARY:

ADJUSTMENT COMPONENT: A21L4, L7, L8 (86.6MHz BPF ADJ)

TARGET: -3 dB Band Width: 3 MHz to 6 MHz
 Ripple at ± 150 kHz of the Center Frequency: 0.1 dB
 Position of maximum point: center frequency ± 25 kHz

PROCEDURE:

1. Connect the equipment as shown in Figure 3-78. See Figure 3-79 for the locations of A21J1 and A21J4.

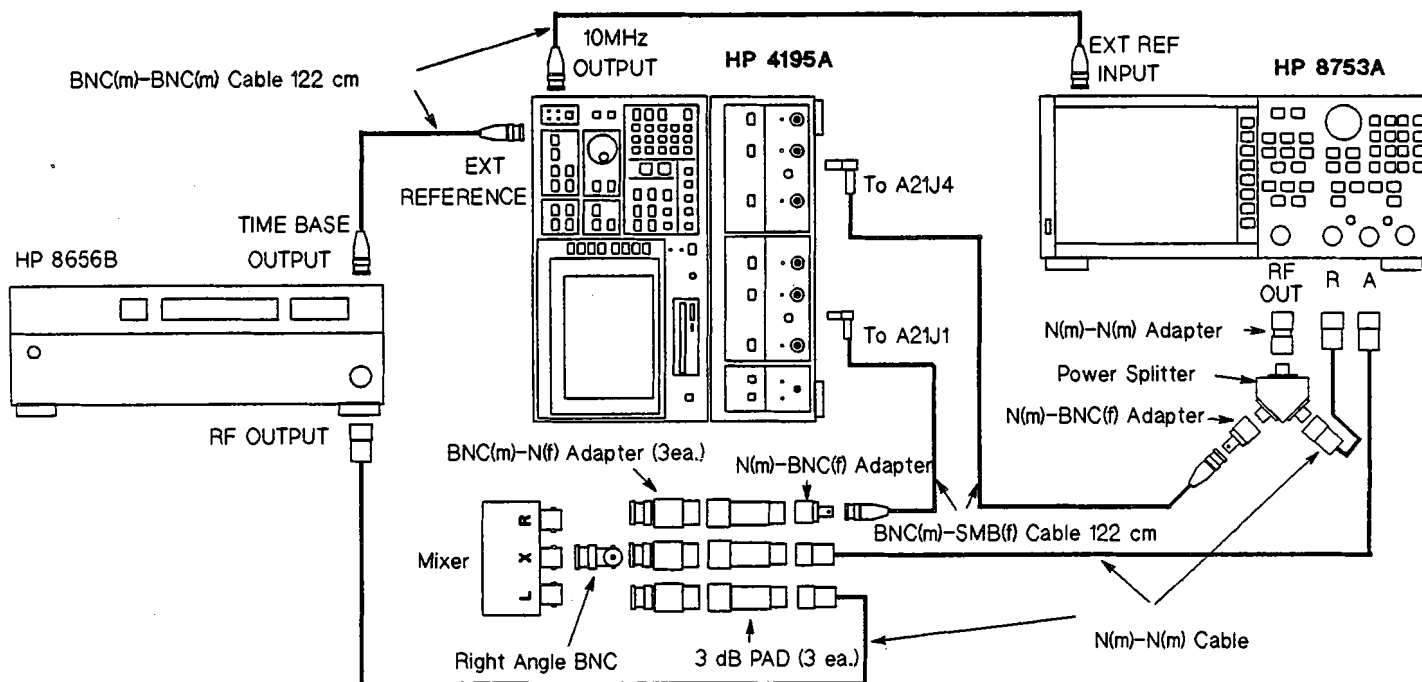

Figure 3-78. Receiver Second IF Converter 86.6 MHz BPF Adjustment Setup

ADJUSTMENTS

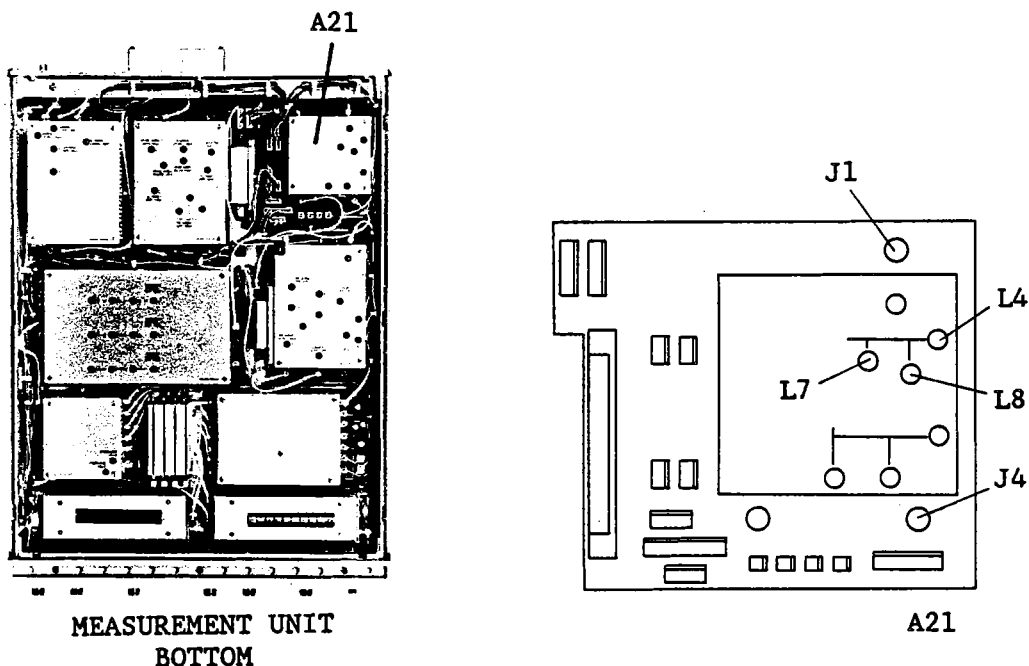

Figure 3-79. Receiver Second IF Converter 86.6 MHz BPF Adjustment Locations

2. Set up the Signal Generator as follows.

Output Frequency	160 MHz
Output Level	13 dBm

3. Set up the Network Analyzer as follows.

CENTER FREQUENCY	246.666 666 MHz
FREQUENCY SPAN	20 MHz
SOURCE POWER	-10 dBm

4. Set up the HP 4195A as follows.

		COMMAND
CONFIGURATION	NETWORK	FNC1
INITIALIZE	PRESET	RST
CENTER FREQUENCY	150 MHz	CENTER= 150 M
FREQUENCY SPAN	0 MHz	SPAN= 0

5. Adjust A21L4, L7 and L8 (86.6 MHz BPF ADJ) until the Network Analyzer displays a trace similar to that shown in Figure 3-80. The following are the conditions of the target trace.
 - a. No other peak higher than the center frequency peak exists.
 - b. The center frequency should be as close as possible to 246.666666 MHz.
 - c. -3 dB bandwidth should be 3 MHz to 6 MHz.

ADJUSTMENTS

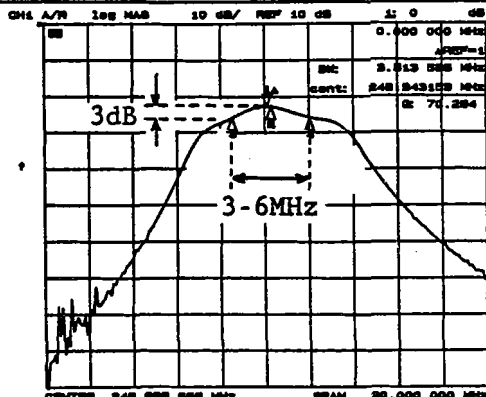
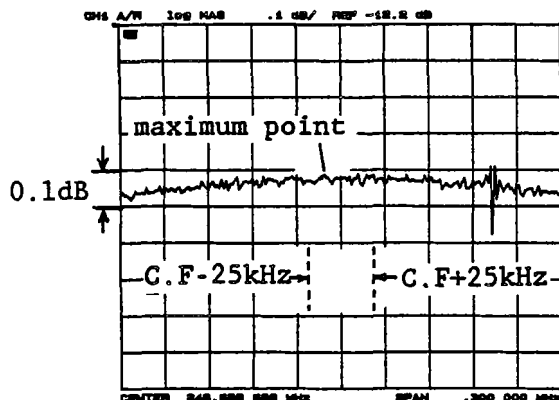

Figure 3-80. Receiver Second IF Converter 86.6 MHz BPF Adjustment Example 1

6. Change the Network Analyzer frequency Span to 300 kHz.
7. Adjust A21L4, L7, and L8 (86.6 MHz BPF ADJ) until the following conditions are satisfied. Refer to Figure 3-81.
 - a. The ripple in the range displayed by the Network Analyzer is less than 0.1 dB.
 - b. The maximum point should be within ± 25 kHz of the center frequency.

NOTE

Ignore any spikes that may appear on the trace, caused by mixer distortion.



C.F: Center Frequency

Figure 3-81. Receiver Second IF Converter 86.6 MHz BPF Adjustment Example 2

3-17-3. RECEIVER SECOND IF CONVERTER LEVEL ADJUSTMENT

This procedure adjusts the 86.6 MHz output signal level of the Receiver Second IF Converter. Before performing this procedure, complete the Receiver Second IF Converter BPF adjustments, described in paragraphs 3-17-1 and 3-17-2.

EQUIPMENT:

Signal Generator	HP 8656B	
Spectrum Analyzer	HP 8568B	
BNC(m)-BNC(m) Cable, 122 cm	PN 8120-1840	
N(m)-BNC(f) Adapter	PN 1250-1476	2 ea.
BNC(m)-SMB(f) Cable	PN 85680-60093	2 ea.
SMB(m)-SMB(m) Adapter	PN 1250-0813	

ADJUSTMENTS

SUMMARY:

ADJUSTMENT COMPONENT:

A21R9 (86.6 MHz LEVEL ADJ)

TARGET:

Gain: ± 0.1 dB

PROCEDURE:

1. Connect the equipment as shown in Figure 3-82.

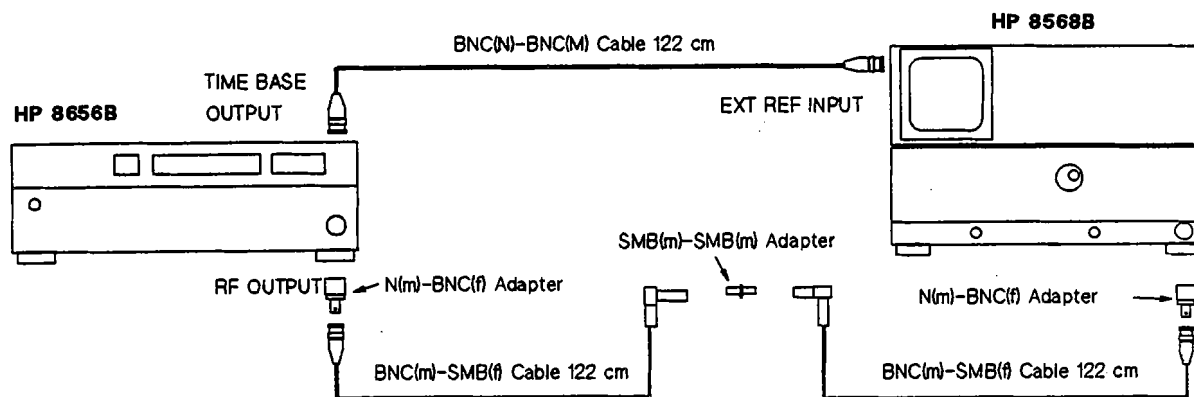

Figure 3-82. Second IF Converter Level Adjustment Setup (1 of 2)

2. Set up the Spectrum Analyzer as follows.

Center Frequency	246.667 MHz
Frequency Span	1 MHz

3. Set up the Signal Generator as follows.

Output Frequency	246.667 MHz
Output Level	-20 dBm

4. Make a note of the Signal Generator output level displayed by the Spectrum Analyzer.
5. Connect the equipment as shown in Figure 3-83. See Figure 3-84 for the locations of A21J1 and A21J4.

ADJUSTMENTS

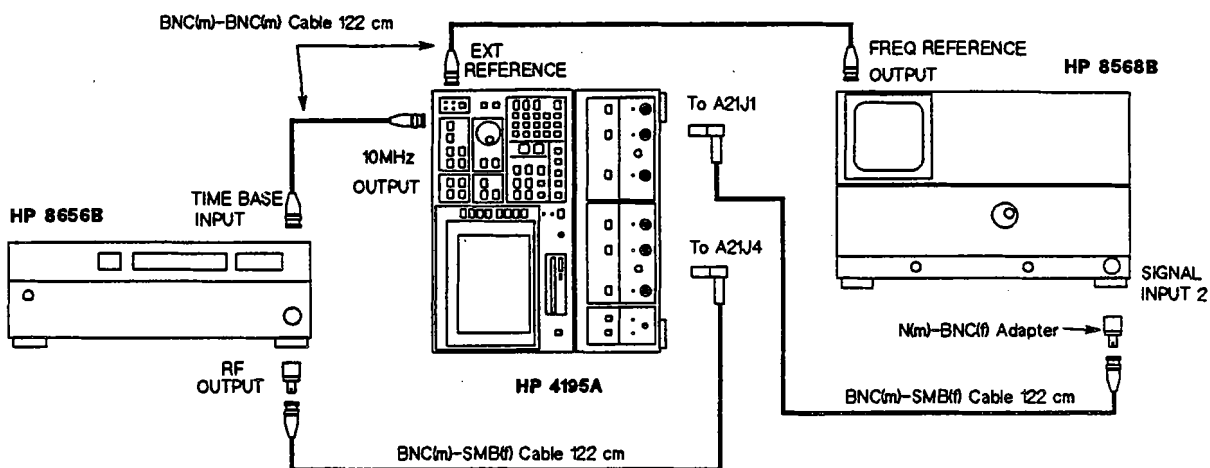

Figure 3-83. Second IF Converter Level Adjustment Setup (2 of 2)

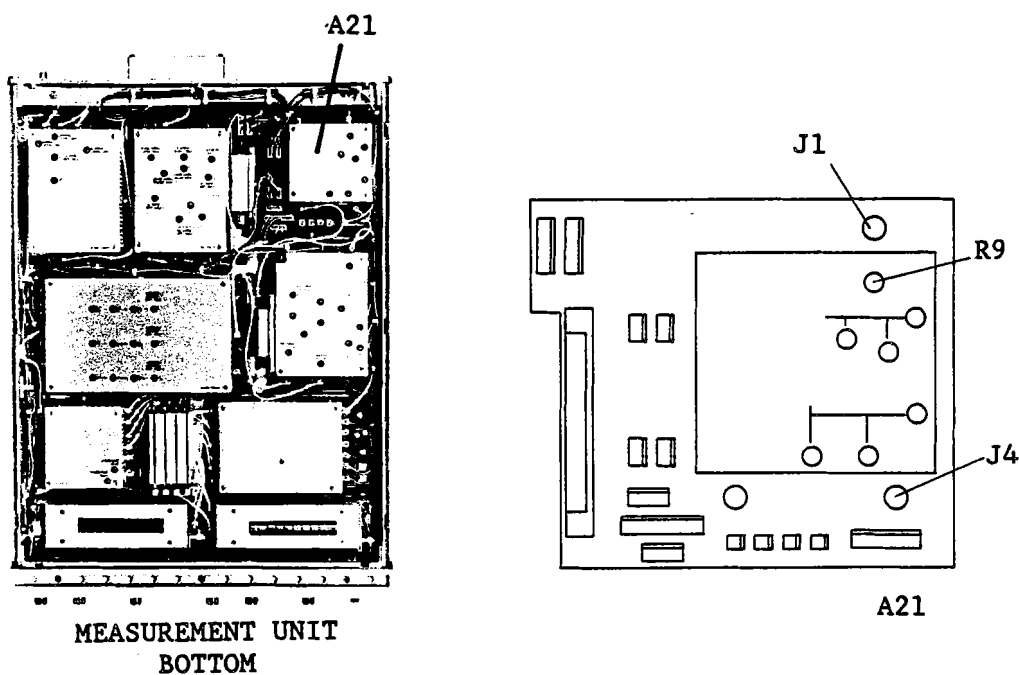

Figure 3-84. Second IF Converter Level Adjustment Locations

6. Change the Spectrum Analyzer Center Frequency to 86.667 MHz.
7. Turn the HP 4195A on.
8. Adjust A21R9 (86.6 MHz LEVEL ADJ) until the peak value displayed by the Spectrum Analyzer is within ± 0.1 dB of the Signal Generator output level measured in step 4.

NOTE

If you are unable to adjust the level as specified, adjust the 246MHz/86.6MHz Band Pass Filters as described in the section 3-17-1 and 3-17-2.

9. Reconnect coaxial cables (R) and (P) to A21J1 and A21J4, respectively.

3-18. RECEIVER THIRD IF CONVERTER ADJUSTMENTS

This procedure adjusts the 86.6 MHz, 6.9 MHz and 6.3 MHz Band Pass Filters, and the gain of the 20 dB/10 dB Amplifier in the Receiver Third IF Converter.

3-18-1. THIRD IF CONVERTER 86.6 MHz BPF ADJUSTMENT

This procedure adjusts 86.6 MHz Band Pass Filter of the Receiver Third IF Converter.

EQUIPMENT:

Network Analyzer	HP 8753A	
Power Splitter	HP 11667A	
Resistive Divider Probe	HP 10020A	
N(m)-N(m) Cable, 61 cm	HP 11500B	
BNC(m)-BNC(m) Cable, 122 cm	PN 8120-1840	
N(m)-BNC(f) Adapter	PN 1250-1476	2 ea.
N(m)-N(m) Adapter	PN 1250-1477	
BNC(m)-SMB(f) Cable, 122 cm	PN 85680-60093	

SUMMARY:

MONITOR: A20R41

ADJUSTMENT COMPONENT: A20L20, L21, L22 (86.6 MHz BPF ADJ)

TARGET: Ripple at ± 150 kHz from Center Frequency: 0.1 dB
 Position of maximum point: center frequency ± 25 kHz

PROCEDURE:

1. Remove the shield cover on the A20 board. Disconnect the cable (S) from A20J3. See Figure 3-86 for the location of A20J3.

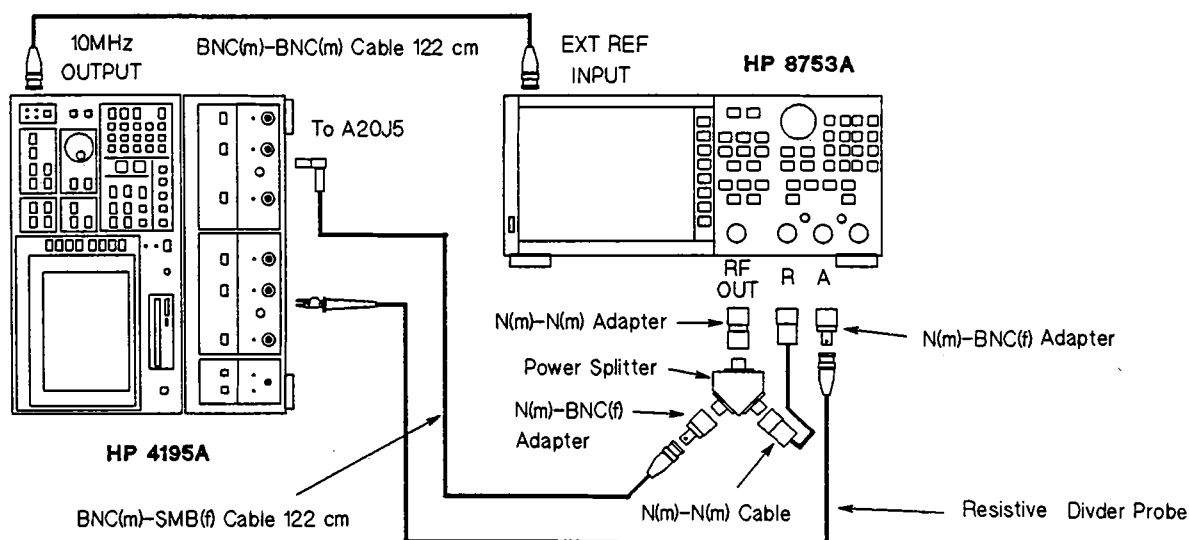

Figure 3-85. Receiver Third IF Converter 86.6 MHz BPF Adjustment Setup

ADJUSTMENTS

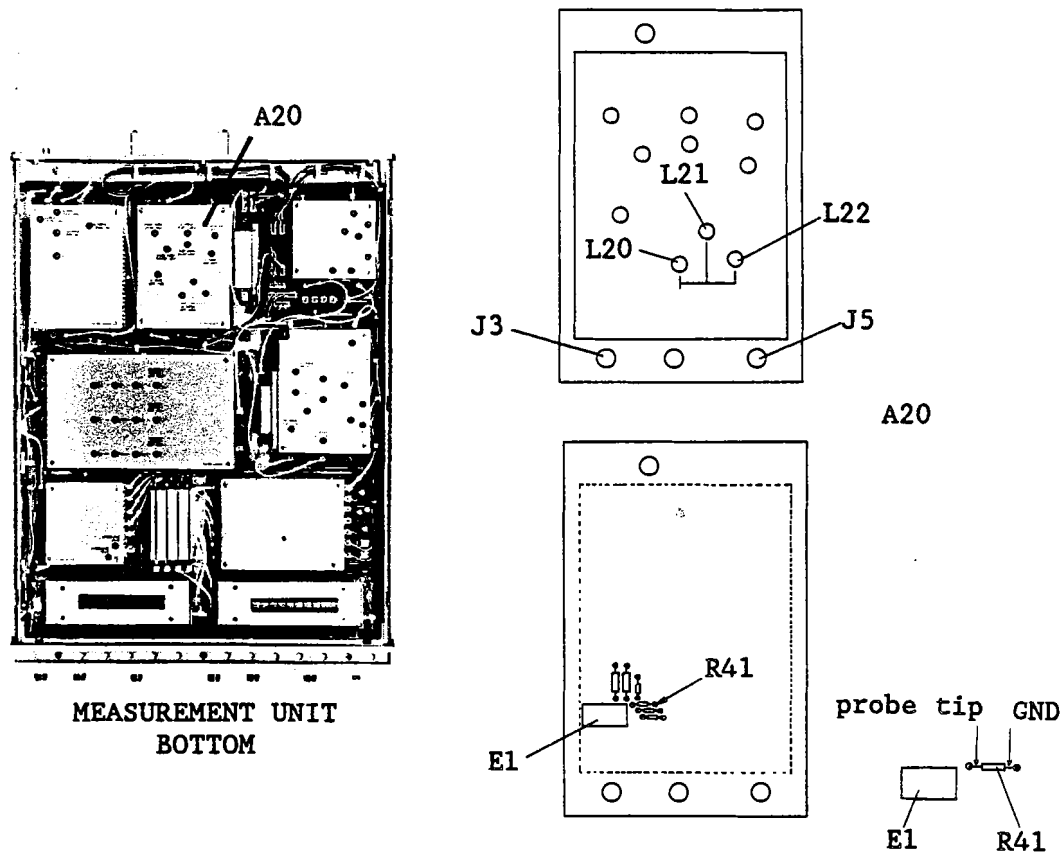

Figure 3-86. Receiver Third IF Converter 86.6 MHz BPF Adjustment Locations

2. Connect the equipment as shown in Figure 3-85. See Figure 3-86 for A20J5 location.
3. Set up the Network Analyzer as follows.

Center Frequency	86.666 666 MHz
Frequency Span	10 MHz
Source Power	-10 dBm

4. Set up the HP 4195A as follows.

COMMAND

CONFIGURATION	SPECTRUM	FNC2
INITIALIZE	PRESET	RST
CENTER FREQUENCY	80 MHz	CENTER= 80 M
FREQUENCY SPAN	0 Hz	SPAN= 0
TRIGGER MODE	external	TRGM2

5. Connect the Probe ground lead to the grounded lead of A20R41, and connect the tip of the probe to the other lead of A20R41. See Figure 3-86 for the probe locations.
6. Adjust A20L20, L21, and L22 (86.6 MHz BPF ADJ) until the center frequency is as close as possible to 86.666666 MHz, and the level at the center frequency is maximum. Refer to Figure 3-87.

ADJUSTMENTS

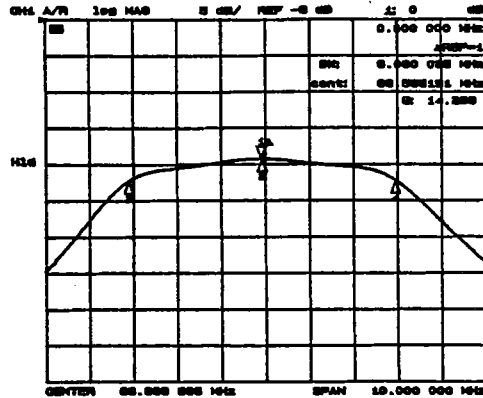
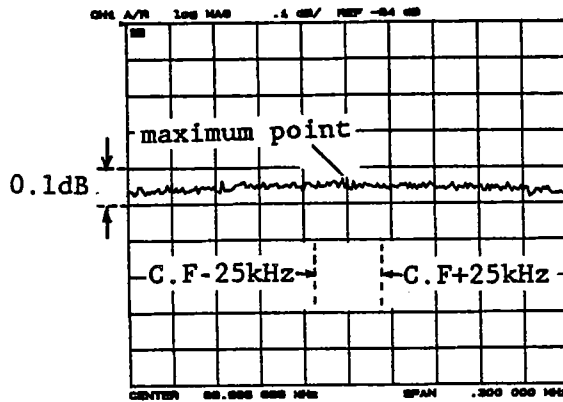

Figure 3-87. Receiver Third IF Converter 86.6 MHz BPF Adjustment Example 1

7. Change the Network Analyzer frequency Span to 300 kHz.
8. Adjust A20L20, L21, and L22 (86.6 MHz BPF ADJ) until the ripple is less than 0.1 dB, and the maximum point is within ± 25 kHz of the center frequency as shown in Figure 3-88.



C.F: Center Frequency

Figure 3-88. Receiver Third IF Converter 86.6 MHz BPF Adjustment Example 2

9. Reconnect coaxial cables (S) and (R) to A20J3 and A20J5, respectively.
10. Replace the shield cover on the A20 board.

3-18-2. THIRD IF CONVERTER 6.3/6.9 MHz BPF ADJUSTMENTS

This procedure adjusts the Receiver Third IF Converter 6.3 MHz and 6.9 MHz Band Pass Filters.

EQUIPMENT:

Network Analyzer	HP 8753A	
Signal Generator	HP 8656B	
Power Splitter	HP 11667A	
Mixer	HP 10514A	
3 dB Pad	HP 8491A Opt. 003	3 ea.
N(m)-N(m) Cable, 61 cm	HP 11500A	3 ea.
BNC(m)-BNC(m) Cable, 30 cm	PN 8120-1838	2 ea.
BNC(m)-BNC(m) Cable, 122 cm	PN 8120-1840	2 ea.
N(m)-BNC(f) Adapter	PN 1250-1476	2 ea.
N(m)-N(m) Adapter	PN 1250-1475	

ADJUSTMENTS

BNC(m)-N(f) Adapter
 Right Angle BNC Adapter
 BNC(m)-SMB(f) Cable, 122 cm

PN 1250-1477 3 ea.
 PN 1250-0076
 PN 85680-60093 2 ea.

464Ω Series Resistor

See paragraph 3-7

SUMMARY:

ADJUSTMENT COMPONENTS:

A20C16 (6.9 MHz BPF ADJ)
 A20C26 (6.3 MHz BPF ADJ)
 A20R38 (FLATNESS ADJ)

TARGET: 3 dB Pass Band: 86.166 666 MHz to 87.166 666 MHz
 Ripple at ±150 kHz of Center Frequency: < 0.1 dB

PROCEDURE:

1. Connect the equipment as shown in Figure 3-89. See Figure 3-90 for the locations of A20J1 and A20J5.

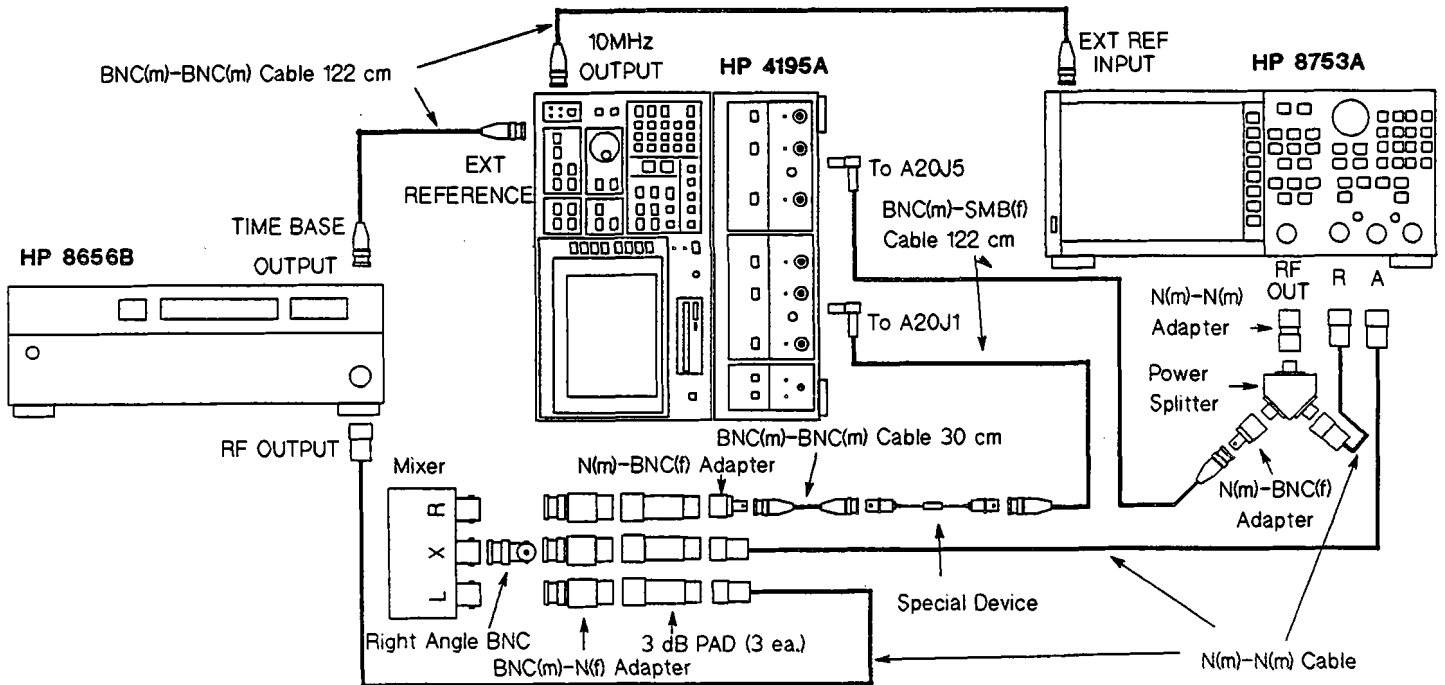

Figure 3-89. Receiver Third IF Converter 6.3/6.9 MHz BPF Adjustment Setup

ADJUSTMENTS

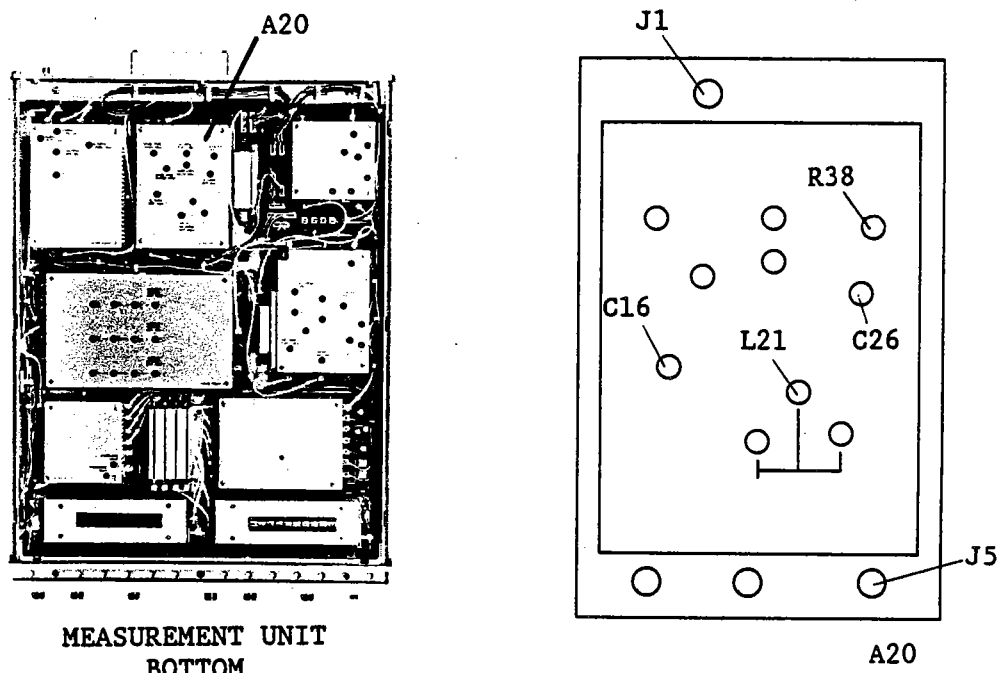

Figure 3-90. Receiver Third IF Converter 6.3/6.9 MHz BPF Adjustment Locations

2. Set up the Signal Generator as follows.

Output Frequency	80 MHz
Output Level	13 dBm

3. Set up the Network Analyzer as follows.

Center Frequency	86.666 666 MHz
Frequency Span	1 MHz
Output Level	-10 dBm

4. Set up the HP 4195A as follows.

COMMAND

CONFIGURATION	SPECTRUM	FNC2
INITIALIZE	PRESET	RST
CENTER FREQUENCY	149.999 999 MHz	CENTER= 149.999999 M
FREQUENCY SPAN	0 Hz	SPAN= 0
TRIGGER MODE	external	TRGM2

5. Adjust A20C16 (6.9 MHz BPF ADJ) until the trace intersects the right most axis (87.166666 MHz) with level of 3 dB down from the center frequency level.

ADJUSTMENTS

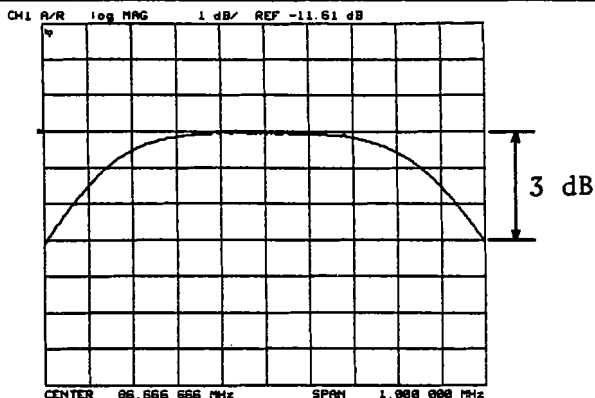

Figure 3-91. Receiver Third IF Converter 6.3/6.9 MHz BPF Adjustment Example 1

6. Adjust **A20C26 (6.3 MHz BPF ADJ)** until the trace intersects the left most axis (86.166666 MHz) with a level of 3 dB down from the center frequency level.
7. Change the Network Analyzer Frequency Span to 300 kHz.
8. Adjust **A20R38 (FLATNESS ADJ)** until the ripple is less than 0.1 dB as shown in Figure 3-92.

NOTE

If the ripple can not be adjusted within the range, repeat steps 6 through 8. If it still cannot be adjusted, perform the adjustment described in paragraph 3-18-1.

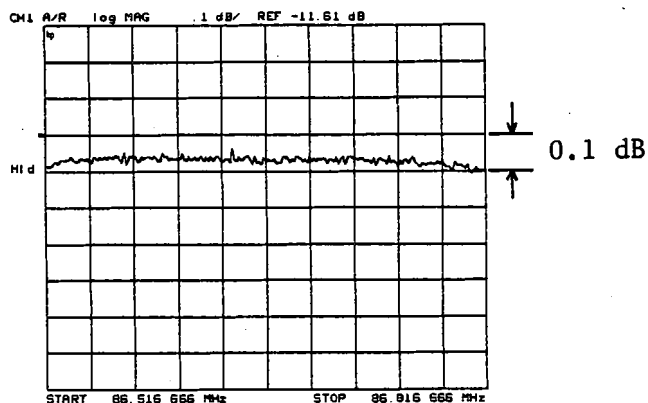

Figure 3-92. Receiver Third IF Converter 6.3/6.9 MHz BPF Adjustment Example 2

9. Reconnect coaxial cables (4) and (R) to A20J1 and A20J5, respectively.

3-18-3. 20 dB AMPLIFIER GAIN/PHASE ADJUSTMENT

This procedure adjusts the gain and phase of the Third IF Converter 20 dB Amplifier.

EQUIPMENT:

N(m)-N(m) Cable, 61 cm

HP 11500B

SUMMARY:

MONITOR:

Service Function No. 19 display

ADJUSTMENTS

ADJUSTMENT COMPONENTS: Gain: A20R19 (20 dB AMPL GAIN ADJ)
Phase: A20C18 (20 dB AMPL PHASE ADJ)

TARGET: Gain: 0 ±0.01 dB
Phase: 0 ±0.05 deg

PROCEDURE:

1. Position the HP 4195A on its left side as shown in Figure 3-93.
2. Connect the N(m)-N(m) Cable from OUTPUT S1 to INPUT R1 as shown in Figure 3-93.

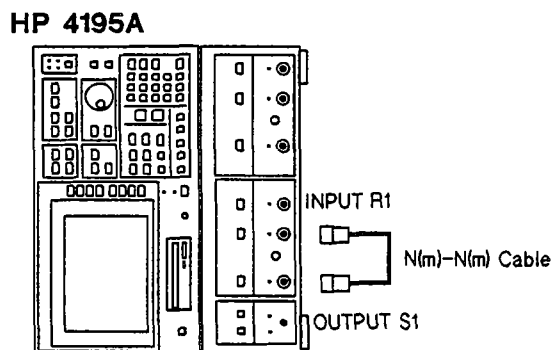

Figure 3-93. Third IF Converter Amplifier Adjustment Setup

3. Enter the "STSET" command from the Keyboard Input Line using the following key strokes to display the Service Function Menu.

Blue shiftkey, S, T, S, E, T, ENTER/EXECUTE key

4. Enter the "STN=19" command using the following key strokes to display Service Function No. 19.

'TEST No.' softkey, 1, 9, ENTER/EXECUTE key

5. Press the HP 4195A 'START' softkey.

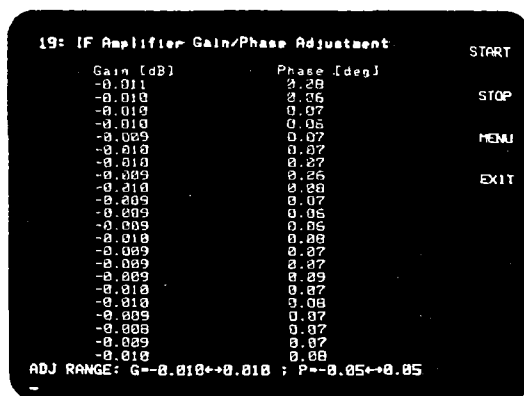

Figure 3-94. Third IF Converter 20 dB Amplifier Adjustment Example

ADJUSTMENTS

6. Adjust A20R19 (20 dB AMPL GAIN ADJ) until the Gain [dB] on the HP 4195A display is 0 ± 0.01 dB. Read the bottom of the Gain column for the value.
7. Adjust A20C18 (20 dB AMPL PHASE ADJ) until the Phase [deg] value is 0 ± 0.05 deg.

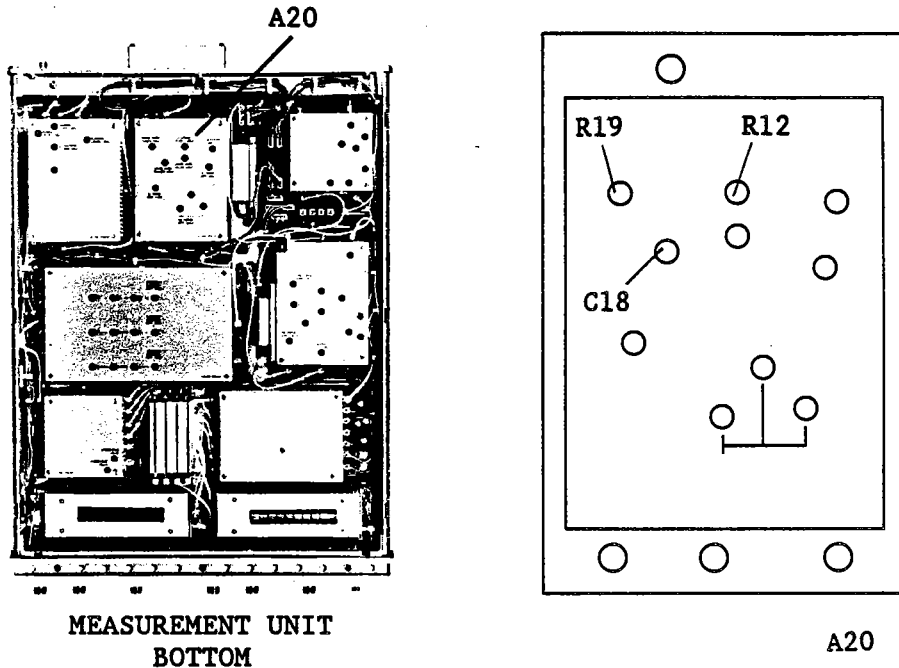

Figure 3-95. Third IF Converter 20 dB Amplifier Adjustment Locations

8. Repeat steps 6 and 7 until the conditions of both steps are satisfied.
9. Press the 'EXIT' softkey.

3-18-4. THIRD IF CONVERTER 6.6 MHz LEVEL ADJUSTMENT

This procedure adjusts the 6.6 MHz output level of the third IF converter.

EQUIPMENT:

Spectrum Analyzer	HP 8568B	
BNC(m)-BNC(m) Cable, 30 cm	PN 8120-1838	
BNC(m)-BNC(m) Cable, 122 cm	PN 8120-1840	
N(m)-BNC(f) Adapter	PN 1250-1476	2 ea.
SMB(m)-SMB(m) Adapter	PN 1250-0813	
BNC(m)-SMB(f) Cable, 122 cm	PN 85680-60093'	2 ea.
Special Device (464Ω Resistor)	See paragraph 3-7	

SUMMARY:

MONITOR:	A20J1
ADJUSTMENT COMPONENT:	A20R12 (6.6 MHz LEVEL ADJ)

ADJUSTMENTS

TARGET: 12 dB \pm 0.1 dB greater than the HP 4195A's **OUTPUT S1** output level

PROCEDURE:

1. Position the HP 4195A on its left side as shown in Figure 3-96.
2. Connect the equipment as shown in Figure 3-96.

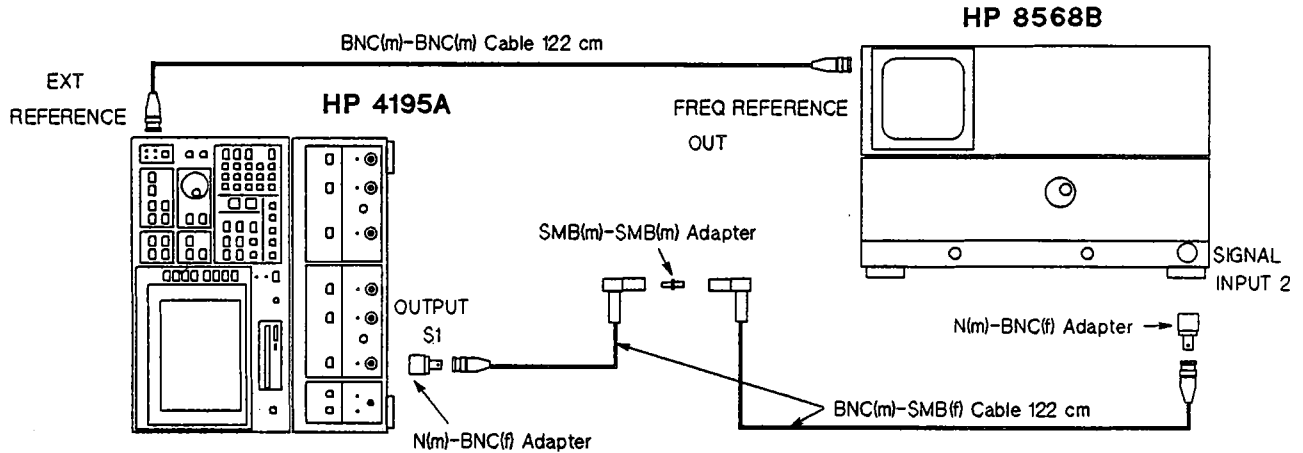

Figure 3-96. Third IF converter Level Adjustment Setup (1 of 2)

3. Disconnect coaxial cables (4) and (R) from A20J1 and A20J5, respectively. See Figure 3-97 for the locations of A20J1 and A20J5.
4. Set up the Spectrum Analyzer as follows.

Center Frequency	86.667 MHz
Frequency Span	1 MHz

5. Set up the HP 4195A as follows. Do not turn the HP 4195A off during this adjustment.

COMMAND

CONFIGURATION	SPECTRUM	FNC2
INITIALIZE	PRESET	RST
CENTER FREQUENCY	86.666 666 MHz	CENTER= 86.666 666 M
FREQUENCY SPAN	0 Hz	SPAN= 0
OUTPUT PORT (S1)	ON	PWR1
OUTPUT LEVEL (S1)	-24 dBm	OSC1= -24
IF RANGE	LOW DISTORTION	IRNG2

NOTE

Press the **MORE**, 'IF RANGE' keys to select the IF RANGE.

6. Make a note of the HP 4195A output level displayed by the Spectrum Analyzer.
7. Connect the equipment as shown in Figure 3-97.

ADJUSTMENTS

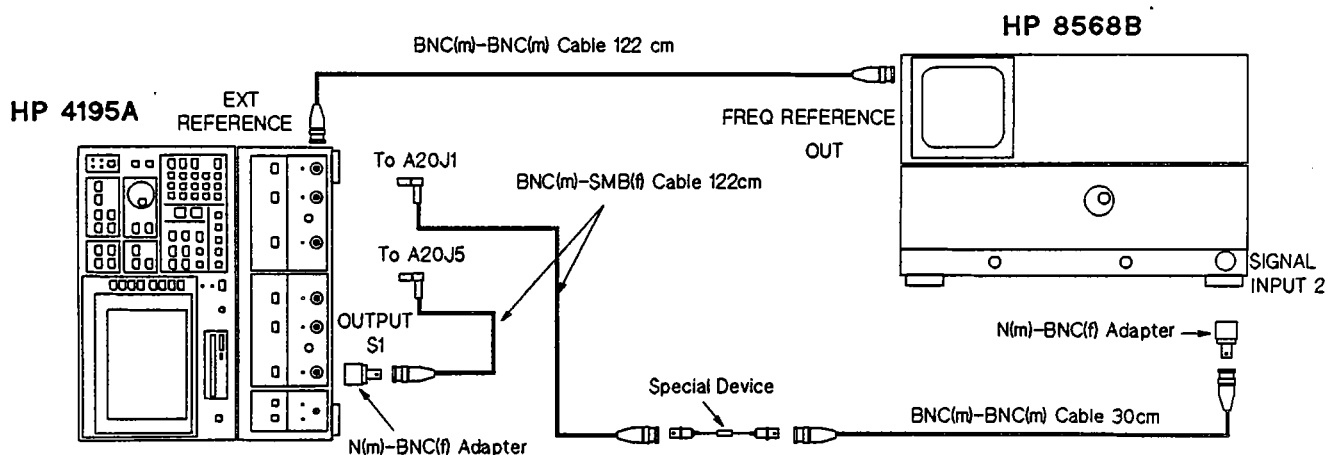

Figure 3-97. Third IF Converter Level Adjustment Setup (2 of 2)

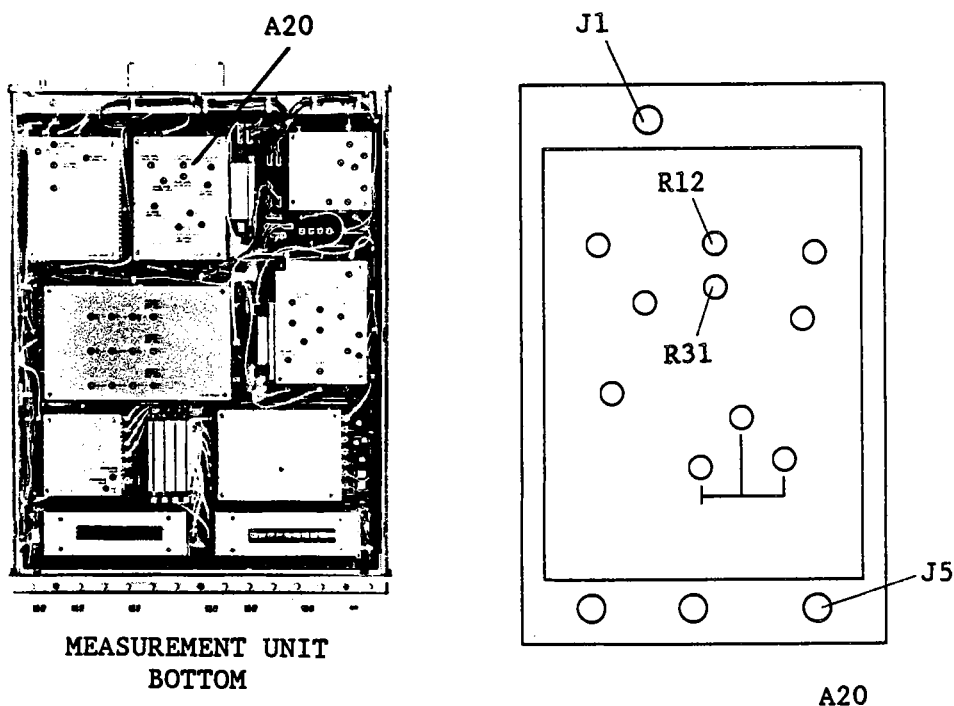

Figure 3-98. Third IF Converter 6.6 MHz Level Adjustment Locations

8. Change the Spectrum Analyzer Center Frequency to 6.667 MHz.
9. Adjust A20R12 (6.6 MHz LEVEL ADJ) until the peak level displayed by the Spectrum Analyzer is 12 dB \pm 0.1 dB greater than the output level measured in step 6.

NOTE

If you are unable to adjust the level as specified, perform the adjustments described in the sections 3-18-1 through 3-18-3.

3-18-5. 10 dB AMPLIFIER GAIN ADJUSTMENT

This procedure adjusts the Third IF Converter 10 dB Amplifier gain.

ADJUSTMENTS

- Adjust A20R31 (10 dB AMPL GAIN ADJ) until the Gain [dB] value displayed by the HP 4195A is 0 ± 0.05 dB.

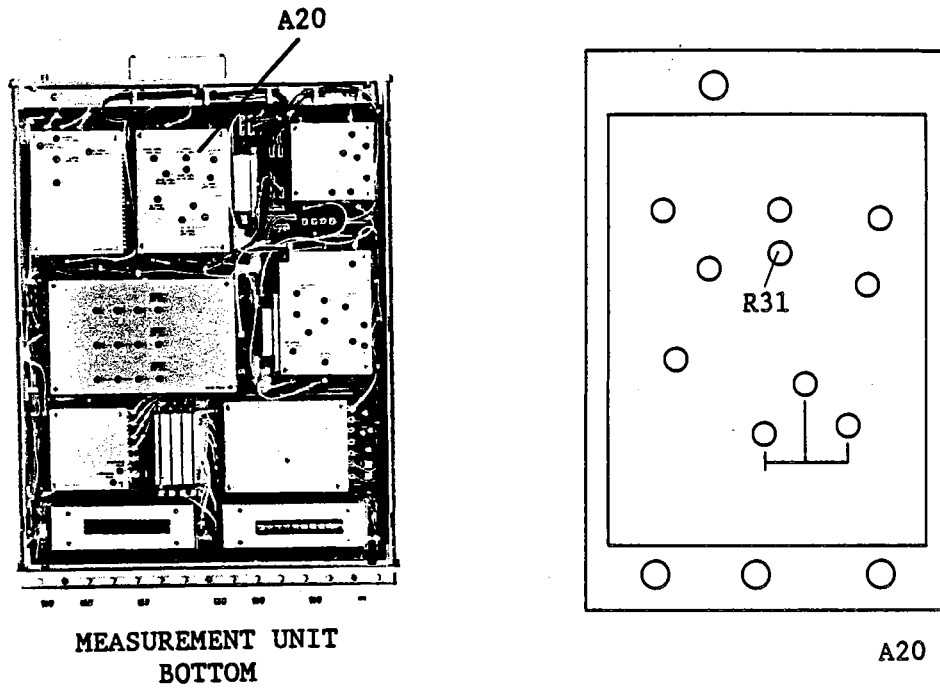

Figure. 3-100. Receiver Third IF Converter 10 dB Amplifier Adjustment Locations

3-19. SOURCE SECOND/THIRD IF CONVERTER ADJUSTMENTS

This procedure adjusts the 86.6 MHz Band Pass Filter, the 246 MHz Band Pass Filter, and the output level of the Source Second/Third IF Converter.

3-19-1. SECOND IF CONVERTER FIRST 86.6 MHz BPF ADJUSTMENT

This procedure adjusts the 86.6 MHz Band Pass Filter of the source second IF converter.

EQUIPMENT:

Network Analyzer	HP 8753A	
Signal Generator	HP 8656B	
Power Splitter	HP 11667A	2 ea.
Mixer	HP 10514A	
3 dB Pad	HP 8491A Opt.003	3 ea.
N(m)-N(m) Cable, 61 cm	HP 11500B	3 ea.
BNC(m)-BNC(m) Cable, 122 cm	PN 8120-1840	
N(m)-BNC(f) Adapter	PN 1250-1476	3 ea.
N(m)-N(m) Adapter	PN 1250-1475	2 ea.
BNC(m)-N(f) Adapter	PN 1250-1477	3 ea.
Right Angle BNC Adapter	PN 1250-0076	
BNC(m)-SMB(f) Cable	PN 85680-60093	3 ea.

SUMMARY:

ADJUSTMENT COMPONENT:	A40L1, L2 (86.6 MHz BPF 1 ADJ)
TARGET:	Level at 80 MHz: < -25 dBc

PROCEDURE:

1. Remove one of the shield covers (PN 04195-00654) from the A40 board. See Figure 3-102 for the location of the A40 board and the cover to be removed.
2. Connect the equipment as shown in Figure 3-101. See Figure 3-102 for the locations of A40J1, A40J5, and A40J7.

NOTE

Confirm that the HP 4195A is off. DO NOT turn the HP 4195A on during this adjustment.

ADJUSTMENTS

5. Set up the Signal Generator as follows.

Output Frequency	6.66666 MHz
Output Level	10 dBm

6. Vary the Signal Generator Output Frequency from 4 MHz to 9 MHz, so that the gain within the BPF pass band displayed by the Network Analyzer is maximized.

7. Adjust A40L1, L2 (86.6MHz BPF 1 ADJ) until the level at the center frequency (86.666 666 MHz) on the Network Analyzer display is maximum, and the level at 80 MHz is < -25 dBc as shown in Figure 3-103.

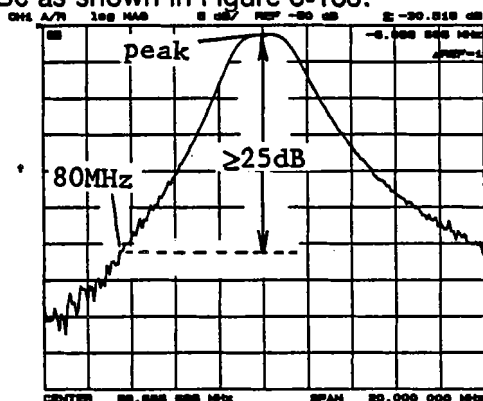

Figure 3-103. Source Second IF Converter First 86.6 MHz BPF Adjustment Example

3-19-2. SECOND IF CONVERTER SECOND 86.6 MHz BPF ADJUSTMENT

This procedure adjusts the second 86.6 MHz Band Pass Filter of the source second IF converter. Before performing this adjustment, complete the procedures in paragraph 3-19-1.

EQUIPMENT:

Network Analyzer	HP 8753A	
Power Splitter	HP 11667A	
N(m)-N(m) Cable, 61 cm	HP 11500B	
N(m)-BNC(f) Adapter	PN 1250-1476	2 ea.
N(m)-N(m) Adapter	PN 1250-1475	
BNC(m)-SMB(f) Cable, 122 cm	PN 85680-60093	2 ea.
Interconnection Cable, 9 pin	PN 16349-61601	
Interconnection Cable, 50 pin	PN 16349-61602	

SUMMARY:

ADJUSTMENT COMPONENT: A40L3, L4, L9 (86.6 MHz BPF 2 ADJ)

TARGET: Level at 80 MHz: < -28 dBc

PROCEDURE:

1. Remove one of the shield covers (PN 04195-00654) from the A40 board. See Figure 3-105 for the location of the A40 board and the cover to be removed.
2. Connect the equipment as shown in Figure 3-104.

ADJUSTMENTS

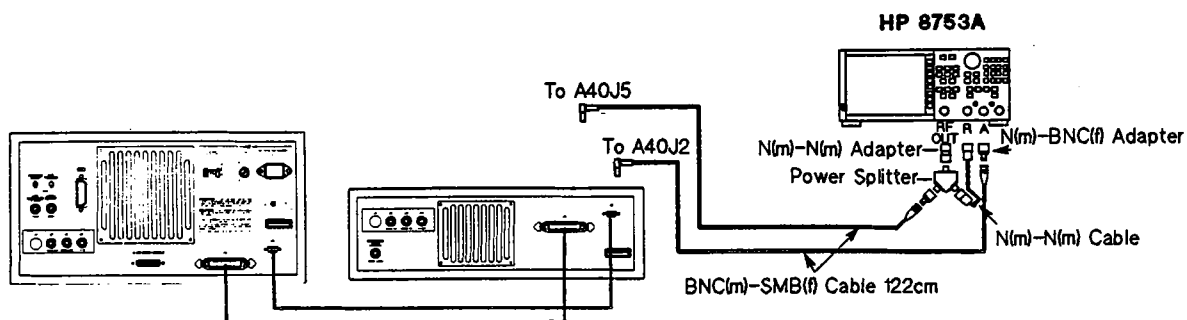

Figure 3-104. Source Second IF Converter Second 86.6 MHz BPF Adjustment Setup

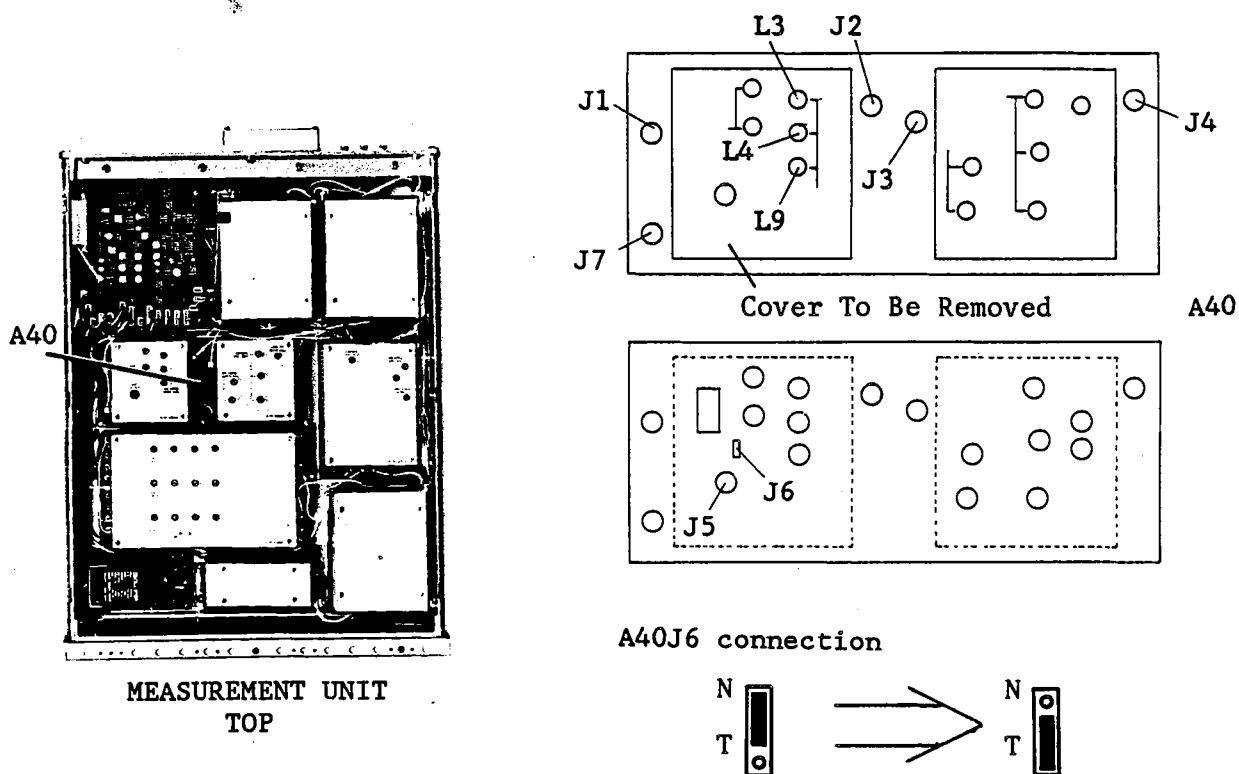

Figure 3-105. Source Second IF Converter Second 86.6 MHz BPF Adjustment Locations

3. Change the jumper position of A40J6 "N" to "T" as shown in Figure 3-104.
4. Disconnect coaxial cables (H), (D), (B), and (N) from A40J1, A40J3, A40J4, and A40J7, respectively.
5. Set up the Network Analyzer as follows.

Center Frequency	86.666 666 MHz
Frequency Span	20 MHz
Source Power	-10 dBm
6. Turn the HP 4195A on.
7. Adjust A40L3, L4, and L9 (86.6 MHz BPF 2 ADJ) until the level at the center frequency (86.666 666 MHz) on the Network Analyzer display is maximum, and the level at 80 MHz is < -28 dBc (no other higher peak than the center frequency peak exists).

ADJUSTMENTS

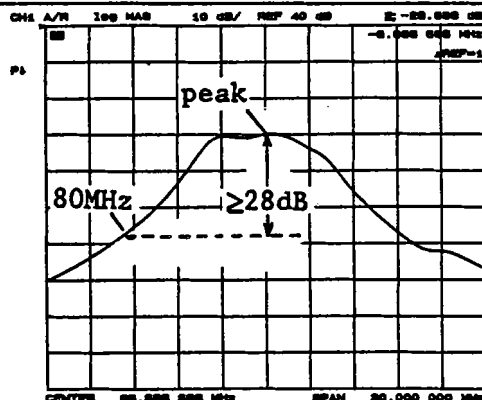

Figure 3-106. Source Second IF Converter Second 86.6 MHz BPF Adjustment Example

8. Reposition jumper A40J6 to the "N" position.

3-19-3. THIRD IF CONVERTER 246 MHz BPF ADJUSTMENT

This procedure adjusts the 246 MHz Band Pass Filter of the source third IF converter. Before performing this procedure, complete the procedure described in paragraph 3-19-2.

EQUIPMENT:

Network Analyzer	HP 8753A	
Signal Generator	HP 8656B	
Power Splitter	HP 11667A	2 ea.
Mixer	HP 10514A	
3 dB Pad	HP 8491A Opt.003	3 ea.
N(m)-N(m) Cable, 61 cm	HP 11500B	3 ea.
BNC(m)-BNC(m) Cable, 122 cm	PN 8120-1840	
N(m)-BNC(f) Adapter	PN 1250-1476	3 ea.
N(m)-N(m) Adapter	PN 1250-1475	2 ea.
BNC(m)-N(f) Adapter	PN 1250-1477	3 ea.
Right Angle BNC Adapter	PN 1250-0076	
BNC(m)-SMB(f) Cable	PN 85680-60093	3 ea.
Interconnection Cable, 9 pin	PN 16349-61601	
Interconnection Cable, 50 pin	PN 16349-61602	

SUMMARY:

ADJUSTMENT COMPONENT: A40L5, L11, L17 (246 MHz BPF ADJ)

TARGET: Level at 233.3 MHz: 25 dB less than the peak level

PROCEDURE:

1. Connect the equipment as shown in Figure 3-107. See Figure 3-108 for the locations of A40J2, A40J3 and A40J4.
2. Disconnect coaxial cables (H), and (N) from connectors A40J1, and A40J7.

ADJUSTMENTS

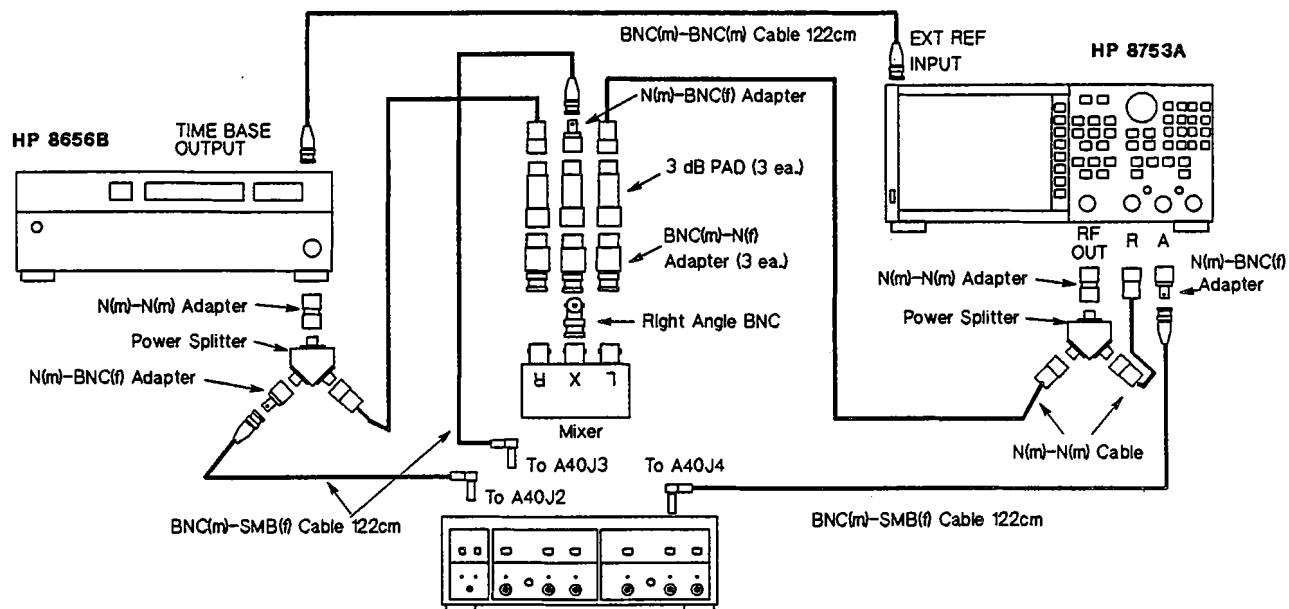

Figure 3-107. Source Third IF Converter 246 MHz BPF Adjustment Setup

3. Set up the Network Analyzer as follows.

Center Frequency	247.666 666 MHz
Frequency Span	50 MHz
Source Power	10 dBm

4. Set up the Signal Generator as follows.

Output Frequency	87 MHz
Output Level	10 dBm

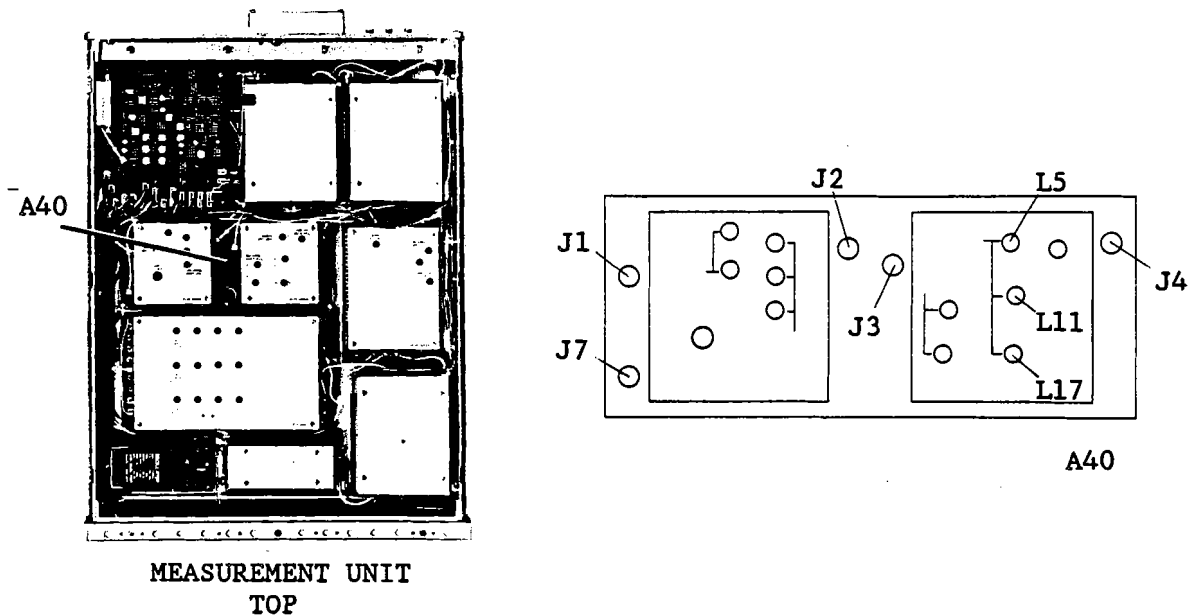

MEASUREMENT UNIT
TOP

Figure 3-108. Source Third IF Converter 246 MHz BPF Adjustment Locations

ADJUSTMENTS

5. Turn the HP 4195A on.
6. Vary the Signal Generator Output Frequency from 80 MHz to 95 MHz, so that the gain within the BPF pass band displayed by the Network Analyzer is maximized.
7. Adjust A40L5, L11, and L17 (246 MHz BPF ADJ) until the signal level at the center frequency (247.666 666 MHz) on the Network Analyzer is maximum, and the level at 233.3 MHz is < -25 dBc (no peak higher than the center frequency peak exists).

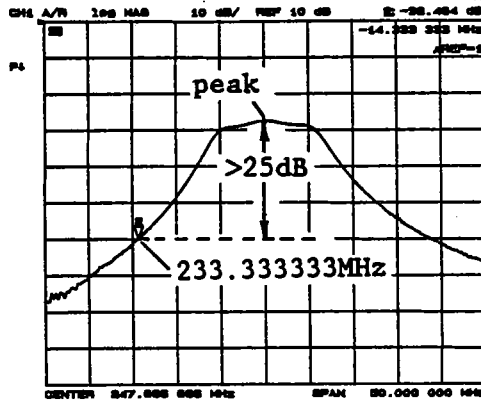

Figure 3-109. Source Third IF Converter 246 MHz BPF Adjustment Example

3-19-4. THIRD IF CONVERTER 86.6 MHz BPF ADJUSTMENT

This procedure adjusts the 86.6 MHz Band Pass Filter of the source third IF converter. Before performing this procedure, complete the procedure in paragraph 3-19-3.

EQUIPMENT:

Network Analyzer	HP 8753A	
Signal Generator	HP 8656B	
Power Splitter	HP 11667A	2 ea.
Mixer	HP 10514A	
3 dB Pad	HP 8491A Opt. 003	3 ea.
50Ω Termination	HP 909C Opt. 012	
N(m)-N(m) Cable, 61 cm	HP 11500B	3 ea.
BNC(m)-BNC(m) Cable, 30 cm	PN 8120-1838	
BNC(m)-BNC(m) Cable, 122 cm	PN 8120-1840	
N(m)-BNC(f) Adapter	PN 1250-1476	3 ea.
N(m)-N(m) Adapter	PN 1250-1475	2 ea.
BNC(m)-N(f) Adapter	PN 1250-1477	3 ea.
Right Angle BNC Adapter	PN 1250-0076	
BNC(m)-SMB(f) Cable	PN 85680-60093	3 ea.
BNC(f)-SMB(f) Adapter	PN 1250-1236	
Interconnection Cable, 9 pin	PN 16349-61601	
Interconnection Cable, 50 pin	PN 16349-61602	
N(f)-BNC(f) Adapter	PN 1250-1474	

SUMMARY:

ADJUSTMENT COMPONENT: A40L10, L16 (86.6 MHz BPF 3 ADJ)

TARGET: Level at 246.6 MHz: maximum

ADJUSTMENTS

PROCEDURE:

1. Remove one of the shield covers (PN 04195-00654) from the A40 board, and set jumper A40J6 setting from "N" to the "T" position. Refer to Figure 3-111.
2. Connect the equipment as shown in Figure 3-110. See Figure 3-111 for A40J2, A40J3, A40J4 and A40J5 locations.

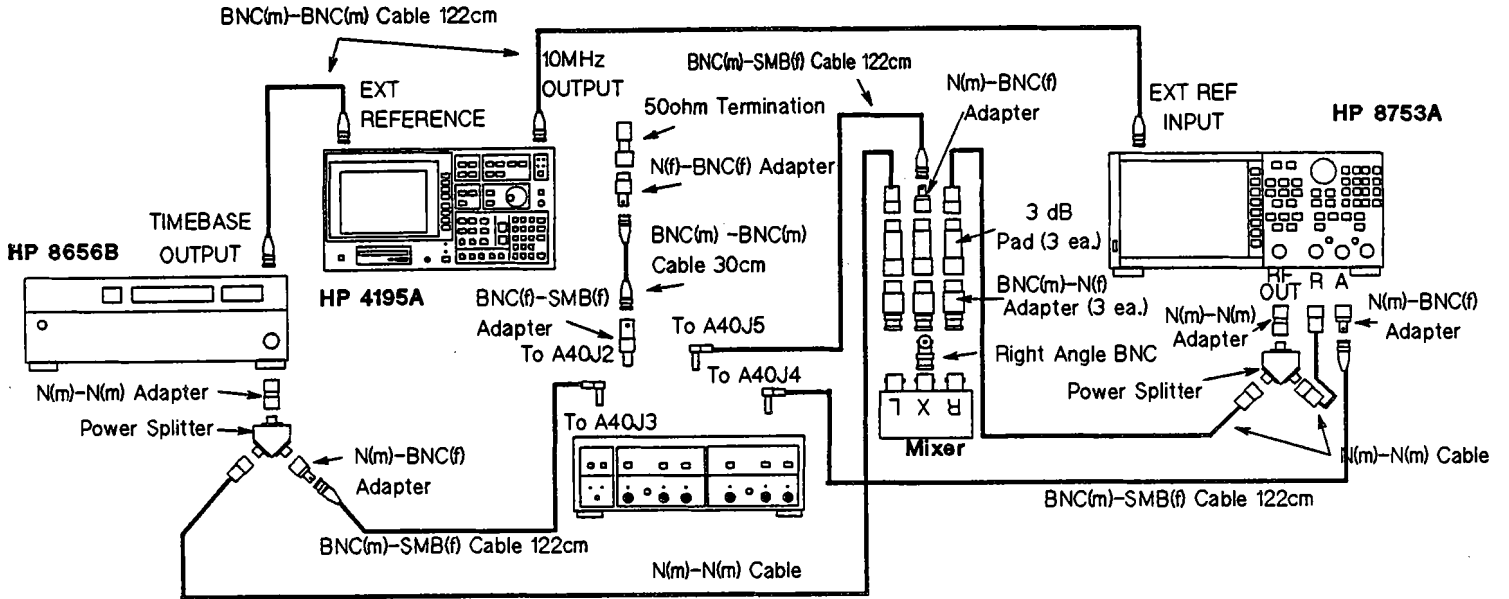
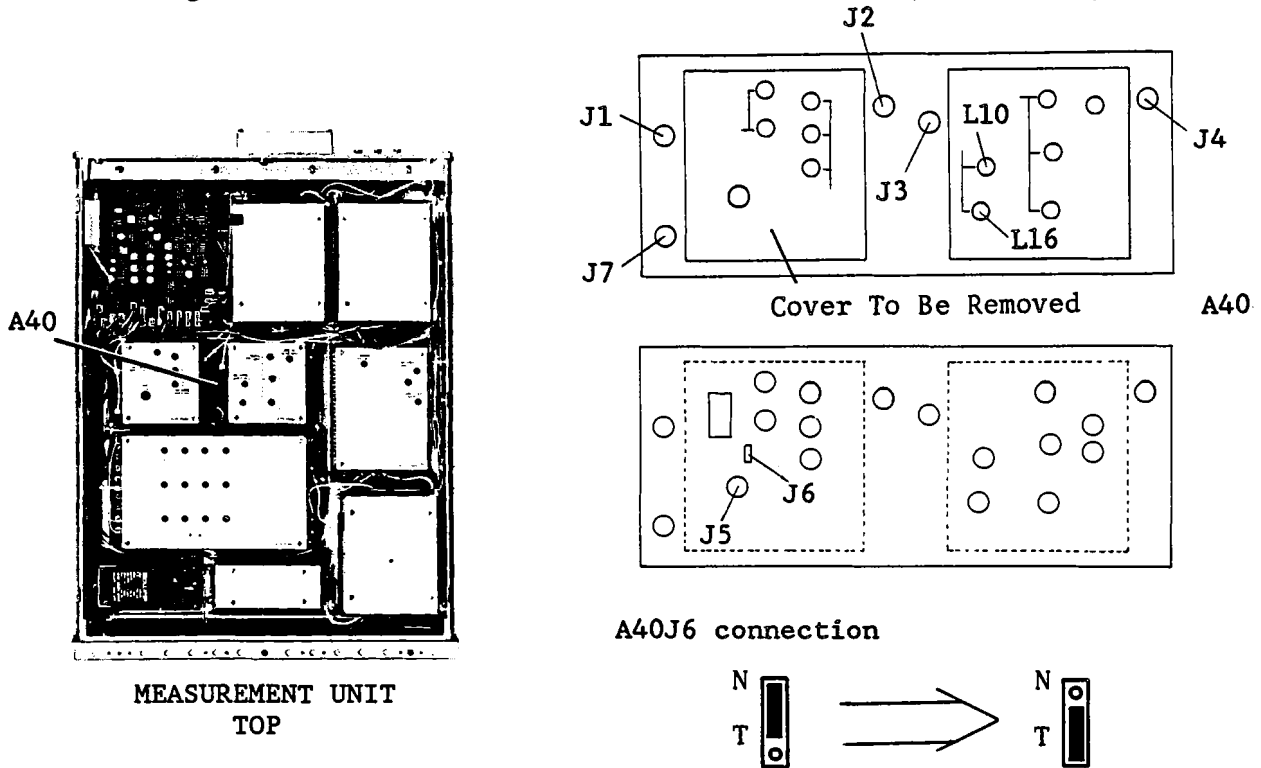

Figure 3-110. Source Third IF Converter 86.6 MHz BPF Adjustment Setup



MEASUREMENT UNIT
TOP

A40J6 connection

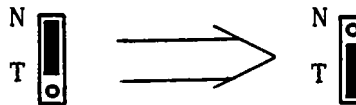

Figure 3-111. Source Third IF Converter 86.6 MHz BPF Adjustment Locations

ADJUSTMENTS

3. Disconnect coaxial cables (H), and (N) from A40J1, and A40J7, respectively.
4. Set up the Network Analyzer as follows.

Center Frequency	246.666 666 MHz
Frequency Span	20 MHz
Source Power	10 dBm

5. Set up the Signal Generator as follows.

Output Frequency	160 MHz
Output Level	15 dBm

6. Turn the HP 4195A on.
7. Adjust A40L10, and L16 (86.6 MHz BPF 3 ADJ) until the level at the center frequency (246.666 666 MHz) on the Network Analyzer is maximum, and the BPF frequency characteristics are similar to that shown in Figure 3-112.

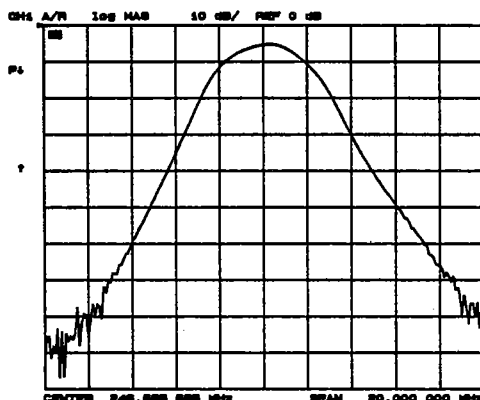

Figure 3-112. Source Third IF Converter 86.6 MHz BPF Adjustment Example

8. Reposition jumper A40J6 to the "N" position.
9. Replace the shield cover on the A40 board.

3-19-5. SECOND/THIRD IF CONVERTER GAIN ADJUSTMENT

This procedure adjusts the gain of the Source Second/Third IF Converter. Before performing this procedure, complete all of the Source Second/Third IF Converter band pass filter adjustments.

EQUIPMENT:

Spectrum Analyzer	HP 8568B	
Signal Generator	HP 8656B	
50Ω Termination	HP 909C Opt. 001	
BNC(m)-BNC(m) Cable, 30 cm	PN 8120-1838	
BNC(m)-BNC(m) Cable, 122 cm	PN 8120-1840	2 ea.
BNC(m)-BNC(m) Cable, 61 cm	PN 8120-1839	
N(f)-BNC(f) Adapter	PN 1250-1474	
N(m)-BNC(f) Adapter	PN 1250-1476	2 ea.
BNC(m)-SMB(f) Adapter	PN 1250-1236	

ADJUSTMENTS

BNC(m)-SMB(f) Cable, 122 cm
 Interconnect Cable, 9 pin
 Interconnect Cable, 50 pin

PN 85680-60093
 PN 16349-61601
 PN 16349-61602

2 ea.

SUMMARY:

MONITOR:

A40J4

ADJUSTMENT COMPONENT:

A40R14 (2ND IF GAIN ADJ)

TARGET:

1 dB \pm 0.1 dB less than the level at A40J2

PROCEDURE:

1. Connect the equipment as shown in Figure 3-113. See Figure 3-114 for the locations of A40J2, A40J4, and A40J7.

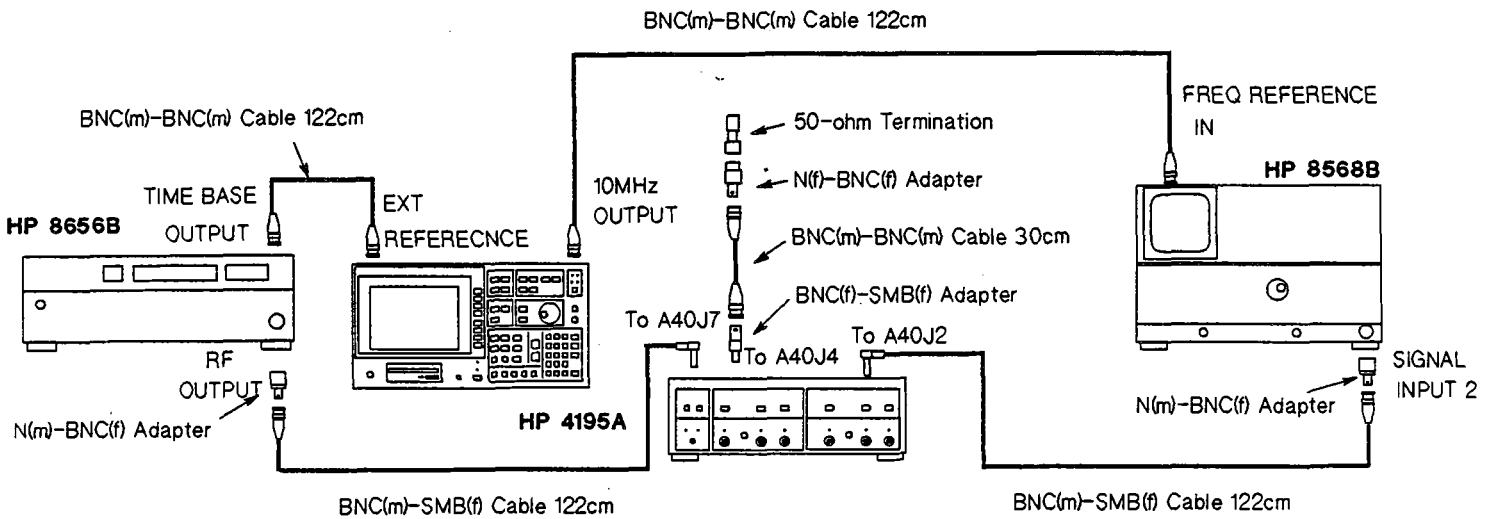

Figure 3-113. Receiver Second IF Converter Gain Adjustment Setup

ADJUSTMENTS

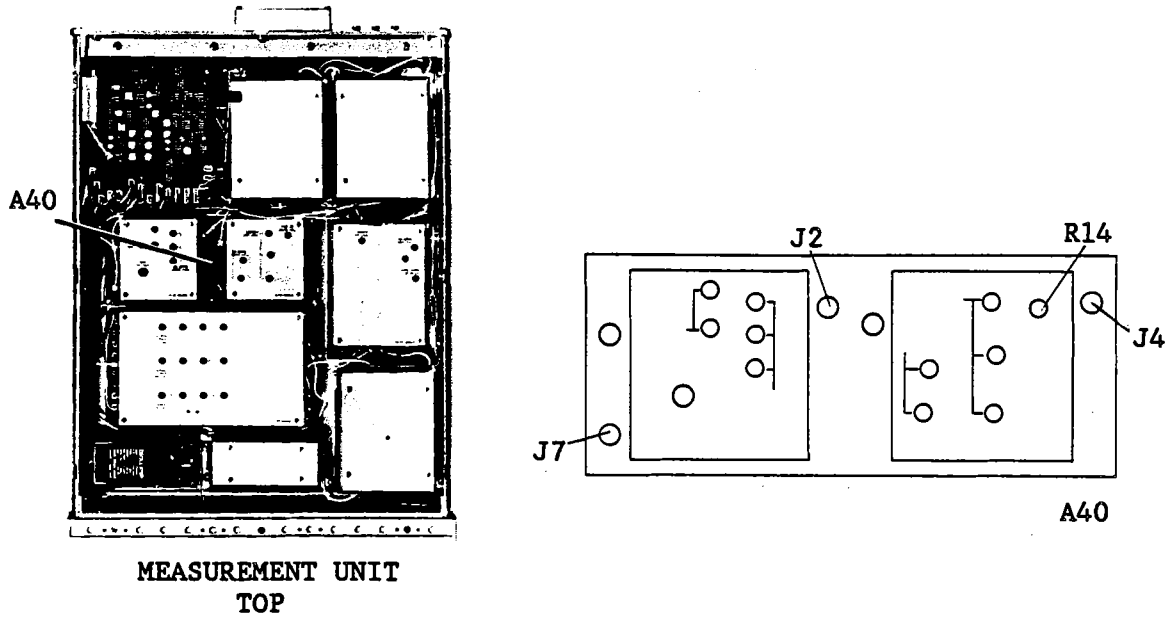

Figure 3-114. Second/Third IF Converter Gain Adjustment Locations

2. Set up the Signal Generator as follows.

Output Frequency	6.66666 MHz
Output Level	-13 dBm

3. Set up the Spectrum Analyzer as follows.

Center Frequency	86.667 MHz
Frequency Span	1 MHz

4. Turn the HP 4195A on.
5. Make a note of the peak level displayed by the Spectrum Analyzer.

NOTE

Confirm that the peak level on the Spectrum Analyzer display is $-7 \text{ dBm} \pm 1 \text{ dB}$. If it is not within range, repeat the procedures in paragraphs 3-19-1 through 3-19-4.

6. Disconnect the Spectrum Analyzer input cable and the 50Ω Termination from A40J2 and A40J4, respectively.
7. Connect the Spectrum Analyzer input cable to A40J4, and connect the 50Ω Termination to A40J2, respectively.
8. Change the Spectrum Analyzer Center Frequency to 246.667 MHz.
9. Adjust A40R14 until the peak level displayed by the Spectrum Analyzer is $1 \text{ dB} \pm 0.1 \text{ dB}$ less than the peak level measured in step 5. Refer to the following equation.

$$\text{Level(A40J4)} = \text{Level(A40J2)} - (1.0 \pm 0.1 \text{ dB})$$

ADJUSTMENTS

10. Reconnect coaxial cables (F), (B), and (N) to A40J2, A40J4, and A40J7, respectively.

ADJUSTMENTS

3-20. SOURCE FIRST IF CONVERTER ADJUSTMENTS

This procedure adjusts the 86.6 MHz Band Pass Filter and the source first IF converter gain.

3-20-1. FIRST IF CONVERTER BPF ADJUSTMENT

This procedure adjusts the 86.6 MHz Band Pass Filter of the source first IF converter.

EQUIPMENT:

Network Analyzer	HP 8753A	
Signal Generator	HP 8656B	
Mixer	HP 10514A	
Power Splitter	HP 11667A	2 ea.
N(m)-N(m) Cable, 61 cm	HP 11500B	3 ea.
BNC(m)-BNC(m) Cable, 61 cm	PN 8120-1839	
BNC(m)-BNC(m) Cable, 122 cm	PN 8120-1840	2 ea.
N(m)-BNC(f) Adapter	PN 1250-1476	3 ea.
BNC(f)-SMC(f) Adapter	PN 1250-0832	
Interconnect Cable, 9 pin	PN 16349-61601	
Interconnect Cable, 50 pin	PN 16349-61602	
Interconnect Cable, BNC(m)	PN 16349-61603	3 ea.
N(m)-N(m) Adapter	PN 1250-1475	2 ea.
3 dB Pad	HP 8491A Opt. 003	3 ea.
BNC(m)-N(f) Adapter	PN 1250-1477	3 ea.
Right Angle BNC Adapter	PN 1250-0076	
BNC(m)-SMB(f) Cable, 122 cm	PN 85680-60093	3 ea.

SUMMARY:

ADJUSTMENT COMPONENT: A43L4, L5 (86.6 MHz BPF ADJ)

TARGET: Center Frequency: 86.6 MHz
Insertion Loss: minimum

PROCEDURE:

1. Remove the shield cover from the A43 board. See Figure 3-116 for the locations of the A43 board.
2. Connect the equipment as shown in Figure 3-115.

ADJUSTMENTS

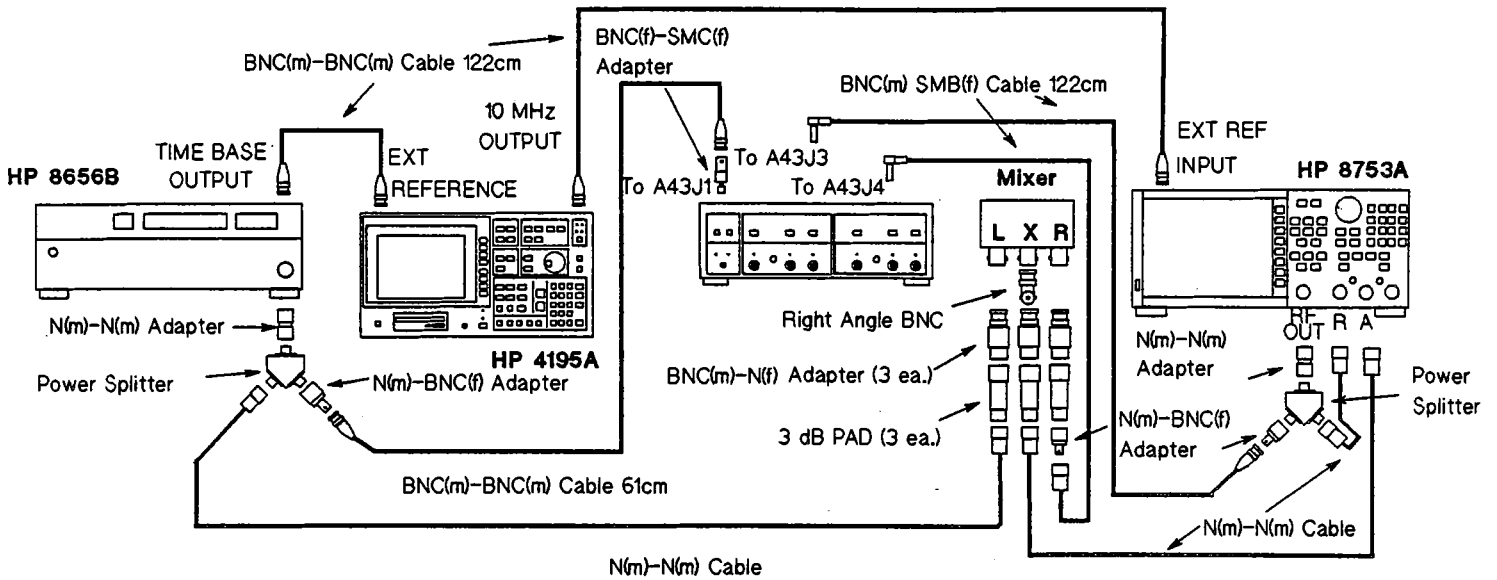

Figure 3-115. Source First IF Converter 86.6 MHz BPF Adjustment Setup

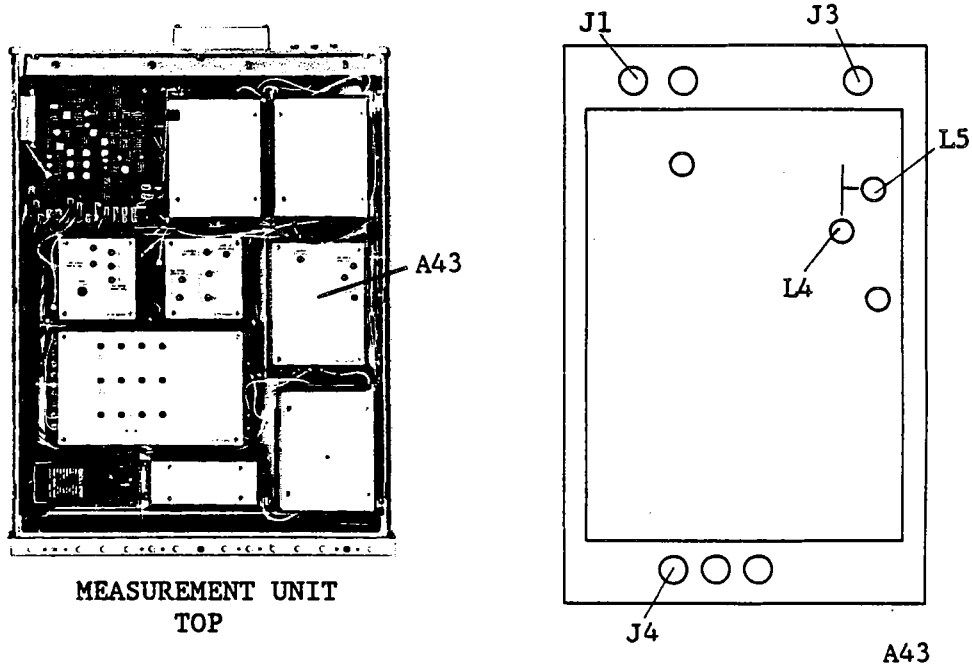

Figure 3-116. Source First IF Converter 86.6 MHz BPF Adjustment Locations

3. Reinstall the shield cover on the A43 board.

NOTE

The shield cover must be installed during this adjustment.

ADJUSTMENTS

4. Turn the HP 4195A on, and set it up as follows.

		COMMAND
CONFIGURATION	NETWORK	FNC1
INITIALIZE	PRESET	RST
CENTER FREQUENCY	150 MHz	CENTER= 150 M
FREQUENCY SPAN	0 Hz	SPAN= 0

5. Set up the Network Analyzer as follows.

Center Frequency	86.666 666 MHz
Frequency Span	100 MHz
Output Level	-10 dBm

6. Set up the Signal Generator as follows.

Output Frequency	233 MHz
Output Level	17 dBm

7. Vary the Signal Generator Output Frequency from 233 MHz to 413 MHz, so that the gain within the pass band displayed by the Network Analyzer is maximum.

8. Adjust A43L4 and L5 until the BPF center frequency is at 86.6 MHz, and the insertion loss is minimum as shown in Figure 3-117.

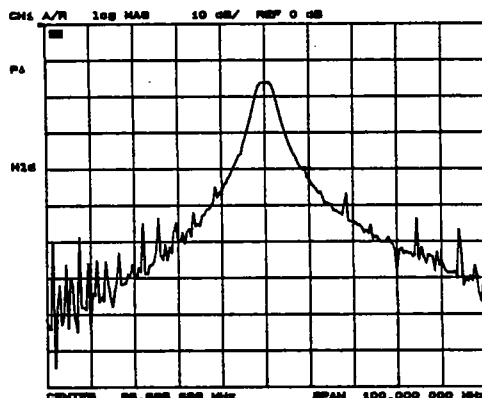

Figure 3-117. Example of Source First IF Converter 86.6 MHz BPF Adjustment

3-20-2. FIRST IF CONVERTER GAIN ADJUSTMENT

This procedure adjusts the gain of the Source First IF Converter. Before performing this procedure, complete the procedure in paragraph 3-20-1.

EQUIPMENT:

Power Meter	HP 436A	
Power Sensor	HP 8482A	
Interconnect Cable, 9 pin	PN 16349-61601	
Interconnect Cable, 50 pin	PN 16349-61602	
Interconnect Cable, BNC(m)	PN 16349-61603	3 ea.

ADJUSTMENTS

SUMMARY:

MONITOR:

OUTPUT R1

ADJUSTMENT COMPONENT:

A43R44 (10 Hz - 10 MHz GAIN ADJ)

TARGET:

Output Level at 5 MHz: ± 0.1 dB of output level at 50 MHz

PROCEDURE:

1. Position the Control and Measurement Units as shown in Figure 3-118, and connect the Interconnection Cables between them.
2. Connect the equipment as shown in Figure 3-118.

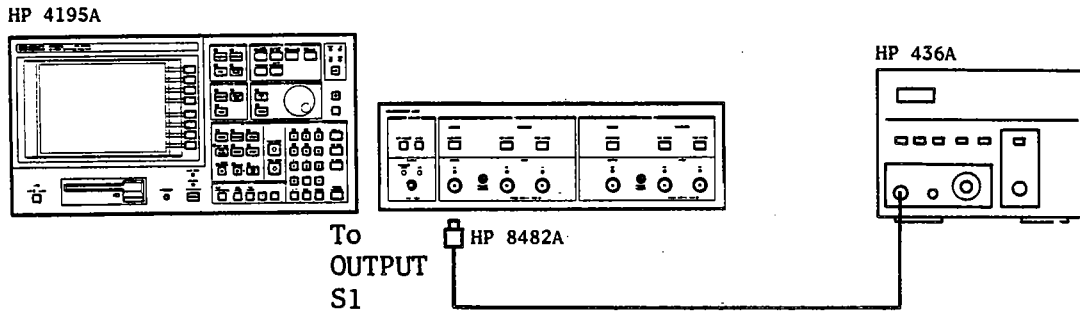

Figure 3-118. Source First IF Converter Gain Adjustment Setup

3. Connect the Power Sensor to the Meter, and calibrate the Meter to the Sensor.
4. Set up the HP 4195A as follows.

COMMAND

CONFIGURATION	NETWORK	FNC1
INITIALIZE	PRESET	RST
CENTER FREQUENCY	50 MHz	CENTER= 50 M
FREQUENCY SPAN	0 Hz	SPAN= 0

5. Make a note of the Meter reading.
6. Change the HP 4195A CENTER FREQUENCY to 5 MHz.
7. Adjust A43R44 (10 Hz-10 MHz GAIN ADJ) until the Meter reading is within ± 0.1 dB of the value obtained in step 5.

ADJUSTMENTS

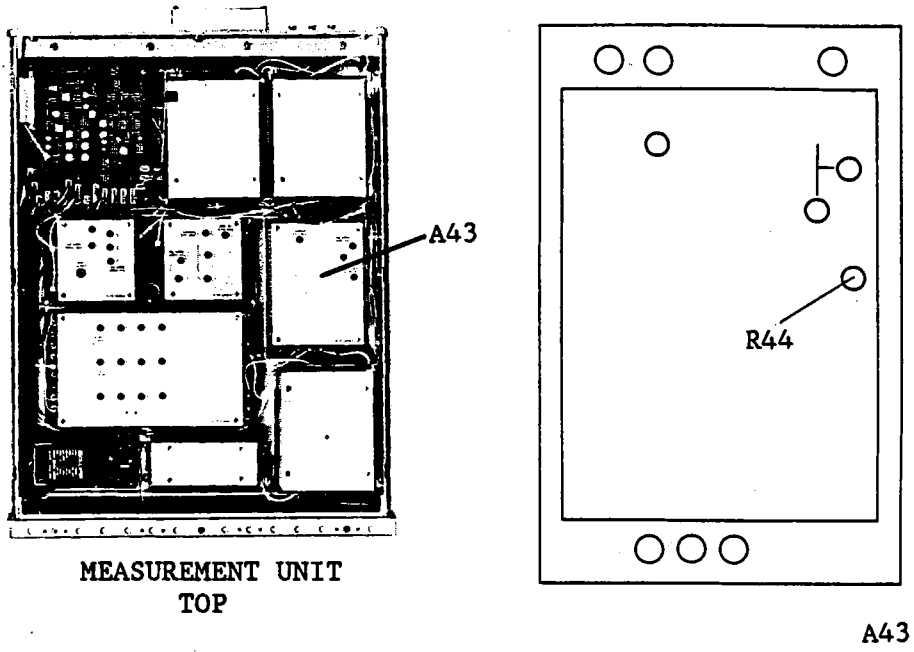

Figure 3-119. First IF Converter Gain Adjustment Locations

3-21. SOURCE OUTPUT FILTER ADJUSTMENTS

This procedure adjusts the three Voltage Tuned Band Pass Filters of the source output filter.

NOTE

If the HP 4195A firmware revision is 1.02 and below, use the procedure described in the Appendix A for this adjustment. The revision number can be obtained by entering the "REV?" command from the front panel keyboard.

EQUIPMENT:

Network Analyzer	HP 8753A	
Power Splitter	HP 11667A	
N(m)-N(m) Cable, 61cm	HP 11500B	
BNC(m)-BNC(m) Cable, 122 cm	PN 8120-1840	
N(m)-BNC(f) Adapter	PN 1250-1476	2 ea.
SMB(m)-SMB(m) Adapter	PN 1250-0813	
N(m)-N(m) Adapter	PN 1250-1475	
BNC(m)-SMB(f) Cable, 122 cm	PN 85680-60093	2 ea.
Interconnect Cable, 9 pin	PN 16349-61601	
Interconnect Cable, 50 pin	PN 16349-61602	
Interconnect Cable, BNC(m)	PN 16349-61603	3 ea.

3-21-1. 150 MHz - 225 MHz VOLTAGE TUNED BPF ADJUSTMENT

SUMMARY:

ADJUSTMENT COMPONENT: A44L1, L2, L3, L4 (150-225 MHz BPF ADJ)

TARGET: Gain at the maximum point: ≥ 12 dB
 -0.3 dB Band Width: ≥ 1 MHz

PROCEDURE:

1. Connect the equipment as shown in Figure 3-120.

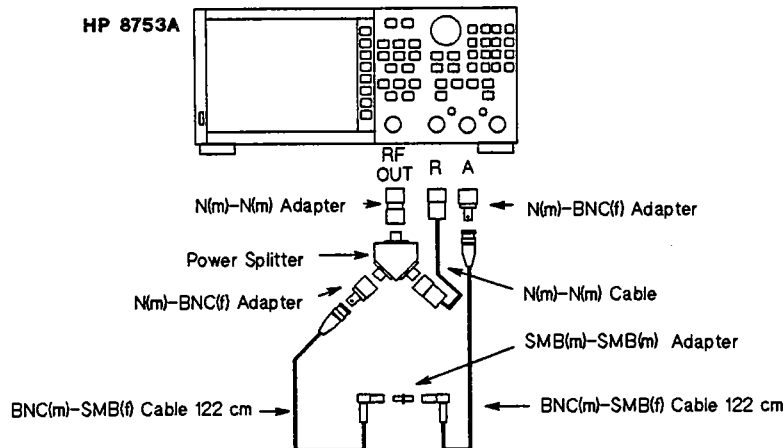

Figure 3-120. Source Output Filter Network Analyzer Setup

ADJUSTMENTS

2. Press the HP 8753A **PRESET** key.
3. Press the **MKR**, '**MARKER 1**', **MKR FCTN**, '**MKR SEARCH [OFF]**', '**TRACKING OFF**' (to ON), and '**MAX**' keys.
4. Press the **MKR**, '**Δ MODE MENU**', '**Δ REF = 1**', **MKR FCTN**, '**MKR SEARCH [MAX]**', '**WIDTH VALUE**', - (minus), . (period), **3**, **x1**, and '**WIDTHS OFF**' (to ON) keys.
5. Press the **SCALE REF**, **5**, **x1**, '**REFERENCE VALUE**', -, **1**, **0**, **x1** keys.
6. Set the **CENTER** frequency and frequency **SPAN** to 150 MHz and 10 MHz, respectively. Press the **CAL**, '**CALIBRATE MENU**', '**RESPONSE**', '**THRU**', '**DONE: RESPONSE**', and '**SAVE REG1**' (or '**RE-SAVE REG1**') keys.
7. Change the **CENTER** frequency to 225 MHz. Press the **CAL**, '**CALIBRATE MENU**', '**RESPONSE**', '**THRU**', '**DONE: RESPONSE**', and '**SAVE REG2**' (or '**RE-SAVE REG2**') keys.
8. Change the **CENTER** frequency to 180 MHz. Press the **CAL**, '**CALIBRATE MENU**', '**RESPONSE**', '**THRU**', '**DONE: RESPONSE**', and '**SAVE REG3**' (or '**RE-SAVE REG3**') keys.
9. Connect the equipment as shown in Figure 3-121. See Figure 3-122 for the locations of A44J1 and A44J2.

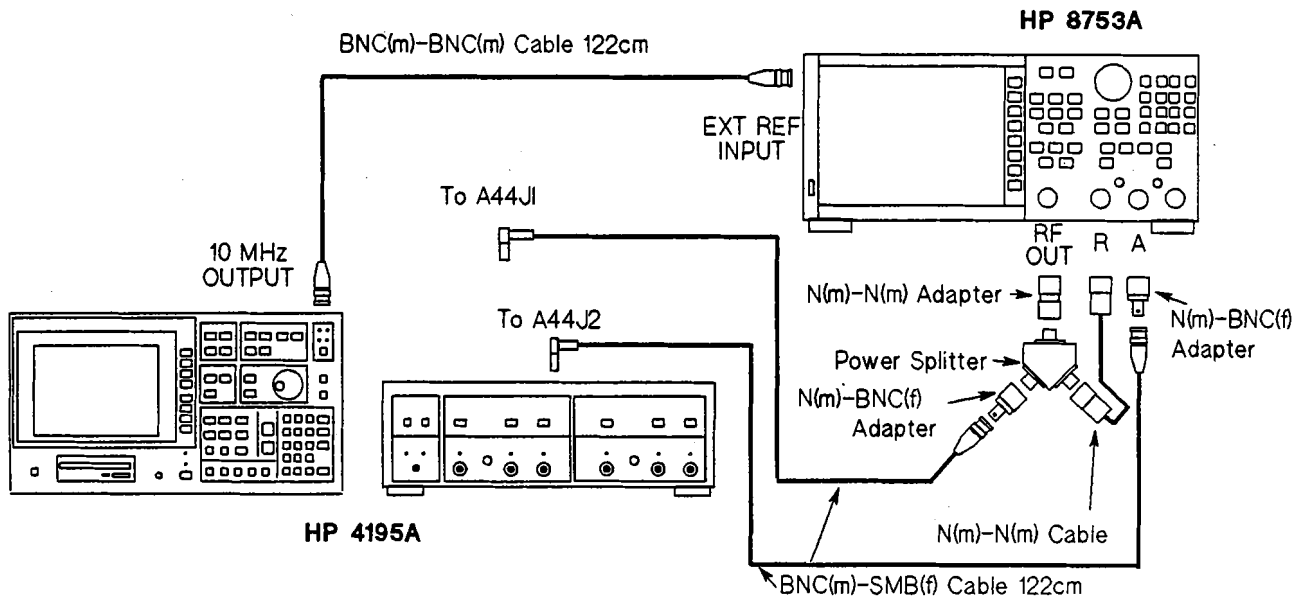

Figure 3-121. Source Output Filter Adjustment Setup

ADJUSTMENTS

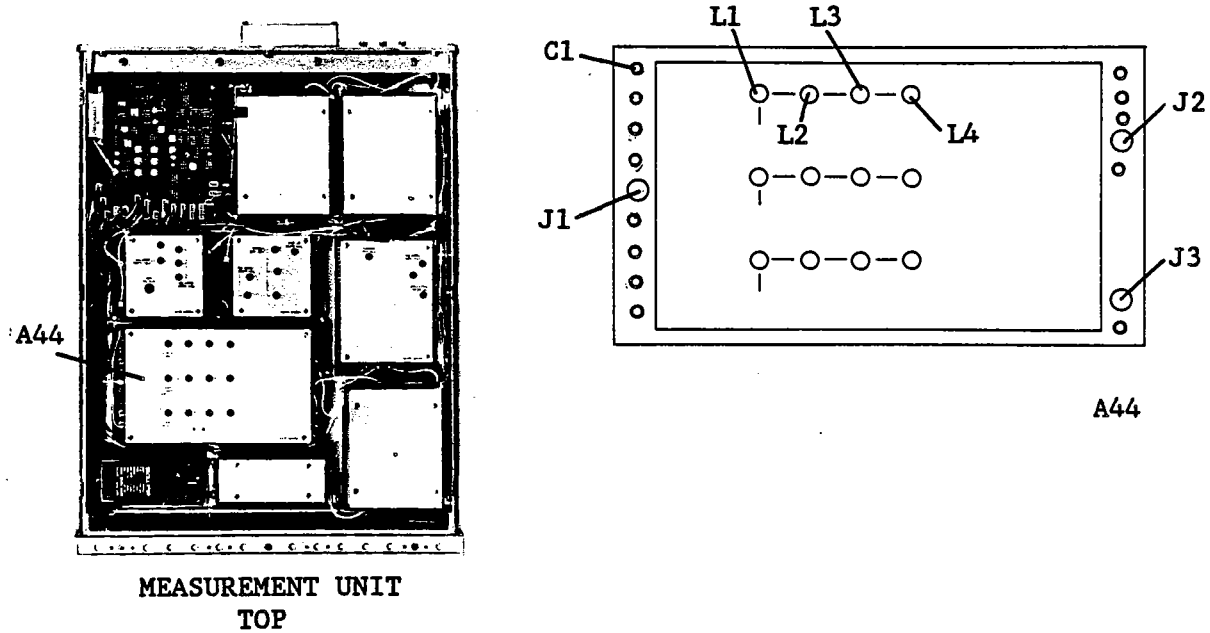

Figure 3-122. 150 - 225 MHz Voltage Tuned BPF Adjustment Locations

10. Turn the HP 4195A on.
11. Enter the "STSET" command using the following key strokes, to display the Service Function Menu.

Blue shiftkey, S, T, S, E, T ENTER/EXECUTE key
12. Enter the "STN=51" command using the following key strokes, to enter the Service Function No. 51 mode.

'TEST No.' softkey, 5, 1, ENTER/EXECUTE key
13. Press the 'START' softkey, and set its (display) FILTER to LOW, by repeatedly pressing the 'FILTER select' softkey.

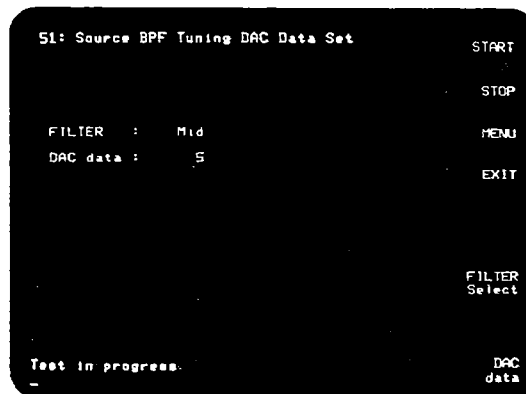

Figure 3-123. Service Function No. 51 Display

14. Press the HP 8753A **RECALL**, and **'RECALL REG 1'** keys.
15. Set the **DAC data** value to 3, using the following key strokes.

ADJUSTMENTS

'DAC data' softkey, 3, ENTER/EXECUTE key

16. Adjust A44L1, L2, L3, and L4 (150 MHz - 225 MHz BPF ADJ), until the following conditions are satisfied.

- | | |
|--|--------------------|
| a. Center Frequency of -0.3 dB Pass Band | 150 MHz to 151 MHz |
| b. -0.3 dB Bandwidth: | ≥1 MHz |
| c. Gain at the maximum point: | ≥12 dB |

NOTE

To measure gain for condition *c*, press the MKR, 'Δ MODE MENU' and 'Δ MODE OFF' keys of HP 8753A. To return measuring the conditions *a* and *b*, press the 'Δ MODE MENU', and 'Δ REF = 1' keys.

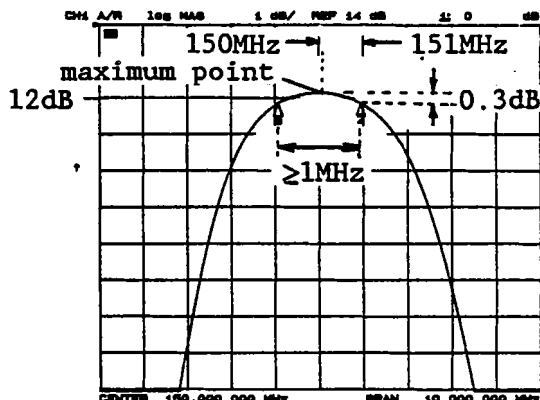

Figure 3-124. 150 - 225 MHz Voltage Tuned BPF Adjustment Example

17. Press the HP 8753A **RECALL**, and '**RECALL REG 2**' keys.

18. Set the displayed **DAC data** value to 200, using the following keystrokes.

'DAC data' softkey, 2, 0, 0, ENTER/EXECUTE key

19. Vary the **DAC data** value until the center frequency of the BPF characteristics displayed by the Network Analyzer is approximately 225 MHz.

20. Adjust A44L1, L2, L3, and L4 until the following conditions are satisfied.

- | | |
|---------------------------|--------|
| a. -0.3 dB Bandwidth: | ≥1 MHz |
| b. Gain at maximum point: | ≥12 dB |

21. Press the HP 8753A **RECALL**, and '**RECALL REG 3**' keys.

22. Set the **DAC data** value to 50, using the following key strokes.

'DAC data' softkey, 5, 0, ENTER/EXECUTE key

23. Vary the **DAC data** value until the center frequency of the BPF characteristics displayed by the Network Analyzer is approximately 180 MHz.

24. Adjust A44L1, L2, L3, and L4 until the following conditions are satisfied.

ADJUSTMENTS

- a. -0.3 dB Bandwidth: ≥1 MHz
- b. Gain at maximum point: ≥12 dB

25. Repeat steps 14 through 24, until all conditions of steps 16, 20, and 24 are satisfied without having to make further adjustment of A44L1, L2, L3, and L4.

3-21-2. 225 MHz - 340 MHz VOLTAGE TUNED BPF ADJUSTMENT

SUMMARY:

ADJUSTMENT COMPONENT: A44L15, L16, L17, L18 (225-340 MHz BPF ADJ)

TARGET: Gain at the maximum point: ≥12 dB
-0.3 dB Band Width: ≥1.5 MHz

PROCEDURE:

1. Connect the equipment as shown in Figure 3-120.
2. Press the HP 8753A **PRESET** key.
3. Press the **MKR**, **'MARKER 1'**, **MKR FCTN**, **'MKR SEARCH [OFF]'**, **'TRACKING OFF'** (to ON), and **'MAX'** keys.
4. Press the **MKR**, **'Δ MODE MENU'**, **'Δ REF = 1'**, **MKR FCTN**, **'MKR SEARCH [MAX]'**, **'WIDTH VALUE'**, **- (minus)**, **. (period)**, **3**, **x1**, and **'WIDTHS OFF'** (to ON) keys.
5. Press the **SCALE REF**, **5**, **x1**, **'REFERENCE VALUE'**, **-**, **1**, **0**, **x1** keys.
6. Set the **CENTER** frequency and frequency **SPAN** to 225 MHz and 20 MHz, respectively. Press the **CAL**, **'CALIBRATE MENU'**, **'RESPONSE'**, **'THRU'**, **'DONE: RESPONSE'**, and **'SAVE REG1'** (or **'RE-SAVE REG1'**) keys.
7. Change the **CENTER** frequency to 340 MHz. Press the **CAL**, **'CALIBRATE MENU'**, **'RESPONSE'**, **'THRU'**, **'DONE: RESPONSE'**, and **'SAVE REG2'** (or **'RE-SAVE REG2'**) keys.
8. Change the **CENTER** frequency to 285 MHz. Press the **CAL**, **'CALIBRATE MENU'**, **'RESPONSE'**, **'THRU'**, **'DONE: RESPONSE'**, and **'SAVE REG3'** (or **'RE-SAVE REG3'**) keys.
9. Connect the equipment as shown in Figure 3-121. See Figure 3-125 for A44J1 and A44J2 locations.

ADJUSTMENTS

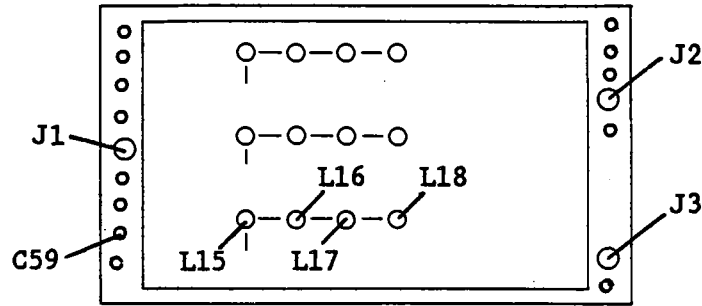

A44

Figure 3-125. 225 MHz - 340 MHz Voltage Tuned BPF Adjustment Locations

10. Turn the HP 4195A on.
11. Enter the "STSET" command using the following key strokes, to display the Service Function Menu.

Blue shiftkey, S, T, S, E, T ENTER/EXECUTE key
12. Enter the "STN=51" command using the following key strokes, to enter the Service Function No. 51 mode.

'TEST No.' softkey, 5, 1, ENTER/EXECUTE key
13. Press the 'START' softkey, and set its (display) FILTER to MID, by repeatedly pressing the 'FILTER select' softkey.
14. Press the HP 8753A RECALL, and 'RECALL REG 1' keys.
15. Set the DAC data value to 3, using the following key strokes.

'DAC data' softkey, 3, ENTER/EXECUTE key
16. Adjust A44L15, L16, L17, and L18 (225 MHz - 340 MHz BPF ADJ), until the following conditions are satisfied.

a. Center Frequency of -0.3 dB Pass Band	225 MHz to 226 MHz
b. -0.3 dB Bandwidth:	≥1.5 MHz
c. Gain at the maximum point:	≥12 dB

NOTE

To measure gain for condition *c*, press the MKR, 'Δ MODE MENU' and 'Δ MODE OFF' keys of HP 8753A. To return measuring the conditions *a* and *b*, press the 'Δ MODE MENU', and 'Δ REF = 1' keys.

ADJUSTMENTS

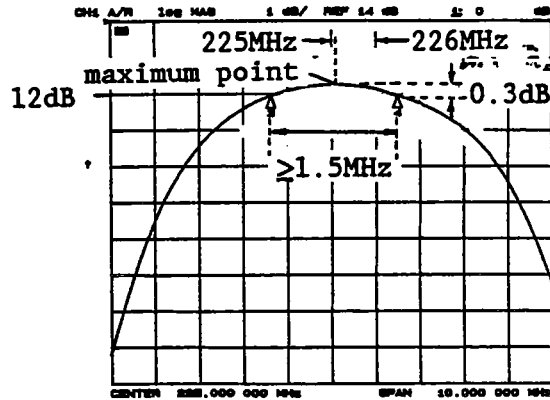

Figure 3-126. 225 - 340 MHz Voltage Tuned BPF Adjustment Example

17. Press the HP 8753A **RECALL**, and '**RECALL REG 2**' keys.
18. Set the displayed **DAC data** value to 200, using the following keystrokes.
 '**DAC data**' softkey, **2, 0, 0, ENTER/EXECUTE** key
19. Vary the **DAC data** value until the center frequency of the BPF characteristics displayed by the Network Analyzer is approximately 340 MHz.
20. Adjust **A44L15, L16, L17, and L18** until the following conditions are satisfied.

a. -0.3 dB Bandwidth:	≥1.5 MHz
b. Gain at maximum point:	≥12 dB
21. Press the HP 8753A **RECALL**, and '**RECALL REG 3**' keys.
22. Set the **DAC data** value to 50, using the following key strokes.
 '**DAC data**' softkey, **5, 0, ENTER/EXECUTE** key
23. Vary the **DAC data** value until the center frequency of the BPF characteristics displayed by the Network Analyzer is approximately 285 MHz.
24. Adjust **A44L15, L16, L17, and L18** until the following conditions are satisfied.

a. -0.3 dB Bandwidth:	≥1.5 MHz
b. Gain at maximum point:	≥12 dB
25. Repeat steps 14 through 24, until all conditions of steps 15, 19, and 24 are satisfied without having to make further adjustment of **A44L15, L16, L17, and L18**.

3-21-3. 340 MHz - 500 MHz VOLTAGE TUNED BPF ADJUSTMENT

SUMMARY:

ADJUSTMENT COMPONENT:

A44L6, L7, L8, L9 (340-500 MHz BPF ADJ)

TARGET:

ADJUSTMENTS

Gain at the maximum point:	≥12 dB
-0.3 dB Band Width:	≥2 MHz

PROCEDURE:

1. Connect the equipment as shown in Figure 3-120.
2. Press the HP 8753A PRESET key.
3. Press the MKR, 'MARKER 1', MKR FCTN, 'MKR SEARCH [OFF]', 'TRACKING OFF' (to ON), and 'MAX' keys.
4. Press the MKR, 'Δ MODE MENU', 'Δ REF = 1', MKR FCTN, 'MKR SEARCH [MAX]', 'WIDTH VALUE', - (minus), . (period), 3, x1, and 'WIDTHS OFF' (to ON) keys.
5. Press the SCALE REF, 5, x1, 'REFERENCE VALUE', -, 1, 0, x1 keys.
6. Set the CENTER frequency and frequency SPAN to 340 MHz and 10 MHz, respectively. Press the CAL, 'CALIBRATE MENU', 'RESPONSE', 'THRU', 'DONE: RESPONSE', and 'SAVE REG1' (or 'RE-SAVE REG1') keys.
7. Change the CENTER frequency to 500 MHz. Press the CAL, 'CALIBRATE MENU', 'RESPONSE', 'THRU', 'DONE: RESPONSE', and 'SAVE REG2' (or 'RE-SAVE REG2') keys.
8. Change the CENTER frequency to 420 MHz. Press the CAL, 'CALIBRATE MENU', 'RESPONSE', 'THRU', 'DONE: RESPONSE', and 'SAVE REG3' (or 'RE-SAVE REG3') keys.
9. Connect the equipment as shown in Figure 3-121. See Figure 3-127 for A44J1 and A44J2 locations.
10. Turn the HP 4195A on.

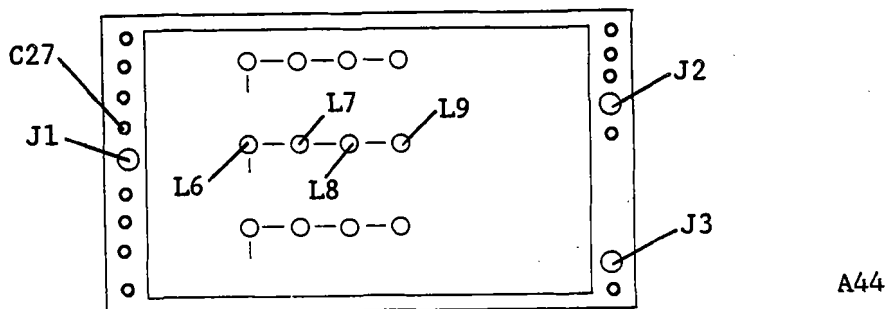

Figure 3-127. 340 - 500 MHz Voltage Tuned BPF Adjustment Locations

11. Enter the "STSET" command using the following key strokes, to display the Service Function Menu.

Blue shiftkey, S, T, S, E, T ENTER/EXECUTE key

12. Enter the "STN=51" command using the following key strokes, to enter the Service Function No. 51 mode.

'TEST No.' softkey, 5, 1, ENTER/EXECUTE key

ADJUSTMENTS

13. Press the 'START' softkey, and set the display FILTER to HIGH, by repeatedly pressing the 'FILTER select' softkey.
14. Press the HP 8753A RECALL, and 'RECALL REG 1' keys.
15. Set the DAC data value to 3, using the following key strokes.

'DAC data' softkey, 3, ENTER/EXECUTE key

16. Adjust A44L6, L7, L8, and L9 (340 MHz - 500 MHz BPF ADJ), until the following conditions are satisfied.

- | | |
|--|--------------------|
| a. Center Frequency of -0.3 dB Pass Band | 340 MHz to 341 MHz |
| b. -0.3 dB Bandwidth: | ≥ 2 MHz |
| c. Gain at the maximum point: | ≥ 12 dB |

NOTE

To measure gain for condition *c*, press the MKR, 'Δ MODE MENU' and 'Δ MODE OFF' keys of HP 8753A. To return measuring the conditions *a* and *b*, press the 'Δ MODE MENU', and 'Δ REF = 1' keys.

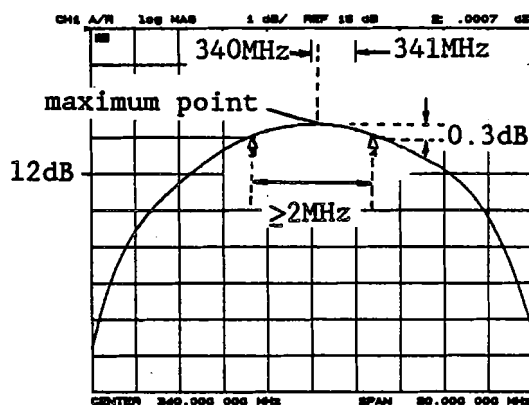

Figure 3-128. 340 - 500 MHz Voltage Tuned BPF Adjustment Example

17. Press the HP 8753A RECALL, and 'RECALL REG 2' keys.
18. Set the displayed DAC data value to 200, using the following keystrokes.

'DAC data' softkey, 2, 0, 0, ENTER/EXECUTE key
19. Vary the DAC data value until the center frequency of the BPF characteristics displayed by the Network Analyzer is approximately 500 MHz.
20. Adjust A44L6, L7, L8, and L9 until the following conditions are satisfied.

a. -0.3 dB Bandwidth:	≥ 2 MHz
b. Gain at maximum point:	≥ 12 dB
21. Press the HP 8753A RECALL, and 'RECALL REG 3' keys.
22. Set the DAC data value to 50, using the following key strokes.

'DAC data' softkey, 5, 0, ENTER/EXECUTE key

ADJUSTMENTS

23. Vary the DAC data value until the center frequency of the BPF characteristics displayed by the Network Analyzer is approximately 420 MHz.
24. Adjust A44L6, L7, L8, and L9 until the following conditions are satisfied.
 - a. -0.3 dB Bandwidth: ≥ 2 MHz
 - b. Gain at maximum point: ≥ 12 dB
25. Repeat steps 14 through 24, until all conditions of steps 16, 20, and 24 are satisfied without having to make further adjustment of A44L6, L7, L8, and L9.

3-22. SOURCE POWER AMPLIFIER ADJUSTMENTS

This procedure adjusts **SOURCE S1** and **S2** power amplifier DC offsets and gains.

3-22-1. POWER AMPLIFIER DC OFFSET ADJUSTMENTS

This procedure adjusts the **SOURCE S1** and **SOURCE S2** power amplifier DC offsets.

EQUIPMENT:

Digitizing Oscilloscope	HP 54111D	
N(m)-BNC(f) Adapter	PN 1250-1476	
BNC(m)-BNC(m) cable, 61 cm	PN 8120-1839	
Interconnect Cable, 9 pin	PN 16349-61601	
Interconnect Cable, 50 pin	PN 16349-61602	
Interconnect Cable, BNC(m)	PN 16349-61603	3 ea.

SUMMARY:

MONITOR:		(1) OUTPUT S1 (2) OUTPUT S2
ADJUSTMENT COMPONENT:		(1) A46R36 (2) A45R36
TARGET:	Peak to Peak Voltage:	< 10 mVpp

PROCEDURE:

1. Position the Control and Measurement Units as shown in Figure 3-129, and connect the Interconnection Cables between both units.
2. Connect the equipment as shown in Figure 3-129.

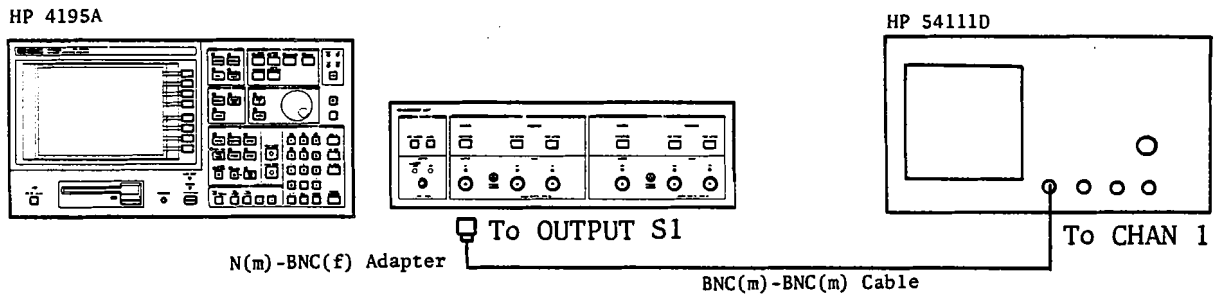

Figure 3-129. Power Amplifier DC Offset Adjustment Setup

3. Remove the A45 board. Remove the shield cover to gain access to both the A45 and A46 boards.
4. Place A45 circuit side up. Do not place the board on a conductive surface.
5. Disconnect coaxial cables (B) from A45J2 and A46J2.

ADJUSTMENTS

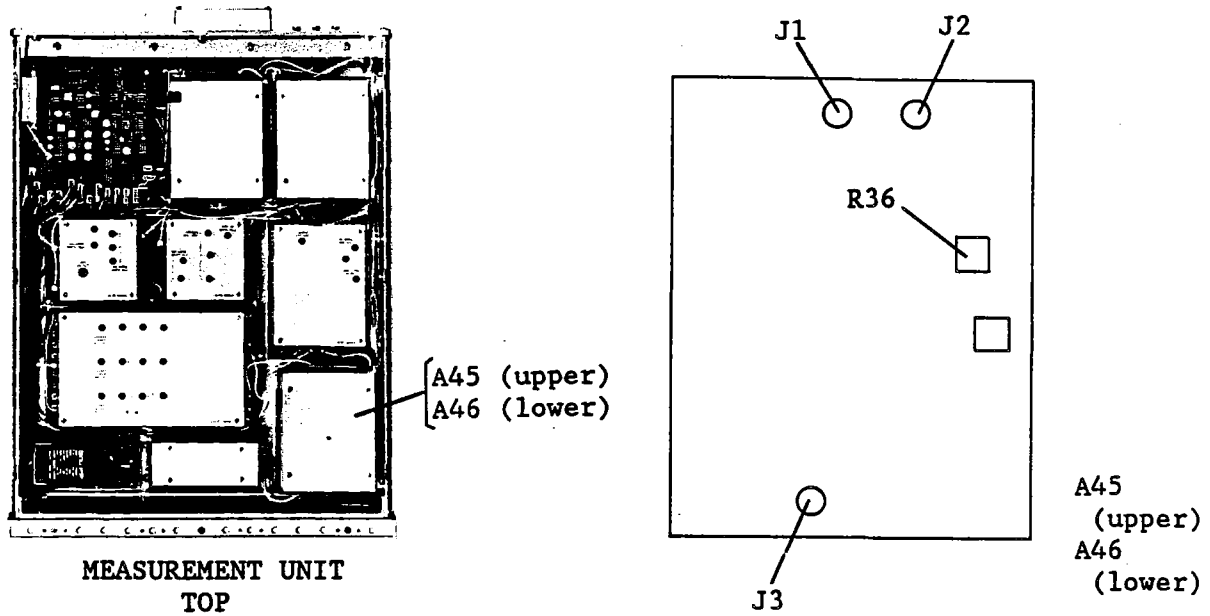

Figure 3-130. Power Amplifier DC Offset Adjustment Locations

6. Turn the HP 4195A on, and enter the "STSET" command from the Keyboard Input Line using the following key strokes.

Blue shiftkey, S, T, S, E, T, ENTER/EXECUTE key

7. Enter the "STN=17" command using the following key strokes.

'TEST No.' softkey, 1, 7, ENTER/EXECUTE key

8. Press the 'START' softkey.

9. Adjust A46R36 until the peak to peak voltage displayed by the Oscilloscope is < 10 mV as shown in Figure 3-131.

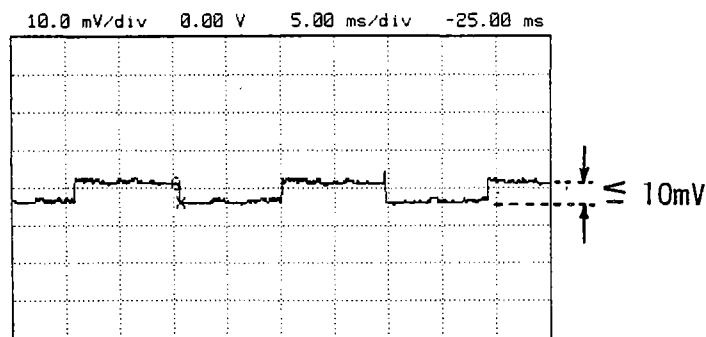

Figure 3-131. DC Offset Adjustment Example

10. Change connection of the Oscilloscope input cable to **OUTPUT S2**.
11. Adjust A45R36 until the peak to peak voltage displayed by the Oscilloscope is < 10 mV as shown in Figure 3-131.
12. Reconnect coaxial cables (B) to A45J2 and A46J2.

ADJUSTMENTS

3-22-2. POWER AMPLIFIER GAIN ADJUSTMENTS

This procedure adjusts power amplitude gain of SOURCE S1 and SOURCE S2.

EQUIPMENT:

Power Meter	HP 436A	
Power Sensor	HP 8482A	
Interconnect Cable, 9 pin	PN 16349-61601	
Interconnect Cable, 50 pin	PN 16349-61602	
Interconnect Cable, BNC(m)	PN 16349-61603	3 ea.

SUMMARY:

MONITOR:

- (1) OUTPUT S1
- (2) OUTPUT S2

ADJUSTMENT COMPONENT:

- (1) A46R39
- (2) A45R39

TARGET: Output Level at 100 kHz: ± 0.1 dB of 5 MHz output level

PROCEDURE:

1. Place the Control and Measurement Units as shown in Figure 3-132, and connect the Interconnection Cables between both units.

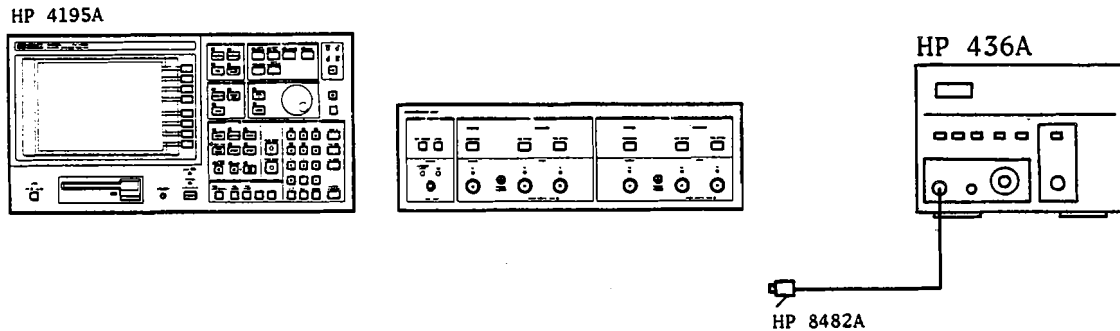

Figure 3-132. Power Amplifier Gain Adjustment Setup

2. Remove the A45 board. Remove the shield cover to gain access to both the A45 and A46 boards.
3. Place A45 circuit side up. Do not place the board on a conductive surface.
4. Connect the Sensor to the Power Meter, and calibrate the Meter to the Sensor.
5. Turn the HP 4195A on, and set it up as follows.

COMMAND

CONFIGURATION
INITIALIZE

NETWORK
PRESET

FNC1
RST

ADJUSTMENTS

CENTER FREQUENCY
FREQUENCY SPAN

5 MHz
0 Hz

CENTER= 5 M
SPAN= 0

6. Connect the Sensor to **OUTPUT S1**.
7. Make a note of the Meter reading.
8. Change the HP 4195A CENTER FREQUENCY to 100 kHz.
9. Adjust **A46R39** until the Meter reads ± 0.1 dB of the value noted in step 7.

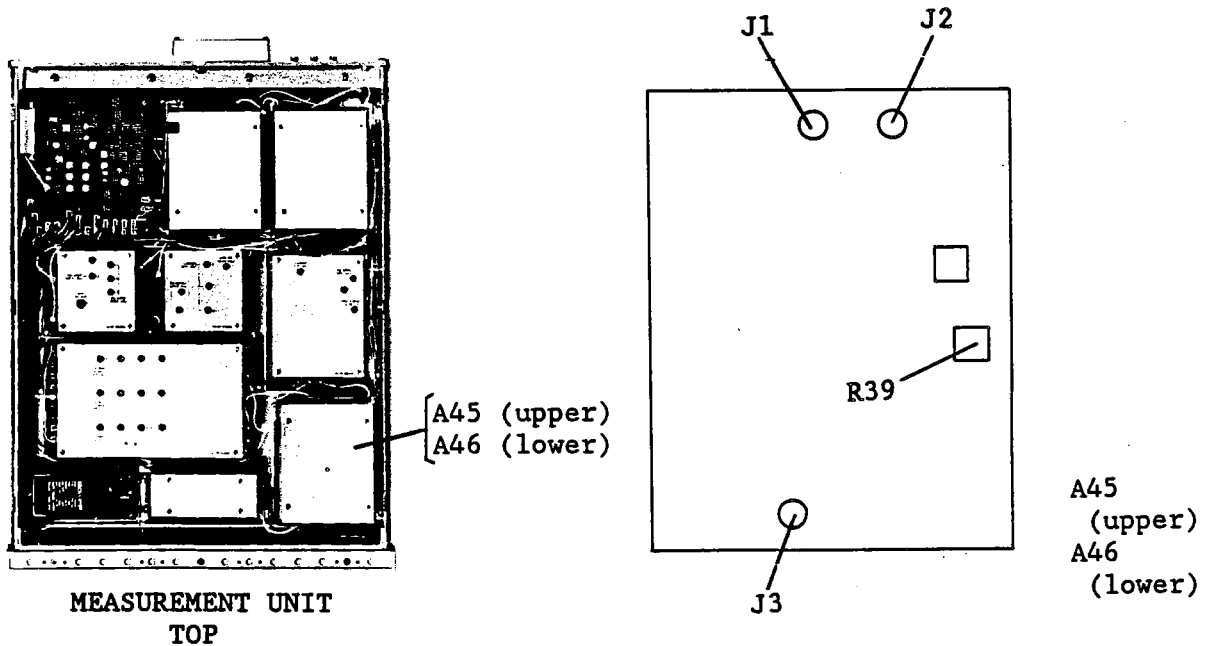

Figure 3-133. Power Amplifier Gain Adjustment Locations

10. Set up the HP 4195A as follows.

COMMAND

CONFIGURATION
INITIALIZE
INPUT PORT
CENTER FREQUENCY
FREQUENCY SPAN

NETWORK
PRESET
T2/R2
5 MHz
0 Hz

FNC1
RST
PORT5
CENTER= 5 MHZ
SPAN= 0 HZ

11. Connect the Sensor to **OUTPUT S2**.
12. Make a note of the Meter reading.
13. Change the HP 4195A CENTER FREQUENCY to 100 kHz.
14. Adjust **A45R39** until the Meter reads within ± 0.1 dB of the value noted in step 12.
15. Reinstall the A45 board into the Measurement Unit.

3-23. SOURCE DC BIAS FULL-SCALE ADJUSTMENTS

This procedure adjusts the full-scale positive and negative DC bias output.

EQUIPMENT:

Digital Voltmeter	HP 3456A	
BNC(m)-BNC(m) Cable, 61 cm	PN 8120-1839	
BNC(f)-Dual Banana Plug Adapter	PN 1251-2277	
Interconnect Cable, 9 pin	PN 16349-61601	
Interconnect Cable, 50 pin	PN 16349-61602	
Interconnect Cable, BNC(m)	PN 16349-61603	3 ea.

SUMMARY:

MONITOR:		DC SOURCE
ADJUSTMENT COMPONENT:	Positive full-scale:	A51R18
	Negative full-scale:	A51R11
TARGET:	Positive full-scale:	+40 V \pm 3 mV
	Negative full-scale:	-40 V \pm 3 mV

PROCEDURE:

1. Position the Control and Measurement Units as shown in Figure 3-134, and connect the Interconnection cables between both units.
2. Connect the equipment as shown in Figure 3-134.

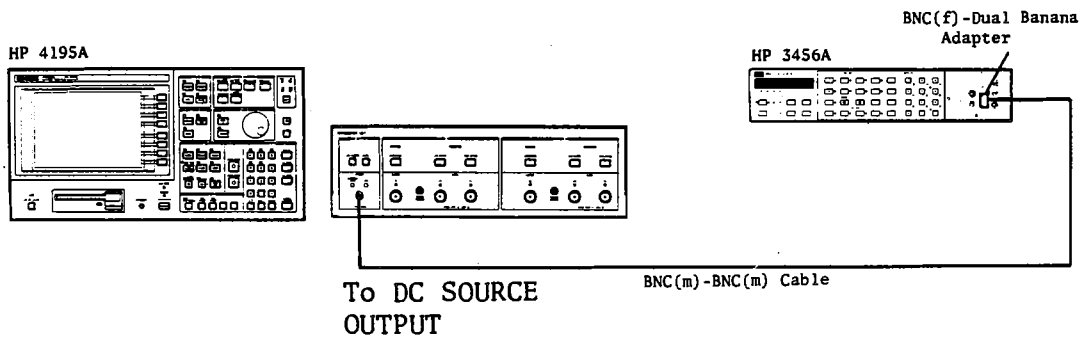

Figure 3-134. DC Bias Full-scale Adjustment Setup

3. Set the DC bias to 40 V using the following key strokes.

DC SOURCE LEVEL key, **4**, **0**, **ENTER/EXECUTE** key

4. Adjust A51R18 until the Voltmeter reads +40 V \pm 3 mV.

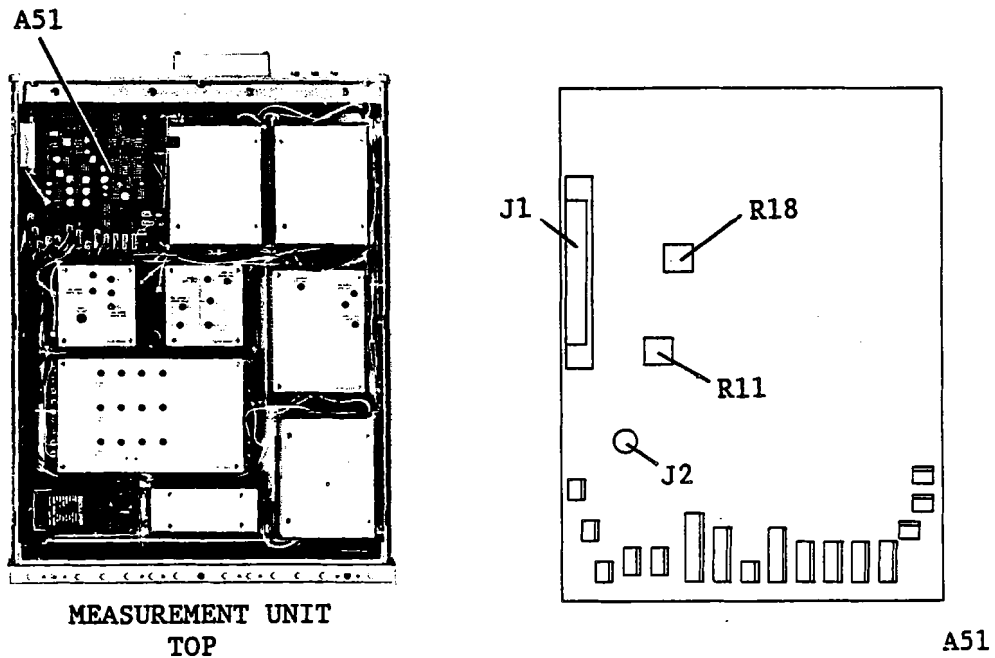

Figure 3-135. DC Bias Full-Scale Adjustment Locations

5. Set the DC bias to -40 V by pressing the following key strokes.

DC SOURCE LEVEL key, -, 4, 0, **ENTER/EXECUTE** key

6. Adjust A51R11 until the Voltmeter reads -40 V \pm 3 mV.
7. Turn off the DC bias by pressing the **DC SOURCE OFF/ABORT** key.

3-24. PHASE DETECTOR TRACKING ADJUSTMENTS

This procedure minimizes the GAIN and PHASE difference between the 0°/90° phase detectors.

EQUIPMENT:

N(m)-N(m) Cable, 61 cm

HP 11500B

SUMMARY:

MONITOR:

Service Function No. 10 display

ADJUSTMENT COMPONENT:

A9R58 (GAIN ADJ), A9R75 (PHASE ADJ)

TARGET:

Gain: 1.0000 ±0.0004
Phase: 1.0000 ±0.0004

PROCEDURE:

1. Connect the equipment as shown in Figure 3-136

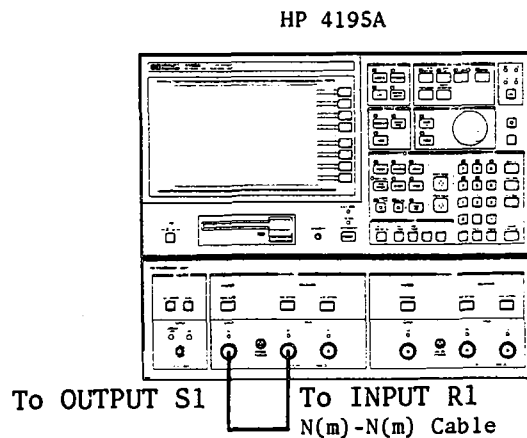

Figure 3-136. Phase Detector Tracking Adjustment Setup

2. Enter the "STSET" command from the Keyboard Input Line, using the following key strokes to display the Service Function Menu.

Blue shiftkey, S, T, S, E, T, ENTER/EXECUTE key

3. Enter the "STN=10" command, using the following key strokes.

'TEST No.' softkey, 1, 0, ENTER/EXECUTE key

4. Press the 'START' softkey.

The Amplitude, Gain, and Phase are continuously measured and displayed, as shown in Figure 3-137.

ADJUSTMENTS

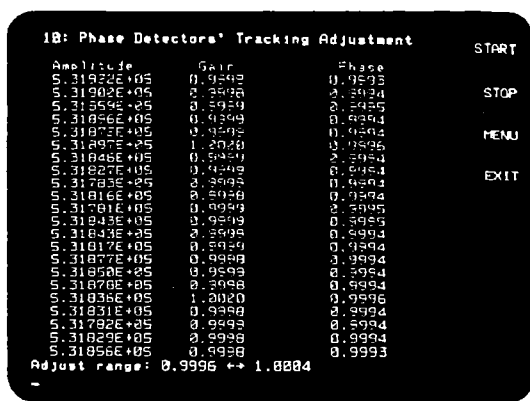

Figure 3-137. Phase Detector Tracking Adjustment Display

- Adjust A9R58 (GAIN ADJ) and A9R75 (PHASE ADJ) until the displayed values of Gain and Phase are 1.0000 ± 0.0004 . Read the bottom column values.

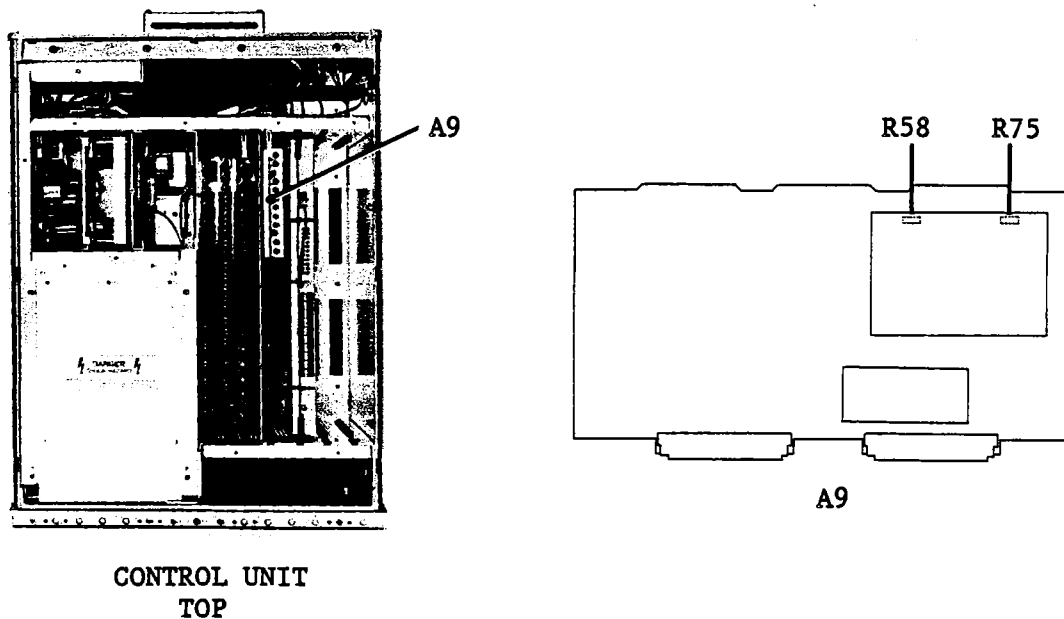

Figure 3-138. Phase Detector Tracking Adjustment Location

3-25. UPDATING CALIBRATION DATA

The following paragraphs describe the parts of HP 4195A adjustment which requires external computer control. Some of them are to update calibration data stored in the EEPROM (A8U17), and others adjust variable resistors under supervisory control of a computer program.

The HP 4195A ADJUSTMENT PROGRAM software disk used here is available by part number 04195-65009, but is not furnished with HP 4195A instruments nor any HP 4195A manuals.

NOTE

All the previously described adjustments must be completed before performing the following adjustments.

3-25-1. HP-IB CONTROLLER PREPARATION

This paragraph describes how to set up equipment and how to operate the software.

EQUIPMENT:

Desktop Computer (Controller)	HP 9826 ¹	
HP-IB Cable	HP 10833A/B/C	3 ea.
HP 4195A Adjustment Program	PN 04195-65009	
Signal Generator	HP 8656B ²	
Power Meter	HP 436A Opt. 022 ³	
Power Sensor	HP 8482A	
Attenuator	HP 8496A/G Opt. 001 ⁴	

- Note:
- ¹: HP 9000 Series 200 model 226 or 236 can be used.
 - ²: An HP 8642B can be used instead of the HP 8656B.
 - ³: An HP 438A can be used instead of the HP 436A Opt. 022.
 - ⁴: The 30 dB insertion loss must be calibrated at 50 MHz.

PROCEDURE:

1. Connect HP-IB Cables between the controller, HP 4195A, Signal Generator, and Power Meter.

NOTE

Be sure to use furnished rear panel interconnection cables (shorter). Do not adjust using longer cables.

2. Turn the test equipment on.
3. Calibrate the Power Meter to the Power Sensor.

ADJUSTMENTS

NOTE

If the HP 438A Power Meter is used, connect the Sensor to the HP 438A A connector.

4. Turn the controller on, and boot up HP BASIC.
5. Load the binary files as necessary for the language version you are using, as shown in Table 3-4.

Table 3-4. Binary Files for the HP 4195A Adjustment Program

HP BASIC Version	Binary Files
BASIC 2.0	AP2_1, GRAPH2_1
BASIC 3.0 or later version	HPIB, ERR, GRAPH, IO, KBD, MAT, GRAPHX

NOTE

To run the Adjustment Program, it is necessary to have enough working space in memory (61,802 bytes of RAM after BASIC and the binary files are loaded).

6. Insert the Adjustment Program (PN 04195-65009) disk into the flexible disk drive.
7. Load the program for adjustments The program file name is:

"ADJ_HP 4195A"

Program Execution:

1. Press the **RUN** key to start the program.

After a short time, the message "Change jumper A8W2 to its lowermost position." will be displayed.

2. Turn the HP 4195A off.
3. Move jumper A8W2 to the EEPROM write enable (lowermost) position, as shown in Figure 3-139, to write-enable the EEPROM so that the calibration data can be written to it.

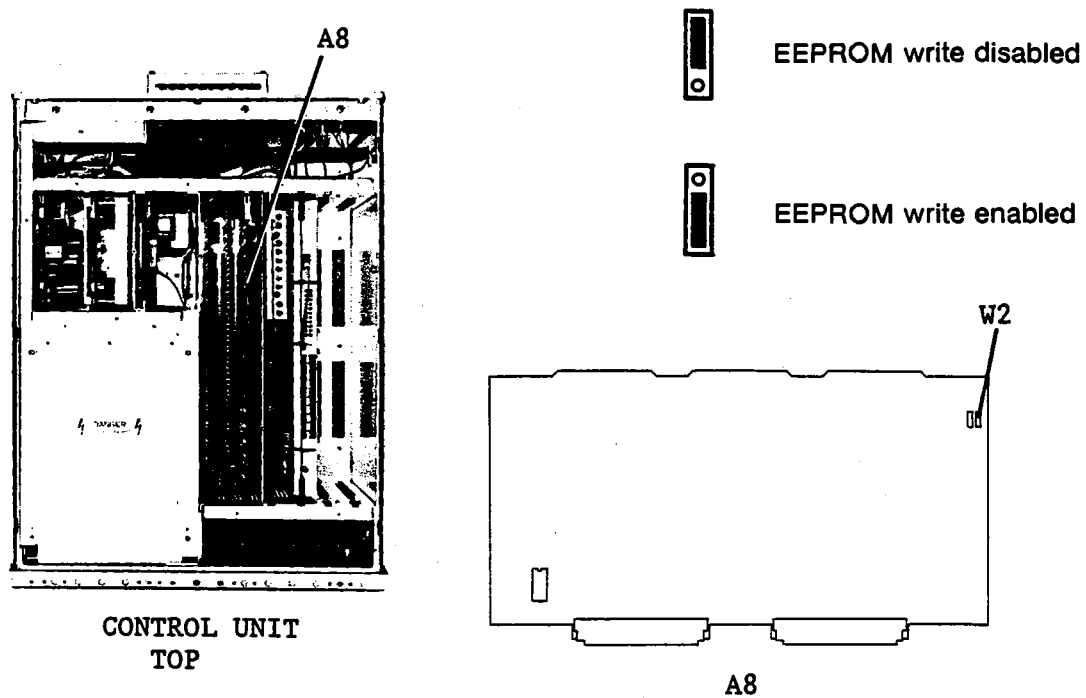

Figure 3-139. EEPROM Write Enable Jumper Location

4. Turn the HP 4195A on.
5. Wait until the HP 4195A starts the sweep measurement, then press key k8 'READY'.
6. Select model numbers for Signal Generator and Power Meter so that they match your setup. Also register HP-IB addresses for the Signal Generator, the Power Meter, and the HP 4195A.

Press key k1 'Next Sig Gen' to select Signal Generator model number. Displayed model number will toggle between HP 8656B and HP 8642B.

Press key k2 'Adrs Sig Gen' to enter the Signal Generator's HP-IB address. The controller will prompt you to enter the address.

Press key k3 'Next Pwr Mtr' to select Power Meter model number. The displayed model number will toggle between HP 436A and HP 438B.

Press key k4 'Adrs Pwr Mtr' to enter Power Meter's HP-IB address. The controller will prompt you to enter the address.

Press key k5 'Adrs UUA' to enter HP 4195A's HP-IB address. The controller will prompt you to enter the address.

NOTE

If you are using a model 226 (HP 9826) computer, only the leading eight characters of the key labels are displayed, for example, 'Next Sig' is displayed instead of 'Next Sig Gen'.

ADJUSTMENTS

7. Press key k8 'NextStep'.
8. Press key k1 'Serial Number', enter the serial number, and press the ENTER key to change the serial number of the Power Sensor.
9. Enter the values to change the calibration factors of the Sensor as follows.
 - a. Press key k2 'Cal Factor'.
 - b. Enter the Sensor calibration factor for 0.1 MHz, and press the ENTER key.
 - c. Enter the Sensor calibration factors for 1 MHz to 1000 MHz using the same manner as in step b.
10. Press key k3 'ATT Value', enter the step attenuator's calibrated attenuation of 30 dB (at 50 MHz), and press the ENTER key.
11. Press key k8 'NextStep' to display the receiver Adjustment Menu.

NOTE

This program has two adjustment menus, **Receiver Adjustment Menu** and **Signal Source Adjustment Menu**. If you press key k6 'Menu 2/2' on the Receiver Adjustment Menu, the Signal Source Adjustment Menu will be displayed, and when you press key k6 'Menu 1/2' on the Signal Source Adjustment Menu, the Receiver Adjustment Menu will be displayed.

Perform the Receiver Adjustments first.

If an error occurs or valid measurement results cannot be obtained, an error message will be displayed and the program will halt. Read the error message and press key k6 'Abort' to return to the menu. After correcting the condition which caused the error, retry the adjustment. If an error occurs and key k6 'Abort' is not displayed, refer to your computer's Operation Manual for help.

If you selected the wrong adjustment/calibration procedure or started with the wrong setup, press key k6 'Abort' to abort the measurement or calibration, and return to the menu.

3-25-2. RECEIVER BPF TUNING VOLTAGE CALIBRATION DATA UPDATING

This adjustment builds tuning voltage versus tuned frequency relationship table, and stores the table into EEPROM.

EQUIPMENT:

Signal Generator	HP 8656B
N(m)-N(m) Cable, 61 cm	HP 11500B
BNC(m)-BNC(m) Cable, 50 Ω , 122 cm	PN 8120-1840

PROCEDURE:

1. On the Receiver Adjustment Menu, press controller key k1 'BPF Tune Voltage'.

ADJUSTMENTS

2. Connect **INPUT R1** to the Signal Generator **RF OUTPUT** using the N(m)-N(m) cable, as shown in Figure 3-140.
3. Connect the Control Unit rear panel **EXT REFERENCE** to the Signal Generator **TIME BASE OUTPUT** using a BNC(m)-BNC(m) cable, as shown in Figure 3-140.

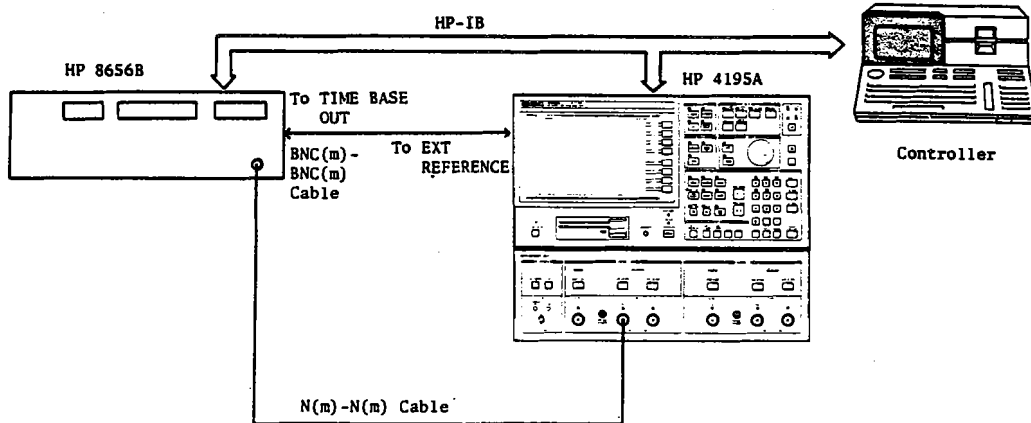

Figure 3-140. Receiver BPF Tuning Voltage Calibration Setup

4. Press key k8 'READY'.
5. Wait until the controller beeps and displays the message "Test Completed".

NOTE

The run time for this automatic adjustment is approximately 20 minutes. The Receiver Adjustment Menu will be displayed at the completion of this calibration.

3-25-3. FIRST IF CONVERTER OUTPUT LEVEL FINE ADJUSTMENT

This procedure finely adjusts the 86.6 MHz and 246 MHz output levels of the First IF Converter which were coarse adjusted in paragraph 3-16.

EQUIPMENT:

Signal Generator	HP 8656B
N(m)-N(m) Cable, 61 cm	HP 11500B
BNC(m)-BNC(m) Cable, 122 cm	PN 8120-1840

PROCEDURE:

1. Press controller key k2 'IF Level Adjust' on the Receiver Adjustment Menu.
2. Position the HP 4195A as shown in Figure 3-141.

ADJUSTMENTS

3. Connect an N(m)-N(m) cable from **INPUT R1** to the Signal Generator **RF OUTPUT** as shown in Figure 3-141.
4. Connect a BNC(m)-BNC(m) cable from the Control Unit rear panel **EXT REFERENCE INPUT** to the Signal Generator **TIME BASE OUTPUT**, as shown in Figure 3-141.

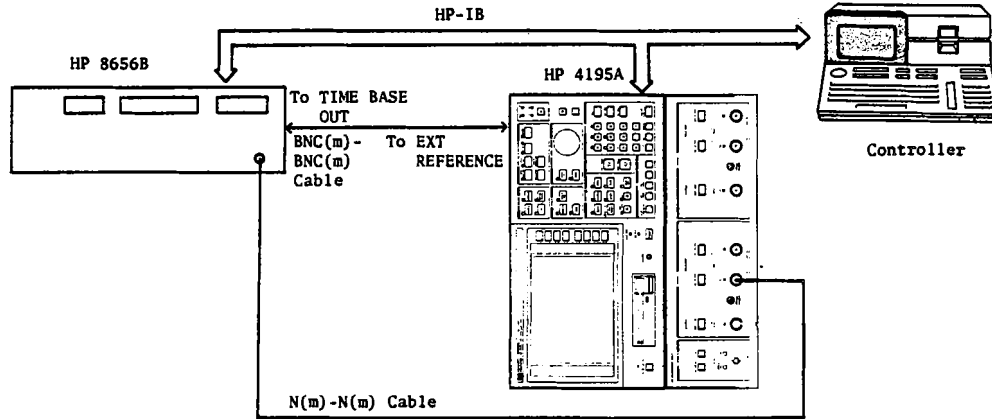

Figure 3-141. First IF Converter Level Fine Adjustments Setup

5. Press key k8 'READY'. "Turn on DIP switch A8SW1-5." will be displayed.
6. Turn the HP 4195A off.
7. Set bit 5 of DIP switch **A8SW1** to the **ON** position, as shown in Figure 3-142.

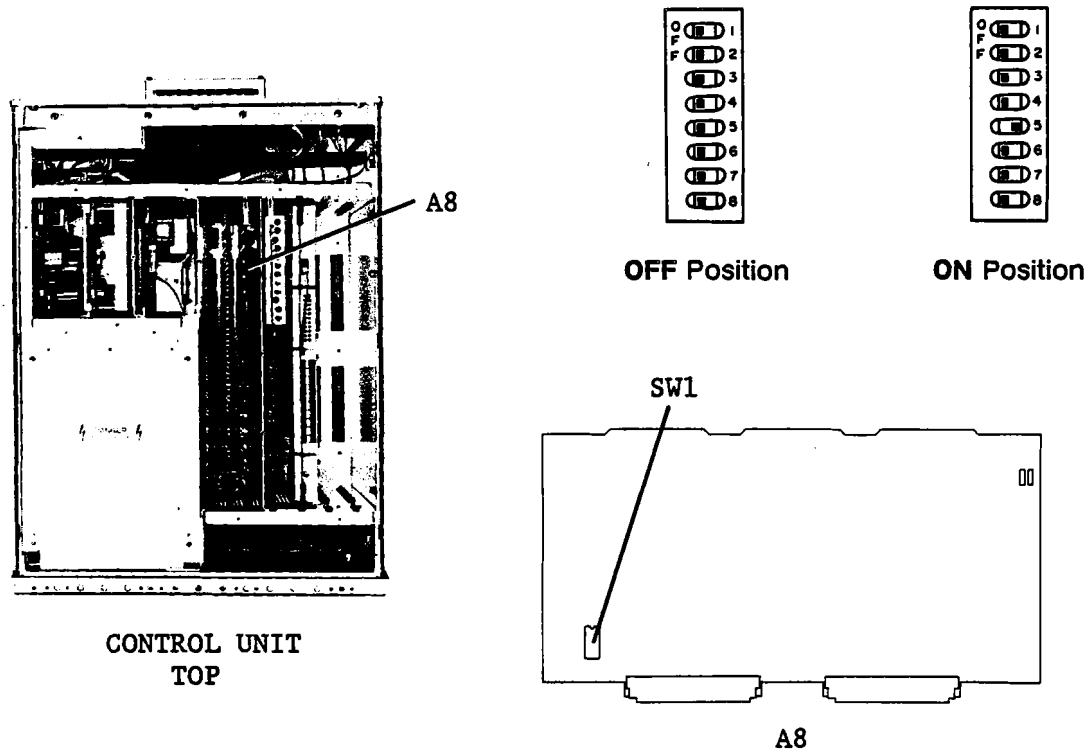

Figure 3-142. A8SW1 DIP Switch Location

ADJUSTMENTS

- Turn the HP 4195A on.
- Wait until the HP 4195A starts the sweep measurement, then press key k8 'READY'.
- Wait until the controller beeps.

NOTE

The run time for this automatic adjustment is approximately 3 minutes. "Adjust A22R52. MARKER reading -27 dBm \pm 0.1 dB" will be displayed. The o marker will point to the maximum trace value in the frequency range below 150 MHz.

- Adjust A22R52 (246MHz LEVEL ADJ) until the o marker value reads -27 dBm \pm 0.1 dB.

NOTE

If you are unable to adjust the level as specified, slightly rotate A21R9, then adjust A22R52. See Figure 3-84 for the location of A21R9.

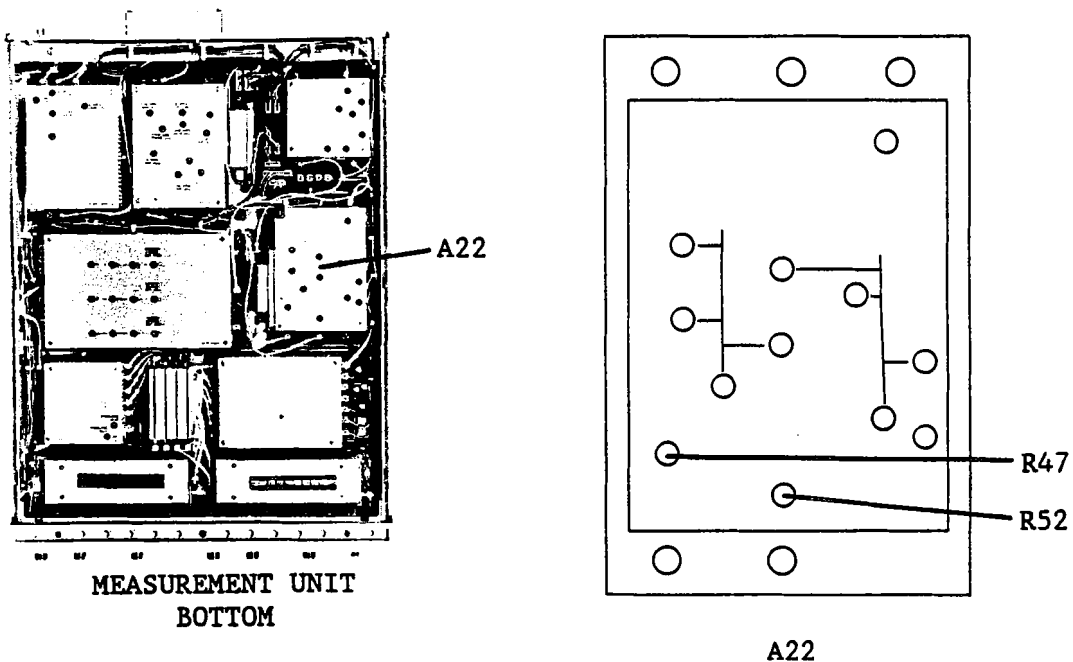

Figure 3-143. First IF Converter Level Fine Adjustment Locations

- Press key k8 'End Adj.' to finish 246 MHz level adjustment and proceed to the next adjustment.

The controller will beep and display the message "Adjust A22R47. MARKER reading -27 dBm \pm 0.1 dB". The o marker will point to the maximum trace value in the frequency range above 150 MHz.

- Adjust A22R47 (86.6 MHz LEVEL ADJ) until the o marker value reads -27 dBm \pm 0.1 dB.

ADJUSTMENTS

14. Press key k8 'End Adj.' key.

"Turn off DIP switch A8SW1-5." will be displayed.

15. Turn the HP 4195A off.

16. Set Bit 5 on DIP switch A8SW1 to the off position, as shown in Figure 3-142.

17. Turn the HP 4195A on.

18. Wait until the HP 4195A starts the sweep measurement, then press key k8 'READY'.

3-25-4. RECEIVER FREQUENCY RESPONSE CALIBRATION DATA UPDATING

This adjustment measures the receiver's raw frequency response, and stores compensation data for the raw frequency characteristics into an EEPROM.

EQUIPMENT:

Signal Generator	HP 8656B	
Power Meter	HP 436A Opt. 022	
Power Sensor	HP 8482A	
Power Splitter	HP 11667A	
Attenuator	HP 8496A/G Opt. 001	
N(m)-N(m) Cable, 61 cm	HP 11500B	
N(m)-N(m) Adapter, 50 Ω	PN 1250-1475	2 ea.
BNC(m)-BNC(m) Cable, 50 Ω , 122 cm	PN 8120-1840	

PROCEDURE:

1. Press controller key k3 'Freq Response' on the Receiver Adjustment Menu.
2. Position the HP 4195A on its right side as shown in Figure 3-144.
3. Connect the HP 4195A, Signal Generator, Power Meter, Power Sensor, Power Splitter, and Attenuator as shown in Figure 3-144.

4. Connect a BNC(m)-BNC(m) cable from the Control Unit rear panel **EXT REFERENCE** to the Signal Generator **TIME BASE OUTPUT**.

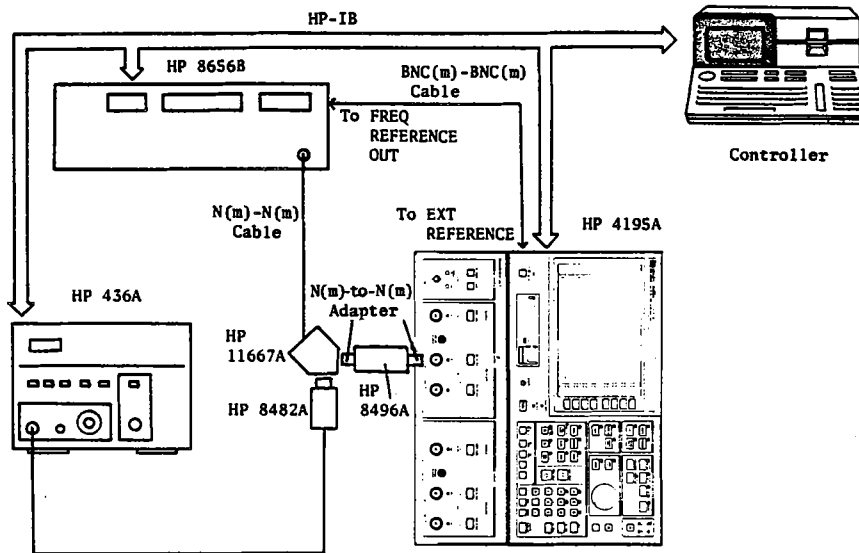

Figure 3-144. Receiver Frequency Response Calibration Setup

NOTE

Use N(m)-N(m) adapters (not cables) to keep the signal path as short as possible when connecting the Power Splitter OUTPUT to HP 4195A INPUT R1.

5. Set the step attenuator to 30 dB. Then press key k8 'READY'.
6. Wait until the controller beeps and displays the message, "Test Completed".

NOTE

The run time for this automatic adjustment is approximately 2 minutes.

3-25-5. SOURCE BPF TUNING VOLTAGE CALIBRATION DATA UPDATING

This adjustment builds tuning voltage versus tuned frequency relationship table, and stores the table into an EEPROM.

EQUIPMENT:

N(m)-N(m) Cable, 61 cm

HP 11500B

PROCEDURE:

1. Press controller key k6 'Menu 2/2' to select the Signal Source Adjustment Menu, then press key k1 'BPF Tune Voltage' of the Signal Source Adjustment Menu.

ADJUSTMENTS

2. Connect a N(m)-N(m) cable from **OUTPUT S1** to **INPUT R1**, as shown in Figure 3-145.

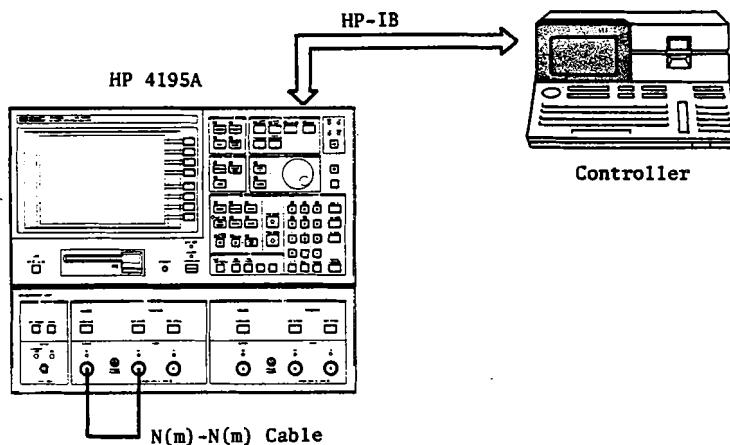

Figure 3-145. Source BPF Tuning Voltage Calibration Setup

3. Press key k8 'READY' to start the calibration.
4. Wait until the controller beeps and displays the message, "Test Completed".

NOTE

The run time for this procedure is approximately 10 minutes. The Signal Source Adjustment menu will be displayed at the completion of this adjustment.

3-25-6. SIGNAL SOURCE GAIN ADJUSTMENT

This adjustment adjusts the OSC level vernier circuit's gain (D-A converter output DC voltage versus output AC signal level).

EQUIPMENT:

Power Meter
Power Sensor

HP 436A Opt.022
HP 8482A

PROCEDURE:

1. Press controller key k2 'Gain Adjustment' on the Signal Source Adjustment Menu.
2. Connect an N(m)-N(m) cable from **OUTPUT S1** to **INPUT R1** as shown in Figure 3-146.

ADJUSTMENTS

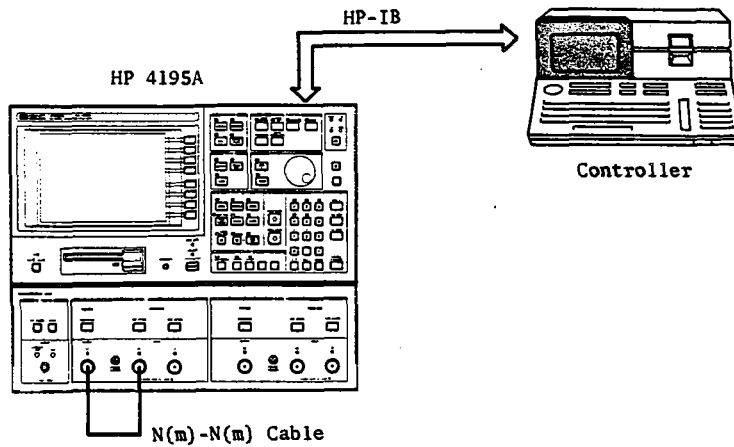

Figure 3-146. Signal Source Gain Adjustment Setup (1)

3. Press key k8 'READY', and wait until the controller beeps.
4. Connect the Sensor to INPUT S1 as shown in Figure 3-146, then press key k8 'READY'.

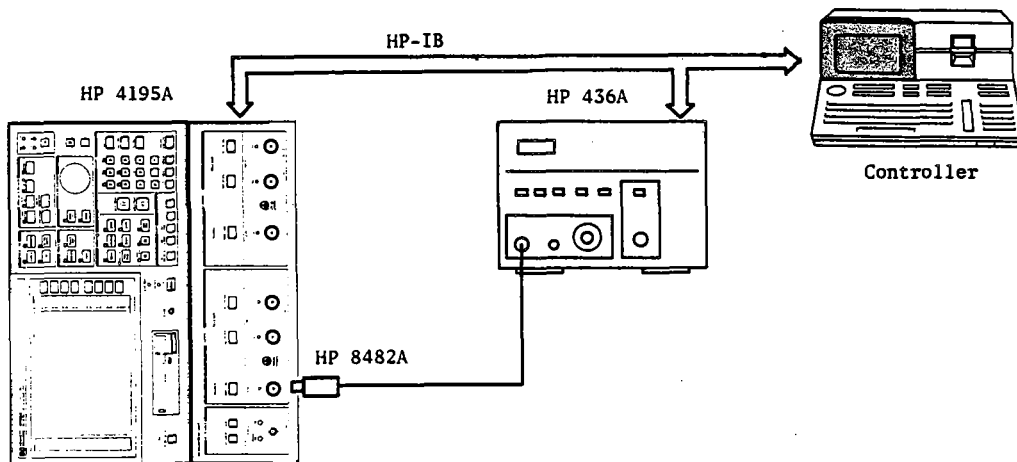

Figure 3-146. Signal Source Gain Adjustment Setup (2)

5. Set the Meter CAL FACTOR % dial as instructed by the controller display, then press key k8 'READY'.

NOTE

If the HP 438A is used, step 5 will be skipped, because this function is automatically performed.

6. Adjust A130R53 (6.6 MHz LEVEL ADJ) until the Meter reads 9.0 dBm \pm 0.1 dB.

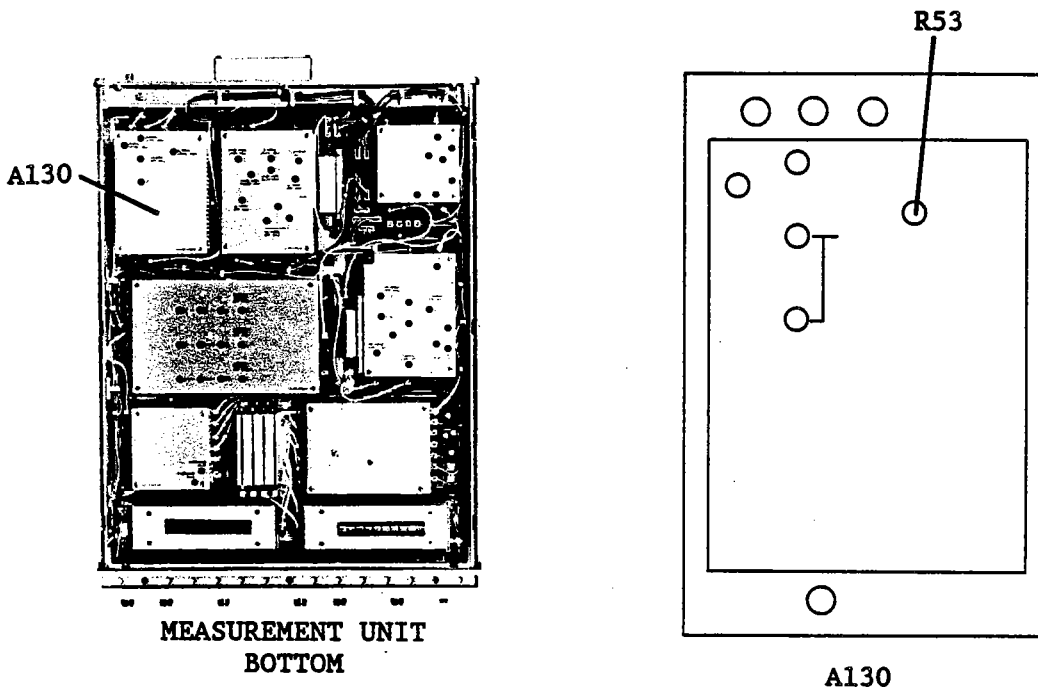

Figure 3-148. Signal Source Gain Adjustment Locations

7. Press key k8 'End Adj.'.

3-25-7. SIGNAL SOURCE AMPLITUDE CALIBRATION DATA UPDATING

This adjustment measures the signal source's raw output amplitude, and stores compensation data for the raw characteristics into an EEPROM.

EQUIPMENT:

Power Meter
Power Sensor

HP 436A Opt.022
HP 8482A

PROCEDURE:

1. Press controller key k3 'Amplitude' on the Signal Source Adjustment Menu.
2. Connect the Sensor to **OUTPUT S1**, as shown in Figure 3-149.

ADJUSTMENTS

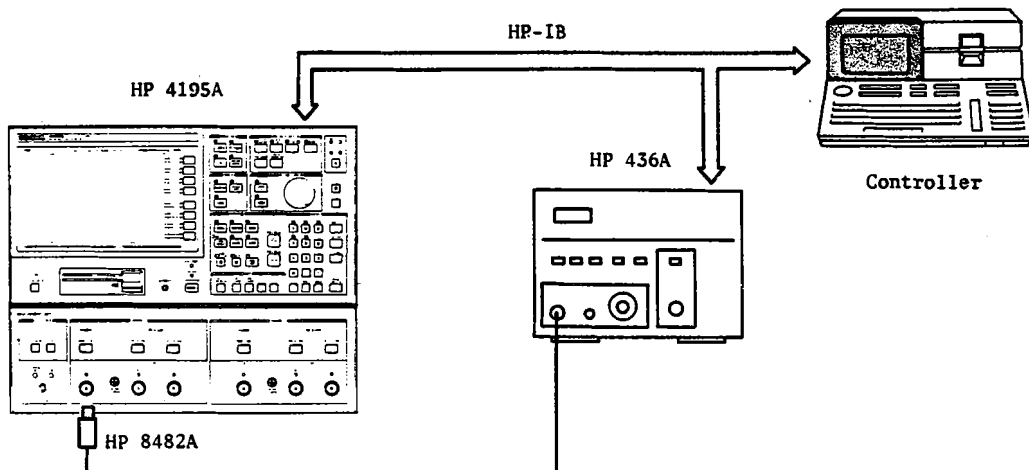

Figure 3-149. Signal Source Amplitude Calibration Setup

3. Press key k8 'READY'.
4. Wait until the controller beeps and displays the message, "Test Completed".

3-25-8. SIGNAL SOURCE LINEARITY CALIBRATION DATA UPDATING

This adjustment measures the signal source's raw output linearity, and stores compensation data for the raw characteristics into an EEPROM.

EQUIPMENT:

N(m)-N(m) Cable, 61 cm

HP 11500B

PROCEDURE:

1. Press the controller key k4 'Linearity' on the Signal Source Adjustment Menu.
2. Connect an N(m)-N(m) cable from **OUTPUT S1** to **INPUT R1**, as shown in Figure 3-150.

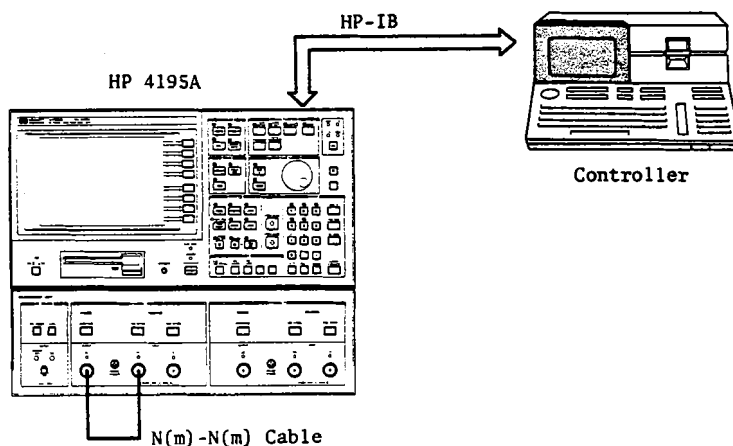

Figure 3-150. Signal Source Linearity Calibration Setup

ADJUSTMENTS

3. Press key k8 'READY'.
4. Wait until the controller beeps and displays the message, "Test Completed".

NOTE

The run time for this automatic adjustment is approximately 1 minute. The Signal Source Adjustment Menu will be displayed at the completion of this calibration.

3-25-9. SIGNAL SOURCE FLATNESS CALIBRATION DATA UPDATING

This adjustment measures the signal source's raw output flatness (frequency response), and stores compensation data for the raw characteristics into an EEPROM.

EQUIPMENT:

N(m)-N(m) Cable, 61 cm

HP 11500B

PROCEDURE:

1. Press the key k5 'Flatness' on the Signal Source Adjustment Menu.
2. Connect an N(m)-N(m) cable from **OUTPUT S1** to **INPUT R1** connector, as in the Signal Source Linearity Calibration as shown in Figure 3-150.
3. Press key k8 'READY'.
4. Wait until the controller beeps and displays the message, "Test Completed".

3-25-10. EXITING THE ADJUSTMENT PROGRAM

After completing all adjustments exit the Adjustment Program as follows.

PROCEDURE:

1. Confirm that the controller is displaying the Signal Source Adjustment Menu or the Receiver Adjustment Menu.
2. Press controller key k8 'Exit'.

"Change jumper A8W2 to its uppermost position." will be displayed.
3. Turn the HP 4195A off.
4. Relocate jumper **A8W2** jumper to its uppermost position to write protect the EEPROM, as shown in Figure 3-139.
5. Press the key k8 'READY' key.

ADJUSTMENTS

NOTE

The controller will beep and display the message, "HP 4195A Adjustment Program Completed" when the Adjustment Program is completed.

APPENDIX A

MANUAL BACKDATING

This appendix contains the information required to adapt this manual to earlier versions or configurations of the HP 4195A than the current printing date of this manual. The information in this manual applies directly to HP 4195A Network/Spectrum Analyzers whose serial number prefix is listed on the title page of this manual.

To adapt this manual to your HP 4195A, refer to Table A and B, and make all of the manual changes listed opposite your instrument's serial number and ROM based firmware's revision.

Instruments manufactured after the printing of this manual may be different than those documented in this manual. Later instrument versions will be documented in a manual changes supplement that will accompany the manual shipped with that instrument. If your instrument serial number is not listed on the title page of this manual or in Table A, it may be documented in the yellow **MANUAL CHANGES** supplement. Refer to the description of the **REV?** command in paragraph 6-5-3 of the HP 4195A **Operation Manual** for confirmation of the ROM based firmware's revision. For additional information on serial number coverage, refer to **SERIAL NUMBER** in **SECTION 7** of the **Operation Manual**.

Table A. Manual Changes by Serial Number

Serial Prefix or Number	Make Manual Changes
2830J- and below	1

Table B. Manual Changes by Firmware's Revision

Revision	Make Manual Changes
1.02 and below	2

CHANGE 1:

Perform the **3-11-1. 80 MHz REFERENCE SOURCE LEVEL ADJUSTMENT** using the procedure on page A-3 through A-4.

CHANGE 2:

Perform the **3-21. SOURCE OUTPUT FILTER ADJUSTMENT** using the procedure on page A-5 through A-15

3-11-1. 80 MHz REFERENCE SOURCE LEVEL ADJUSTMENT (for A10 PN 04195-65010)**NOTE**

If the unit has a label "HIGH PURITY LOCAL OSC INSTALLED" on the Control Unit rear panel, perform adjustment described in the paragraph 3-11-1.

This procedure adjusts the output level of the 80 MHz reference source.

EQUIPMENT:

Spectrum Analyzer
BNC(m)-BNC(m) Cable, 50Ω, 122 cm
N(m)-BNC(f) Adapter
Extender Board

HP 8568B
PN 8120-1840
PN 1250-0780
PN 04195-66590

SUMMARY:

MONITOR: J3 (80 MHz OUT) on Control Unit rear panel

ADJUSTMENT COMPONENT: A10C1 (REF LEVEL ADJ)

TARGET: Output Level: -10.4 dBm \pm 0.5 dBm
(with an extender board and a 122 cm test cable)

PROCEDURE:

1. Extend the A10 board.
2. Connect the equipment as shown in Figure A-1.

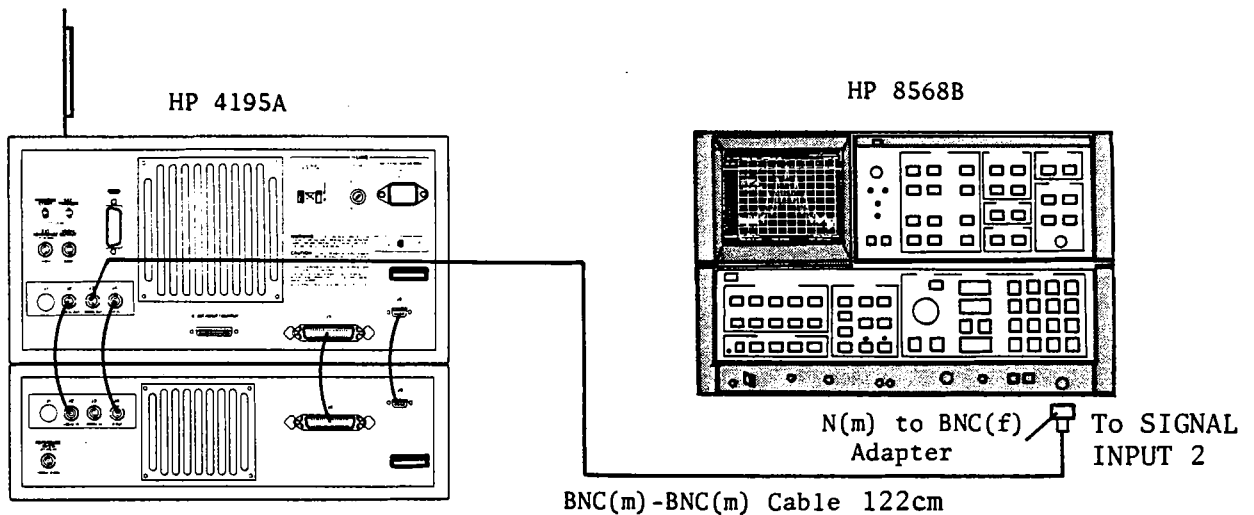

Figure A-1. 80 MHz Reference Source Level Adjustment Setup

3. Set up the Spectrum Analyzer as follows.

CENTER FREQUENCY	80 MHz
SPAN	1 MHz

4. Turn the HP 4195A on.

5. Adjust A10C1 (REF LEVEL ADJ) until the 80 MHz signal level is -10.4 dBm \pm 0.5 dB.

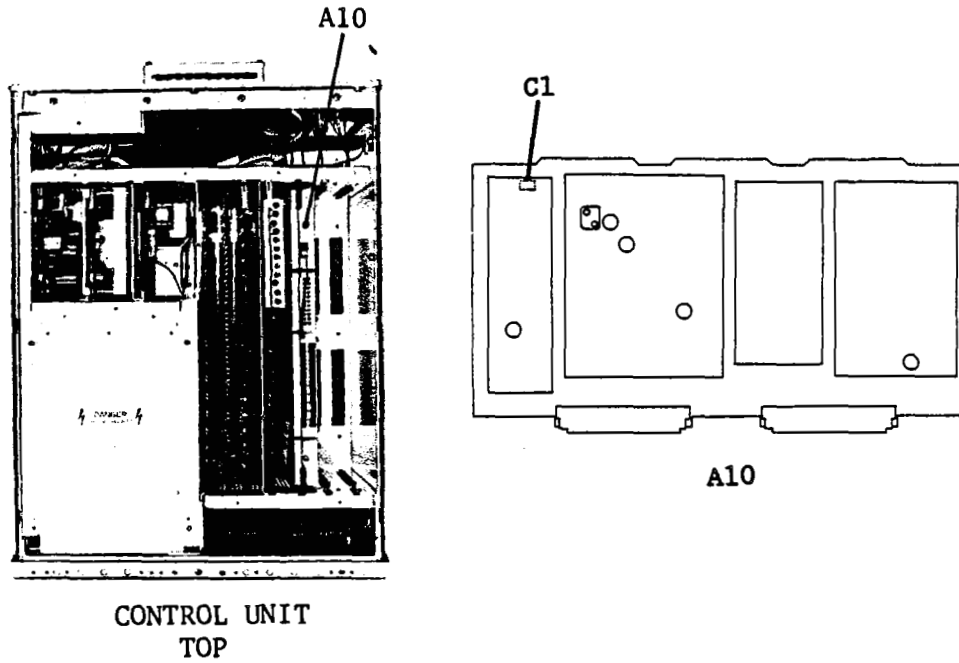

Figure A-2. 80 MHz Reference Source Level Adjustment Locations

3-21. SOURCE OUTPUT FILTER ADJUSTMENTS

The procedure adjusts the three Voltage Tuned Band Pass Filters of the source output filter.

EQUIPMENT:

Network Analyzer	HP 8753A	
Digital Voltmeter	HP 3456A	
Power Splitter	HP 11667A	
N(m)-N(m) Cable, 61cm	HP 11500B	2 ea.
Alligator Clips to Dual Banana Cable	HP 11002A	
BNC(m)-BNC(m) Cable, 122 cm	PN 8120-1840	
BNC(m)-SMB(f) Cable, 122 cm	PN 85680-60093	2 ea.
N(m)-BNC(f) Adapter	PN 1250-1476	2 ea.
SMB(m)-SMB(m) Adapter	PN 1250-0813	
Interconnect Cable, 9 pin	PN 16349-61601	
Interconnect Cable, 50 pin	PN 16349-61602	
Interconnect Cable, BNC(m)	PN 16349-61603	3 ea.

3-21-1. 150 - 225 MHz VOLTAGE TUNED BPF ADJUSTMENT**SUMMARY:**

MONITOR:		A44J2
ADJUSTMENT COMPONENT:	A44L1, L2, L3, L4 (150-225 MHz BPF ADJ)	
TARGET:	Gain at the maximum point:	≥12 dB
	-0.3 dB Band Width:	≥1 MHz

PROCEDURE:

1. Position the HP 4195A as shown in Figure A-3.
2. Connect the Power Splitter to the Network Analyzer as shown in Figure A-3.
3. Connect the N(m)-BNC(f) Adapter and BNC(m)-SMB(f) Cable to one of the Power Splitter **OUTPUTS**.
4. Connect the N(m)-BNC(f) Adapter and BNC(m)-SMB(f) Cable to the Network Analyzer **INPUT**.
5. Connect the Alligator Clips to Dual Banana Cable to the Voltmeter **INPUT**.

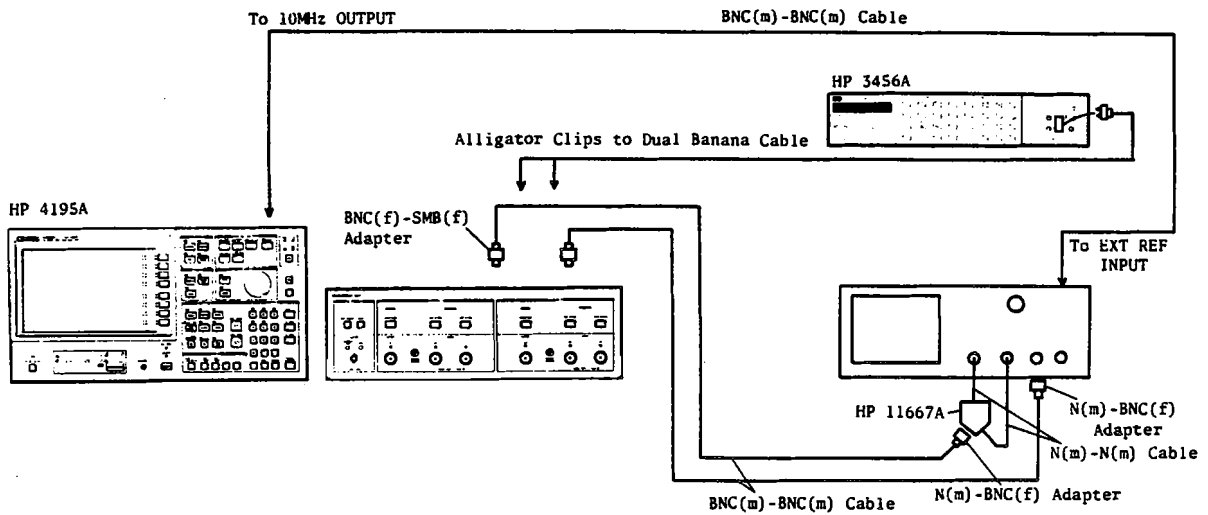

Figure A-3. Source Output Filter Adjustment Setup

6. Connect the Voltmeter **LOW** lead input to ground, and **HIGH** lead to the center pin of HP 4195A A44C1 as shown in Figure A-4.

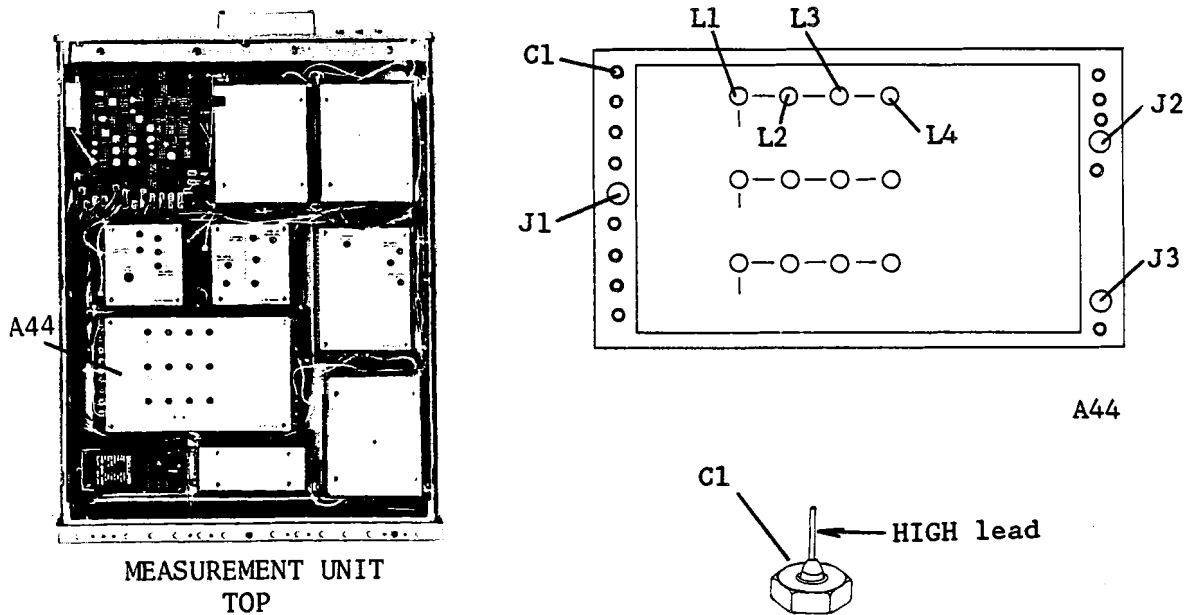

Figure A-4. 150 - 225 MHz Voltage Tune BPF Adjustment Locations

7. Turn the HP 4195A on, and enter the "STSET" command using the following key strokes to display the Service Function menu.

Blue shiftkey, S, T, S, E, T, ENTER/EXECUTE key

8. Enter the "STN=51" command to enter to the Service Function No. 51 mode, using the following key strokes.

'TEST No.' softkey, 5, 1, ENTER/EXECUTE key

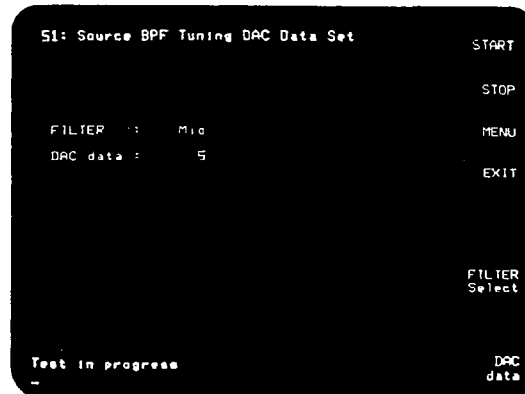

Figure A-5. Service Function No. 51 Display

9. Press the HP 4195A 'START' softkey, and set the FILTER on the HP 4195A display to **LOW**.
10. Set the DAC data value displayed on the HP 4195A display to 3, using the following key strokes.

'DAC data' softkey, 3, ENTER/EXECUTE key

11. Make a note of the Voltmeter reading.
12. Press the 'EXIT' softkey, and set up the HP 4195A as follows.

COMMAND

CONFIGURATION	NETWORK	FNC1
INITIALIZE	PRESET	RST
START FREQUENCY	150 MHz	START= 150 MHz
STOP FREQUENCY	224.999 999 999 MHz	STOP= 224.999 999 999 MHz
SWEEP MODE	MANUAL	SWM3

13. Move the HP 4195A o marker (manual sweep marker) to the point at which the Voltmeter reading is equal to or greater than the reading noted in step 11.

NOTE

If the Voltmeter reading at the 150 MHz frequency point is greater than the reading noted in step 11, place the o marker to the 150 MHz point.

14. Make a note of the frequency at the HP 4195A o marker position.
15. Turn the HP 4195A off, and disconnect the Voltmeter input Cable from the HP 4195A.
16. Disconnect coaxial cable (I) from A44J1.
17. Disconnect coaxial cable (C) from A44J2 and A44J3.

18. Set up the Network Analyzer as follows.

Center Frequency:	150 MHz
Span Frequency:	10 MHz

19. Connect the SMB(m)-SMB(m) Adapter between the Power Splitter **OUTPUT** cable and the Network Analyzer **INPUT** cable.

20. Perform a Network Analyzer **THROUGH** calibration.

21. Disconnect the SMB(m)-SMB(m) Adapter from the Power Splitter **OUTPUT** cable and the Network Analyzer **INPUT** cable.

22. Connect the Power Splitter **OUTPUT** cable to A44J1.

23. Connect the Network Analyzer **INPUT** cable to A44J2.

24. Turn the HP 4195A on, and set it to the same settings used in step 12.

25. Place HP 4195A o marker to the same position as in step 14.

26. Adjust A44L1, L2, L3, and L4 until the following conditions are satisfied.

- | | |
|--|--------------------|
| 1. -0.3 dB Pass Band Center Frequency: | 150 MHz to 151 MHz |
| 2. Gain at maximum point: | ≥ 12 dB |
| 3. -0.3 dB Band Pass Filter: | ≥ 1 MHz |

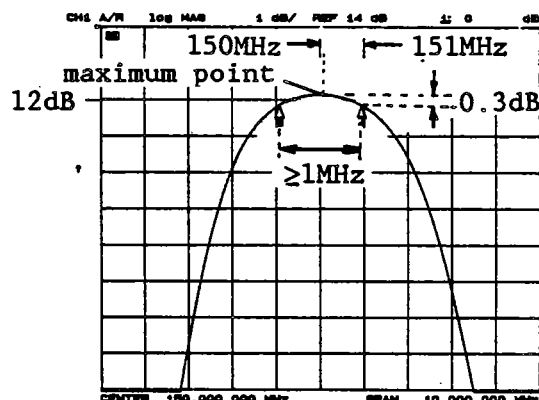

Figure A-6. 150 - 225 MHz Voltage Tune BPF Adjustment Example

27. Turn the HP 4195A off, and disconnect the Power Splitter **OUTPUT** cable and Network Analyzer **INPUT** cable.

28. Change the Network Analyzer Center Frequency to 180 MHz.

29. Repeat steps 19 through 24.

30. Place the HP 4195A o marker to the 180 MHz frequency point.

31. Adjust A44L1, L2, L3, and L4 until the following conditions are satisfied.

- | | |
|------------------------------|--------------|
| 1. Gain at maximum point: | ≥ 12 dB |
| 2. -0.3 dB Band Pass Filter: | ≥ 1 MHz |

-
32. Turn the HP 4195A off, and disconnect the Power Splitter **OUTPUT** cable and Network Analyzer **INPUT** cable.
 33. Change the Network Analyzer Center Frequency to 225 MHz.
 34. Repeat steps 19 through 24.
 35. Place the HP 4195A o marker on the STOP FREQUENCY point.
 36. Adjust A44L1, L2, L3, and L4 until the following conditions are satisfied.
 1. Gain at maximum point: ≥12 dB
 2. -0.3 dB Band Pass Filter: ≥1 MHz
 37. Turn the HP 4195A off, and disconnect the Power Splitter **OUTPUT** cable and the Network Analyzer **INPUT** cable from A44J1 and A44J2.
 38. Repeat steps 18 through 37, until all conditions of steps 26, 31 and 36 are satisfied without further adjustment.

3-21-2. 225 - 340 MHz VOLTAGE TUNED BPF ADJUSTMENT**SUMMARY:**

MONITOR:		A44J2
ADJUSTMENT COMPONENT:	A44L15, L16, L17, L18 (225 - 340 MHz BPF ADJ)	
TARGET:	Gain at the maximum point:	≥12 dB
	-0.3 dB Band Width:	≥1.5 MHz

PROCEDURE:

1. Position the HP 4195A as shown in Figure A-3, paragraph 3-21-1.
2. Connect the Power Splitter to the Network Analyzer as shown in Figure A-3, paragraph 3-21-1.
3. Connect the N(m)-BNC(f) Adapter and BNC(m)-SMB(f) Cable to one of the Power Splitter **OUTPUTS**.
4. Connect the N(m)-BNC(f) Adapter and BNC(m)-SMB(f) Cable to the Network Analyzer **INPUT**.
5. Connect the Alligator Clips to Dual Banana Cable to the Voltmeter **INPUT**.
6. Connect the Voltmeter input cable **LOW** lead to ground, and **HIGH** lead to the center pin of HP 4195A A44C59, as shown in Figure A-7.

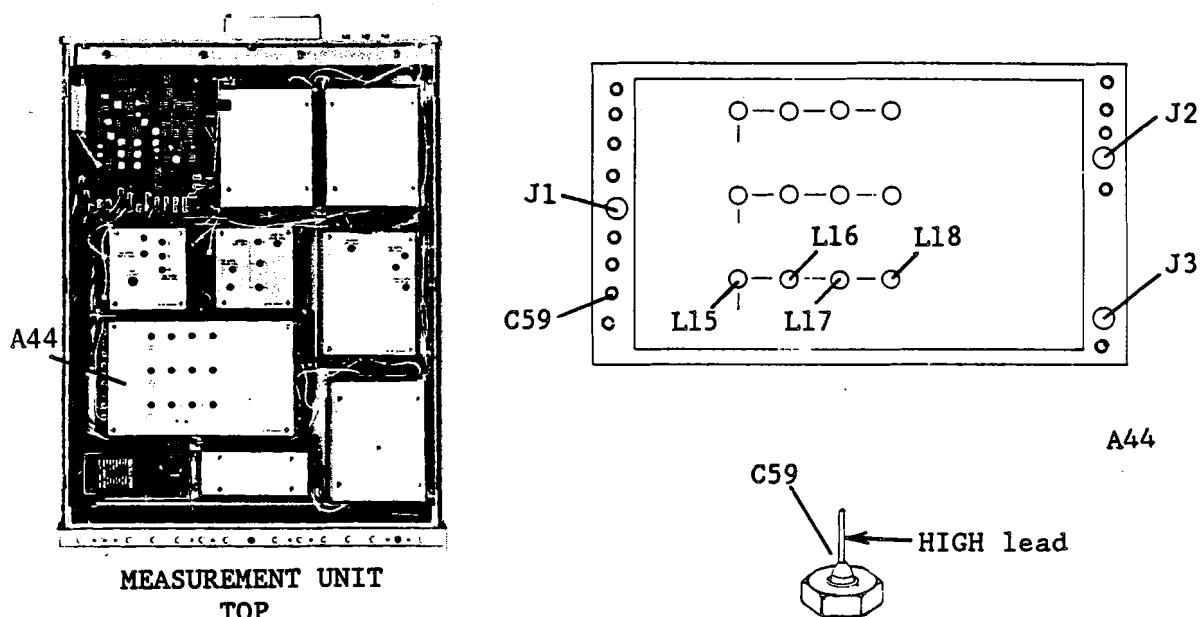

Figure A-7. 225 - 340 MHz Voltage Tune BPF Adjustment Locations

7. Turn the HP 4195A on, and enter the "STSET" command using the following key strokes to display the Service Function menu.

Blue shiftkey, S, T, S, E, T, ENTER/EXECUTE key

8. Enter the "STN=51" command using the following key strokes to enter to the Service Function No. 51 mode.

'TEST No.' softkey, 5, 1, ENTER/EXECUTE key

9. Press the HP 4195A 'START' softkey, and set the FILTER on the HP 4195A display to MID.

10. Set the DAC data value displayed on the HP 4195A display to 3 using the following key strokes.

'DAC data' softkey, 3, ENTER/EXECUTE key

11. Make a note of the Voltmeter reading.

12. Press the HP 4195A 'EXIT' softkey, and set up the HP 4195A as follows.

COMMAND

CONFIGURATION	NETWORK	FNC1
INITIALIZE	PRESET	RST
START FREQUENCY	225 MHz	START= 225 MHZ
STOP FREQUENCY	339.999 999 999 MHz	STOP= 339.999 999 999 MHZ
SWEEP MODE	MANUAL	SWM3

13. Move the HP 4195A o marker (manual sweep marker) to the point at which the Voltmeter reading is equal to or greater than the reading noted in step 11.

NOTE

If the Voltmeter reading at the 225 MHz frequency point is greater than the reading noted in step 11, place the o marker to the 225 MHz point.

14. Make a note of the frequency at the HP 4195A o marker position.
15. Turn the HP 4195A off, and disconnect the Voltmeter Input Cable from the HP 4195A.
16. Disconnect coaxial cable (I) from A44J1.
17. Disconnect coaxial cables (C) from A44J2 and A44J3.
18. Set up the Network Analyzer as follows.

Center Frequency:	225 MHz
Span Frequency:	10 MHz

19. Connect the SMB(m)-SMB(m) Adapter between the Power Splitter **OUTPUT** cable and the Network Analyzer **INPUT** cable.
20. Perform a Network Analyzer **THROUGH** calibration.
21. Disconnect the SMB(m)-SMB(m) Adapter from the Power Splitter **OUTPUT** cable and the Network Analyzer **INPUT** cable.
22. Connect the Power Splitter **OUTPUT** cable to A44J1.
23. Connect the Network Analyzer **INPUT** cable to A44J2.
24. Turn the HP 4195A on, and set it to the same settings used in step 12.
25. Place the HP 4195A o marker to the o marker position noted in step 14.
26. Adjust A44L15, L16, L17, and L18 until the following conditions are satisfied.
- | | |
|--|--------------------|
| 1. -0.3 dB Pass Band Center Frequency: | 225 MHz to 226 MHz |
| 2. Gain at maximum point: | ≥12 dB |
| 3. -0.3 dB Band Pass Filter: | ≥1.5 MHz |

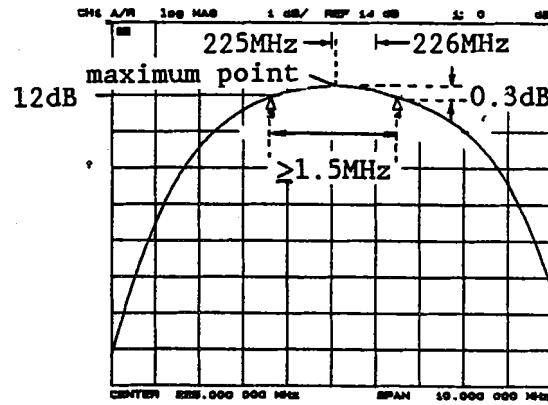

Figure A-8. 225 - 340 MHz Voltage Tune BPF Adjustment Example

27. Turn the HP 4195A off, and disconnect the Power Splitter **OUTPUT** cable and Network Analyzer **INPUT** cable.
28. Change the Network Analyzer Center Frequency to 285 MHz.
29. Repeat steps 19 through 24.
30. Place the HP 4195A o marker to the 285 MHz frequency point.
31. Adjust A44L15, L16, L17, and L18 until the following conditions are satisfied.
 1. Gain at maximum point: ≥ 12 dB
 2. -0.3 dB Band Pass Filter: ≥ 1.5 MHz
32. Turn the HP 4195A off, and disconnect the Power Splitter **OUTPUT** cable and the Network Analyzer **INPUT** cable.
33. Change the Network Analyzer Center Frequency to 340 MHz.
34. Repeat steps 19 through 24.
35. Place the HP 4195A o marker to the HP 4195A STOP FREQUENCY point.
36. Adjust A44L15, L16, L17, and L18 until the following conditions are satisfied.
 1. Gain at maximum point: ≥ 12 dB
 2. -0.3 dB Band Pass Filter: ≥ 1.5 MHz
37. Turn the HP 4195A off, and disconnect the Power Splitter **OUTPUT** cable and the Network Analyzer **INPUT** cable from A44J1 and A44J2.
38. Repeat steps 18 through 37, until all of the conditions in steps 26, 31 and 36 are satisfied without further adjustment.

3-21-3. 340 - 500 MHz VOLTAGE TUNED BPF ADJUSTMENT

SUMMARY:

MONITOR:

ADJUSTMENT COMPONENT: A44L6, L7, L8, L9 (340 - 500 MHz BPF ADJ)

TARGET: Gain at the maximum point: ≥ 12 dB
 -0.3 dB Band Width: ≥ 2 MHz

PROCEDURE:

1. Position the HP 4195A as shown in Figure A-3, paragraph 3-21-1.
2. Connect the Power Splitter to the Network Analyzer as shown in Figure A-3, paragraph 3-21-1.
3. Connect the N(m)-BNC(f) Adapter and BNC(m)-SMB(f) Cable to one of the Power Splitter **OUTPUTS**.
4. Connect the N(m)-BNC(f) Adapter and BNC(m)-SMB(f) Cable to the Network Analyzer **INPUT**.
5. Connect the Alligator Clips to Dual Banana Cable to the Voltmeter **INPUT**.
6. Connect the Voltmeter input cable **LOW** lead to ground and its **HIGH** lead to the center pin of HP 4195A A44C27, as shown in Figure A-9.

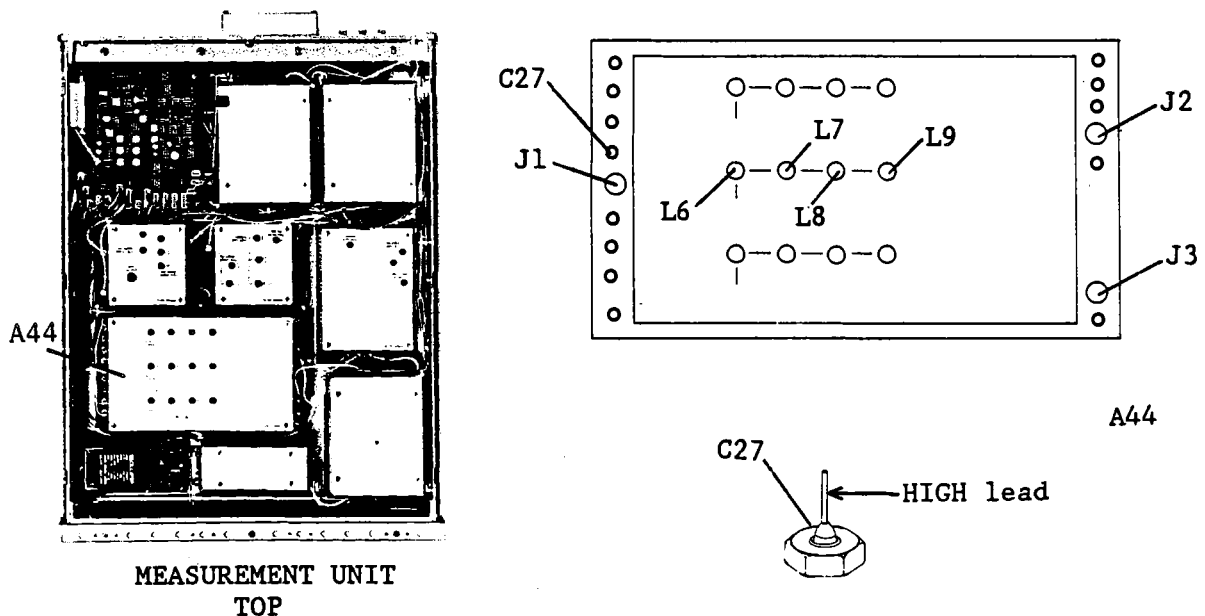

Figure A-9. 340 - 500 MHz Voltage Tuned BPF Adjustment Locations

7. Turn the HP 4195A on, and enter the "STSET" command using the following key strokes to display the Service Function menu.

Blue shiftkey, **S, T, S, E, T, ENTER/EXECUTE** key

8. Enter the "*STN=51*" command using the following key strokes to enter to the Service Function No. 51 mode.

'TEST No.' softkey, **5, 1, ENTER/EXECUTE** key

9. Press the HP 4195A '**START**' softkey, and set the **FILTER** on the HP 4195A display to **HIGH**.
10. Set the **DAC data** value displayed by the HP 4195A to 3, using the following key sequence.

'DAC data' softkey, **3, ENTER/EXECUTE** key

11. Make a note of the Voltmeter reading.
12. Press the HP 4195A '**EXIT**' softkey, and set up the HP 4195A as follows.

COMMAND

CONFIGURATION	NETWORK	FNC1
INITIALIZE	PRESET	RST
START FREQUENCY	340 MHz	START= 340 MHZ
STOP FREQUENCY	500 MHz	STOP= 500 MHZ
SWEEP MODE	MANUAL	SWM3

13. Move the HP 4195A o marker (manual sweep marker) to the point at which the Digital Voltmeter reading is equal to or greater than the reading in step 11.

NOTE

If the Voltmeter reading at the 340 MHz frequency point is greater than the reading in step 11, place the o marker to the 340 MHz point.

14. Make a note of the frequency at the HP 4195A o marker position.
15. Turn the HP 4195A off, and disconnect the Voltmeter Input Cable from the HP 4195A.
16. Disconnect coaxial cable (I) from A44J1.
17. Disconnect coaxial cable (C) from A44J2 and A44J3.
18. Set up Network Analyzer as follows.

Center Frequency:	340 MHz
Span Frequency:	20 MHz

19. Connect the SMB(m)-SMB(m) Adapter between the Power Splitter **OUTPUT** cable and the Network Analyzer **INPUT** cable.
20. Perform a Network Analyzer **THROUGH** calibration.

21. Disconnect the SMB(m)-SMB(m) Adapter from the Power Splitter **OUTPUT** cable and the Network Analyzer **INPUT** cable.
22. Connect the Power Splitter **OUTPUT** cable to A44J1.
23. Connect the Network Analyzer **INPUT** cable to A44J2.
24. Turn the HP 4195A on, and set it to the same settings used in step 12.
25. Place the HP 4195A o marker to the o marker position noted in step 14.
26. Adjust A44L6, L7, L8, and L9 until the following conditions are satisfied.
 1. -0.3 dB Pass Band Center Frequency: 340 MHz to 341 MHz
 2. Gain at maximum point: ≥ 12 dB
 3. -0.3 dB Band Pass Filter: ≥ 2 MHz

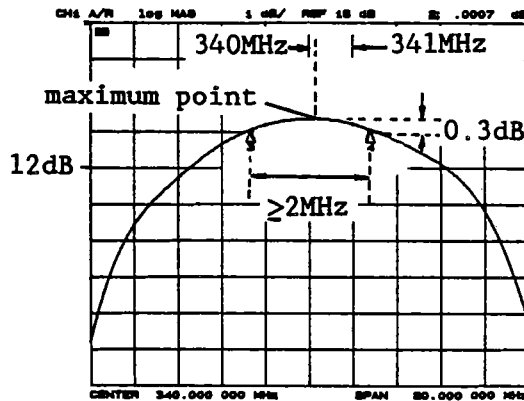

Figure A-10. 340 - 500 MHz Voltage Tuned BPF Adjustment Example

27. Turn the HP 4195A off, and disconnect the Power Splitter **OUTPUT** cable and Network Analyzer **INPUT** cable.
28. Change the Network Analyzer Center Frequency to 420 MHz.
29. Repeat steps 19 through 24.
30. Place the HP 4195A o marker to the 420 MHz frequency point.
31. Adjust A44L6, L7, L8, and L9 until the following conditions are satisfied.
 1. Gain at maximum point: ≥ 12 dB
 2. -0.3 dB Band Pass Filter: ≥ 2 MHz
32. Turn the HP 4195A off, and disconnect the Power Splitter **OUTPUT** cable and Network Analyzer **INPUT** cable.
33. Change the Network Analyzer Center Frequency to 500 MHz.
34. Repeat steps 19 through 24.
35. Place the HP 4195A o marker at the STOP FREQUENCY point.
36. Adjust A44L6, L7, L8, and L9 until the following conditions are satisfied.

- | | |
|------------------------------|--------------|
| 1. Gain at maximum point: | ≥ 12 dB |
| 2. -0.3 dB Band Pass Filter: | ≥ 2 MHz |
37. Turn the HP 4195A off, and disconnect the Power Splitter **OUTPUT** cable and the Network Analyzer **INPUT** cable from A44J1 and A44J2.
38. Repeat steps 18 through 37, until all of the conditions in steps 26, 31 and 36 are satisfied without further adjustment.

APPENDIX B

BOARD ASSEMBLY LIST

INCLUDED IN CONTROL UNIT (UPPER UNIT)

Assembly Number	Assembly Name
A1	Primary Rectifier Board Assembly
A2	Power Supply Control Board Assembly
A3	Power Supply Output Board Assembly
A4	CRT Deflection Amplifier Board Assembly (included in CRT Section)
A5	Video Amplifier Board Assembly (included in CRT Section)
A6	Signal Processor Board Assembly
A7	Graphic Display Controller/Shared RAM Board Assembly
A8	Measurement Control Processor Board Assembly
A9	Phase Detector/A-D Converter Board Assembly
A10	Frequency Generator Board Assembly
A10A1	Fractional N loop API Source Board Assembly
A10A2	Fractional N Loop API Switch Board Assembly
A10A3	Fractional N Loop Control Logic Board Assembly
A10A4	Fractional N Loop External Lock Board Assembly
A10A5	Fractional N Loop Phase Detector Board Assembly
A10A6	Fractional N Loop Sample/Hold Board Assembly
A12	Control Unit Keyboard Control Board Assembly
A13	Control Unit Keyboard Assembly
A14	Power Supply Motherboard Assembly
A15	Motherboard Assembly
A16	Flexible Disc Drive Controller Board Assembly
A17	CRT Socket Board Assembly (included in CRT Section)

INCLUDED IN MEASUREMENT UNIT (LOWER UNIT)

Assembly Number	Assembly Name
<p>Top Side</p> <p>A20 A21 A128 A22 A23 A24 A25 A25A1 A25A2 A25A3 A25A4 A26 A27 A28 A29 A30 A130</p>	<p>Receiver 3rd IF Converter Board Assembly Receiver 2nd IF Converter Board Assembly Receiver 1st IF Lowpass Filter Board Assembly Receiver 1st IF Converter Board Assembly Receiver Input Filter Board Assembly High Frequency Multiplexer Buffer Board Assembly High Frequency Multiplexer Assembly R1 Input High Frequency Switch Board Assembly T1 Input High Frequency Switch Board Assembly T2 Input High Frequency Switch Board Assembly R2 Input High Frequency Switch Board Assembly Low Frequency Multiplexer Board Assembly R2 Input Attenuator Board Assembly T2 Input Attenuator Board Assembly R1 Input Attenuator Board Assembly T1 Input Attenuator Board Assembly Reference Frequency Converter Board Assembly</p>
<p>Bottom Side</p> <p>A31 A32 A33 A34 A40 A43 A44 A45 A46 A47 A48 A50 A51 A52 A60</p>	<p>3rd IF Local Driver Amplifier Board Assembly 2nd IF Local Driver Amplifier Board Assembly 1st IF Local Driver Preamplifier Board Assembly 1st IF Local Driver Amplifier Board Assembly Source 2nd/3rd IF Converter Board Assembly Source 1st IF Converter Board Assembly Source Output Filter Board Assembly S2 Power Amplifier Board Assembly S1 Power Amplifier Board Assembly S2 Output Attenuator Board Assembly S1 Output Attenuator Board Assembly Receiver Circuit Control Board Assembly Source Circuit Control Board Assembly Measurement Unit Keyboard Assembly High Stability Oscillator Board Assembly (Option 001 only)</p>

APPENDIX C

BOARD ASSEMBLY LOCATIONS

CONTROL UNIT (UPPER UNIT) TOP VIEW

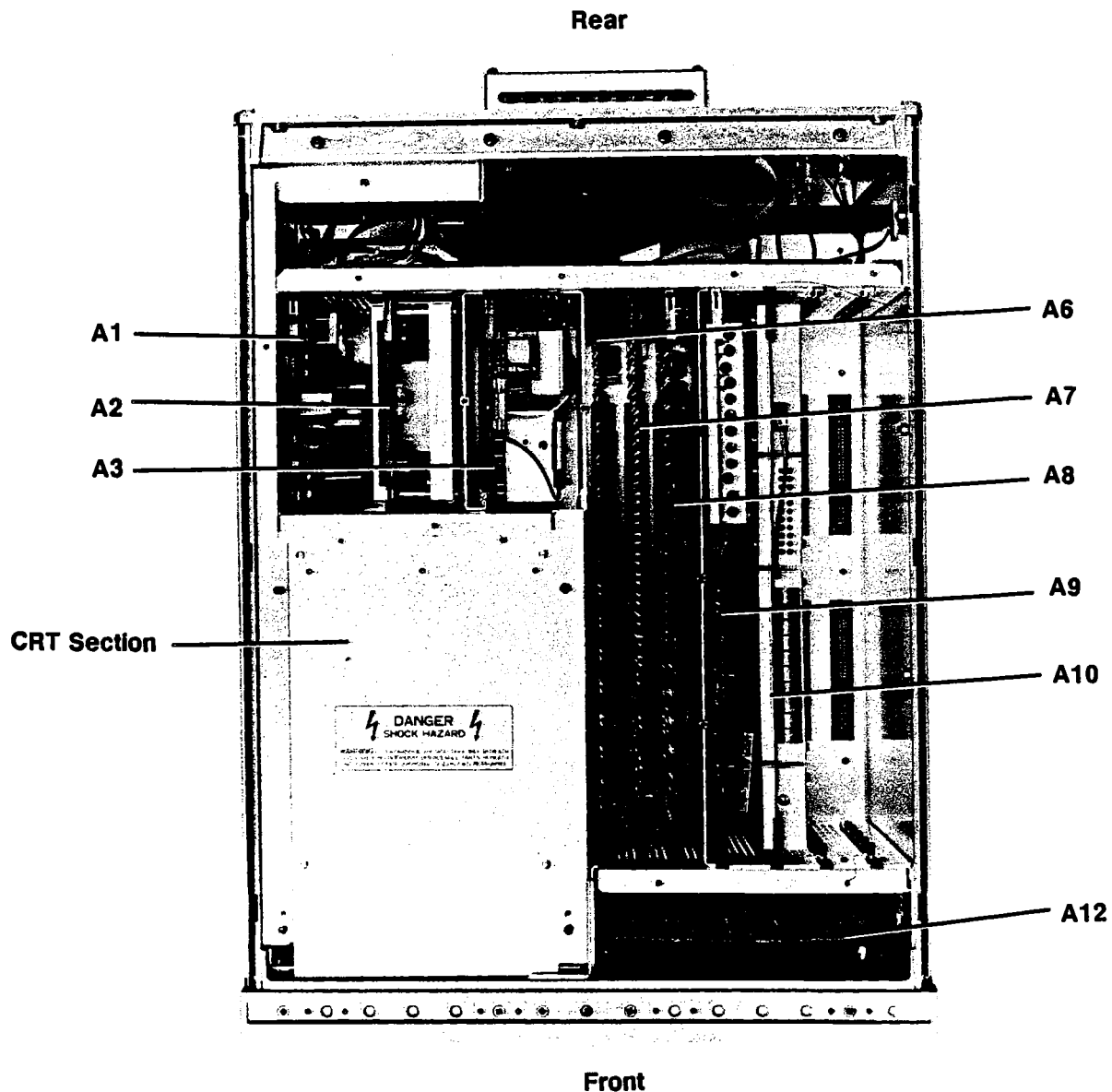

WARNING

CAPACITORS ON THE A1 BOARD REMAIN CHARGED WITH HAZARDOUS VOLTAGES FOR A PERIOD OF TIME AFTER THE INSTRUMENT IS TURNED OFF. ALLOW AT LEAST TWO MINUTES FOR THE CAPACITORS TO DISCHARGE AFTER THE INSTRUMENT IS TURNED OFF. (LEDS A1DS1 AND DS2 SHOW THAT DANGEROUS ENERGY REMAINS IN CAPACITORS ON A1 BOARD.)

CRT SECTION TOP VIEW

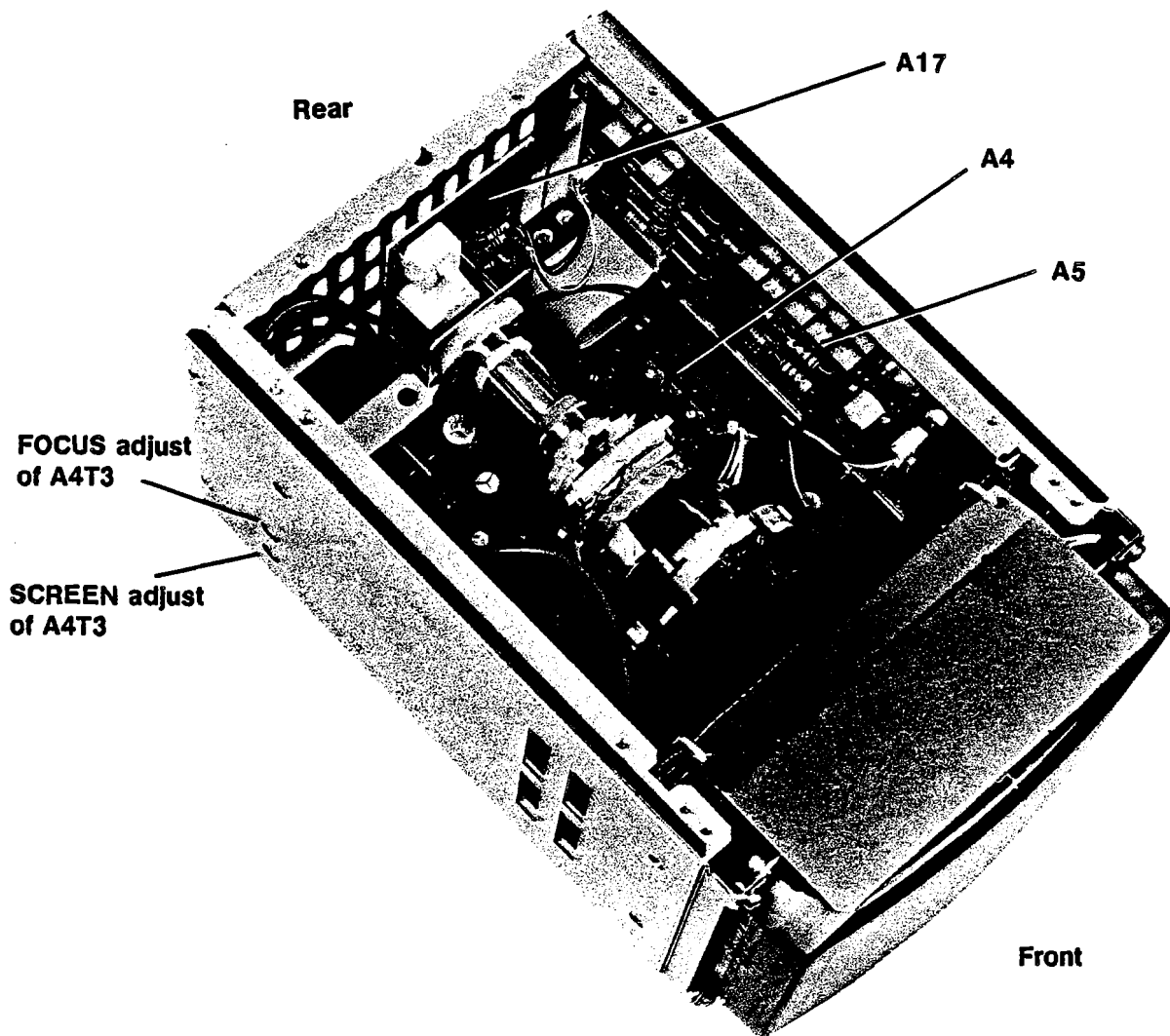

WARNING

HAZARDOUS VOLTAGE (16 kV MAX EXISTS IN THE CRT SECTION.)

MEASUREMENT UNIT (LOWER UNIT) TOP VIEW

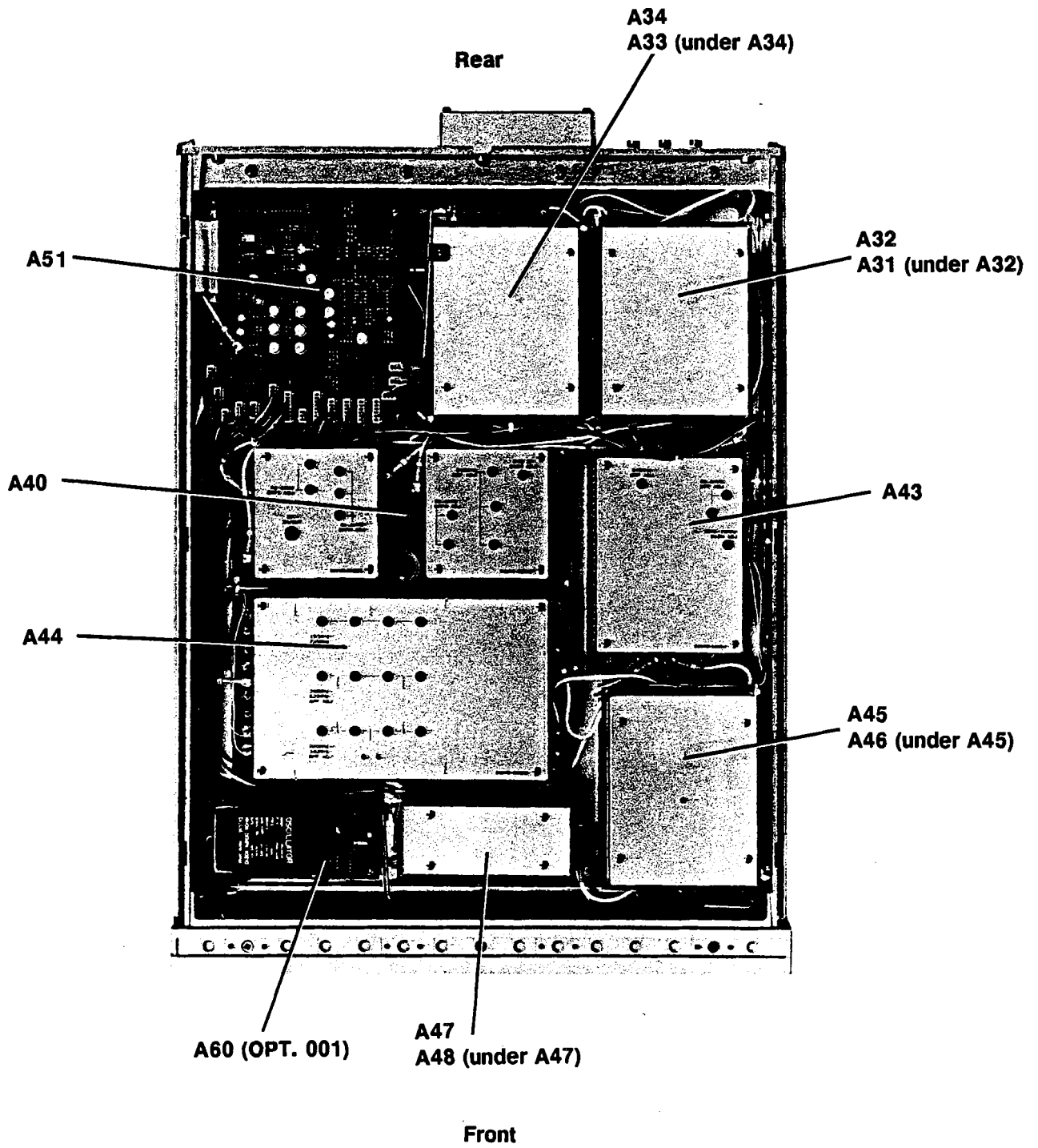

MEASUREMENT UNIT (LOWER UNIT) BOTTOM VIEW

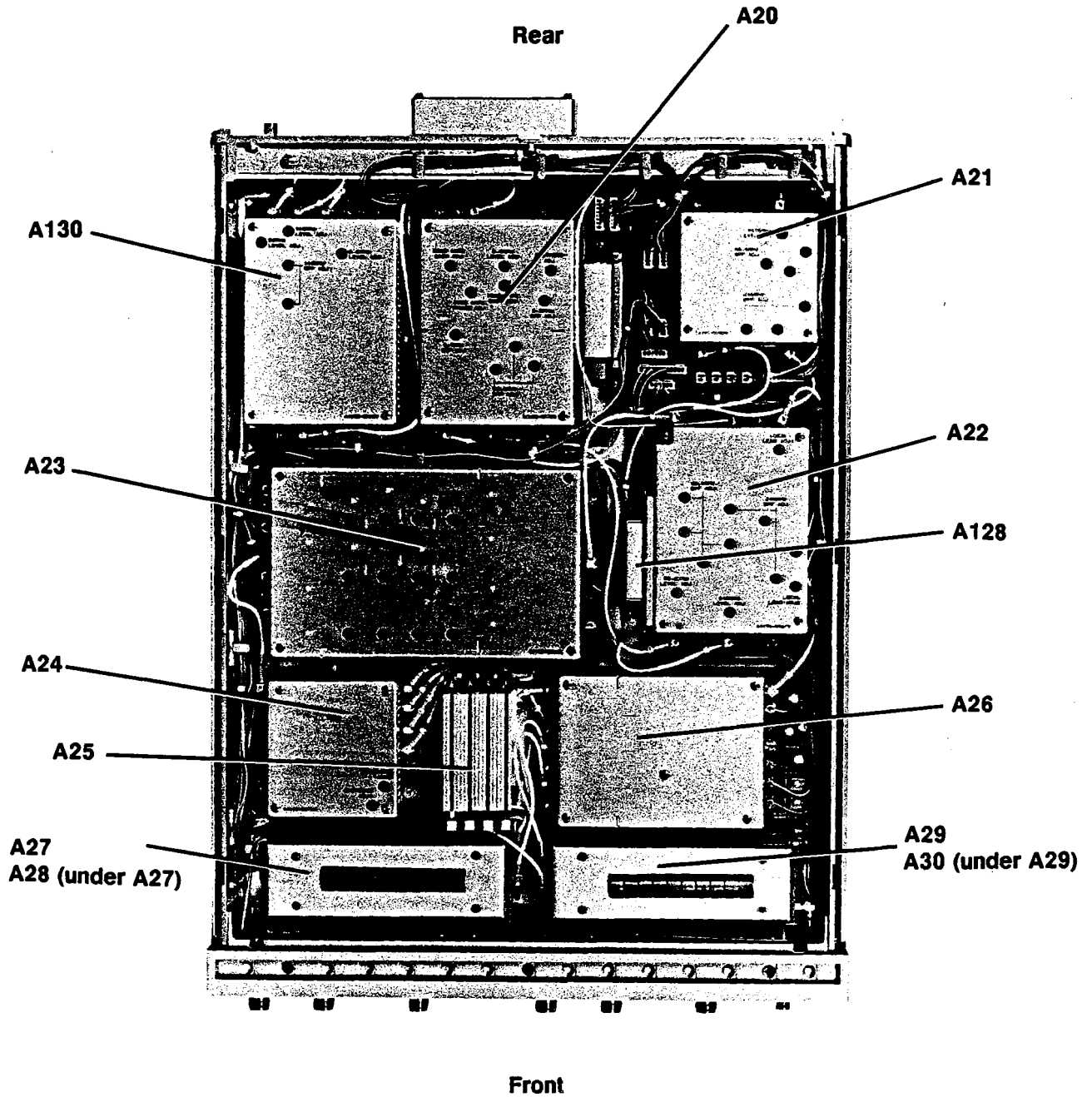

ATTENUATOR RELAYS



Subminiature High Frequency Polarized Relays

■ FEATURES

- Subminiature Polarized Relay
- Excellent High Frequency Characteristics
 - Isolation : min. 60 dB
 - Insertion loss: max. 1 dB
 - V.S.W.R. : max. 1.2
- High Reliability - Bifurcated Contacts
- Wide Operating Range
- DIL Pitch Terminals
- Washable Type Backfilled with Nitrogen
- Latching Version Available

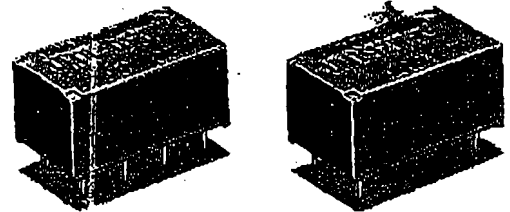

■ STRUCTURE

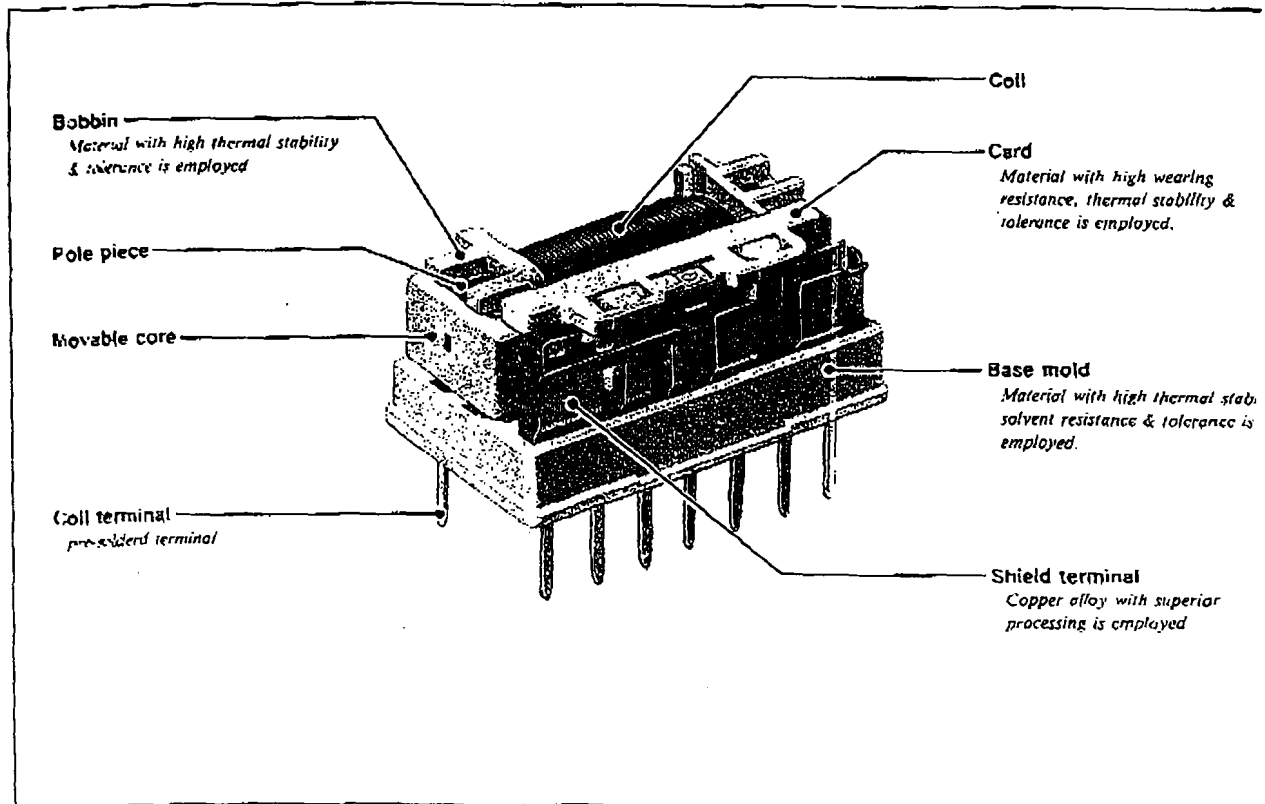

UM1 Relay

■ SPECIFICATIONS

CONTACT

- Arrangement..... 1 Form C (SPDT)
- Material
 - Stationary..... Gold clad
 - Movable..... Gold plate
- Type..... Bifurcated Type
- Resistance (initial)..... Max. 100 mΩ
- Ratings (resistive)
 - Nominal Load..... 10mA 24VDC, 1W (900MHz)
 - Max. Switching Power..... 1W (DC), 10W (900MHz)
 - Max. Switching Voltage..... 30 VDC
 - Max. Switching Current..... 100mA
 - Max. Carrying Current..... 0.5A
 - Min. Switching Load(*1)..... 10mVDC 0.01mA
- Life Expectancy
 - Mechanical..... 1 x 10⁶ operations
 - Electrical..... 3 x 10⁵ operations (at nominal load)

COIL

- Nominal Voltage..... 1.5 to 48 VDC
- Nominal Power (at 20°C)..... UM1, UM1L : 200mW
UM1L-D : 400mW
- Operate Power (at 20°C)..... UM1, UM1L : 100mW
UM1L-D : 200mW
- Operate & Release Voltage..... Please see Coil Data Chart
- Max. Continuous Voltage..... Please see Characteristic Data

GENERAL

- Insulation Resistance..... Min. 1,000MΩ at 500VDC
- Dielectric Strength..... 500VAC 1 minute
(between open contacts, between contacts & shield terminals)
1,000VAC 1 minute
(between coil and contacts, between coil and shield terminals)
- Temperature Range..... UM1, UM1L : -30° to +80°C
(at nominal voltage) UM1L-D : -30° to +60°C
- Time Value..... UM1 : Operate : Max. 6ms
(at nominal voltage) Release : Max. 5ms
UM1L, UM1L-D : Set & Reset : Max. 6ms
- Vibration Resistance
 - Misoperation..... 10 to 55Hz,
double amplitude of 3.3mm
 - Endurance..... 10 to 55 Hz,
double amplitude of 5mm
- Shock Resistance
 - Misoperation..... 500m/s² (11±1ms)
 - Endurance..... 1,000m/s² (6±1 ms)
- Unit Weight..... Approx. 4 g
- Enclosure..... Polybutylene Terephthalate (PBT)

(*1) Min. Switching Load mentioned above is reference value. Please perform the confirmation test with the actual load before production since reference values may vary according to switching frequency, environmental conditions and expected reliability levels.

■ ORDERING INFORMATION

UM1L-D12W-K

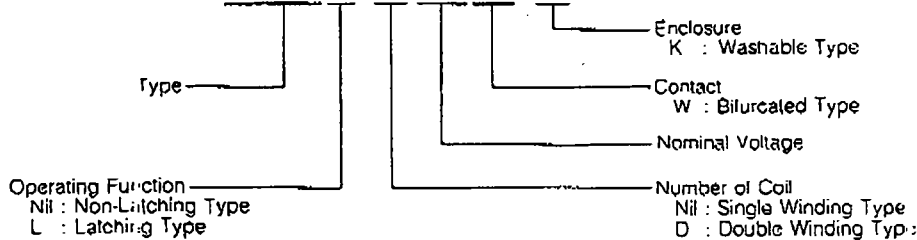

■ COIL DATA CHART

UM1 Type

ORDERING CODE	Coil Nominal Voltage V DC	Coil Resistance Ω ±10% (at 20°C)	Must Operate Voltage (*1) V DC (at 20°C)	Must Release Voltage (*1) V DC (at 20°C)	Coil Nominal Power mW (at 20°C)	
Non-Latching Type	UM1- 1.5W-K	1.5	+ 11.2	+ 1.05	+ 0.08	200
	UM1- 3 W-K	3	45	+ 2.1	+ 0.15	200
	UM1- 4.5W-K	4.5	101	+ 3.15	+ 0.23	200
	UM1- 5 W-K	5	125	+ 3.5	+ 0.25	200
	UM1- 6 W-K	6	180	+ 4.2	+ 0.3	200
	UM1- 9 W-K	9	405	+ 6.3	+ 0.45	200
	UM1-12 W-K	12	720	+ 8.4	+ 0.6	200
	UM1-18 W-K	18	1,620	+12.6	+ 0.9	200
	UM1-24 W-K	24	2,880	+16.8	+ 1.2	200
	UM1-48 W-K	48	10,472	+33.6	+ 2.4	200

Note) (*1) Specific I value are subject to square wave voltage.



UM1L, UM1L-D Type

ORDERING CODE		Coil Nominal Voltage V DC	Coil Resistance $\Omega \pm 10\%$ (at 20°C)	Must Operate Voltage (*1) V DC (at 20°C)	Must Release Voltage (*1) V DC (at 20°C)	Coil Nominal Power mW (at 20°C)
Single Winding Latching Type	UM1L-1.5W-K	1.5	11.2	+ 1.05	- 1.05	200
	UM1L-3 W-K	3	45	+ 2.1	- 2.1	200
	UM1L-4.5W-K	4.5	101	+ 3.15	- 3.15	200
	UM1L-5 W-K	5	125	+ 3.5	- 3.5	200
	UM1L-6 W-K	6	180	+ 4.2	- 4.2	200
	UM1L-9 W-K	9	405	+ 6.3	- 6.3	200
	UM1L-12 W-K	12	720	+ 8.4	- 8.4	200
	UM1L-18 W-K	18	1,620	+12.6	-12.6	200
	UM1L-24 W-K	24	2,880	+16.8	-16.8	200
	UM1L-48 W-K	48	11,520	+33.6	-33.6	200
Double Winding Latching Type	UM1L-D 1.5W-K	1.5	P 5.8 S 5.6	+ 1.05	+ 1.05	400
	UM1L-D 3 W-K	3	P 22.5 S 22.5	+ 2.1	+ 2.1	400
	UM1L-D 4.5W-K	4.5	P 50.6 S 50.6	+ 3.15	+ 3.15	400
	UM1L-D 5 W-K	5	P 62.5 S 62.5	+ 3.5	+ 3.5	400
	UM1L-D 6 W-K	6	P 90 S 90	+ 4.2	+ 4.2	400
	UM1L-D 9 W-K	9	P 202.5 S 202.5	+ 6.3	+ 6.3	400
	UM1L-D12 W-K	12	P 360 S 360	+ 8.4	+ 8.4	400
	UM1L-D18 W-K	18	P 810 S 810	+12.6	+12.6	400
	UM1L-D24 W-K	24	P 1,440 S 1,440	+16.8	+16.8	400
	UM1L-D48 W-K	48	P 5,760 S 5,760	+33.6	+33.6	400

Note) (*1) Specified value are subject to square wave voltage.

P: Primary coil S: Secondary

CHARACTERISTIC DATA

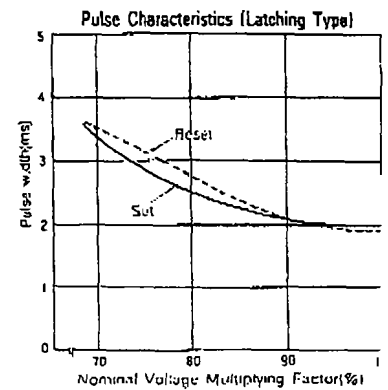
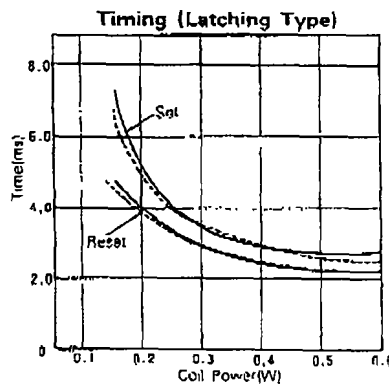
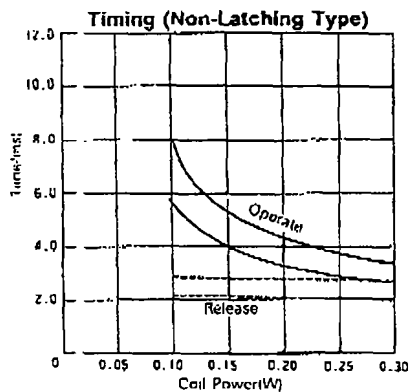

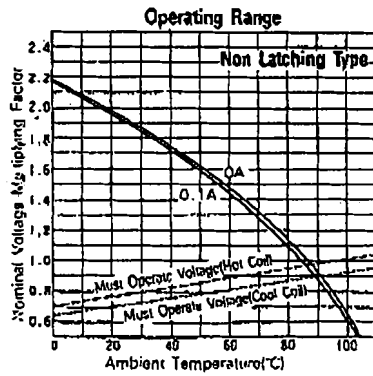
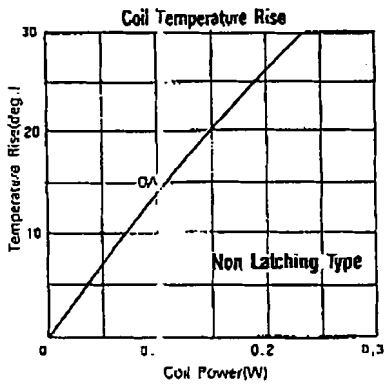

■ REFERENCE DATA

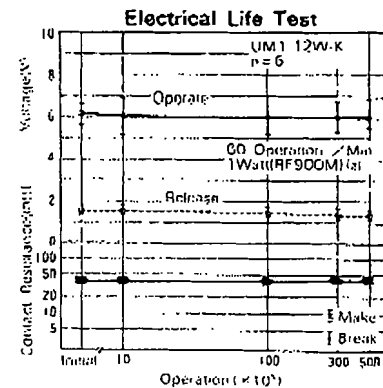
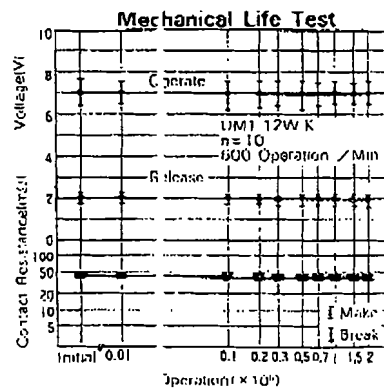
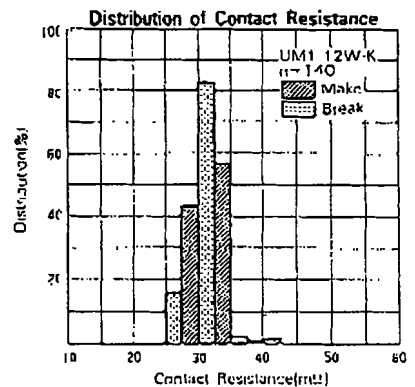
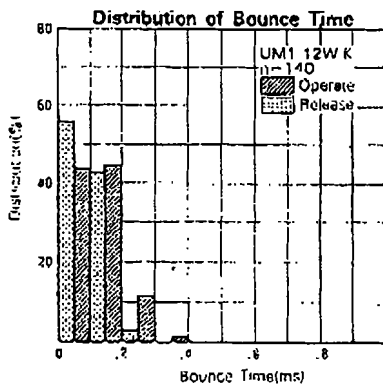
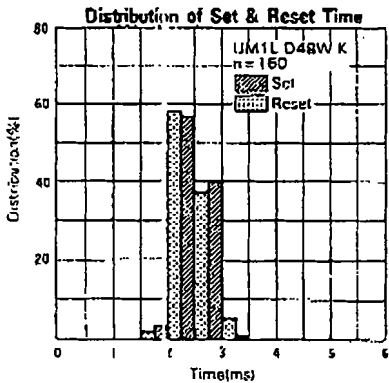
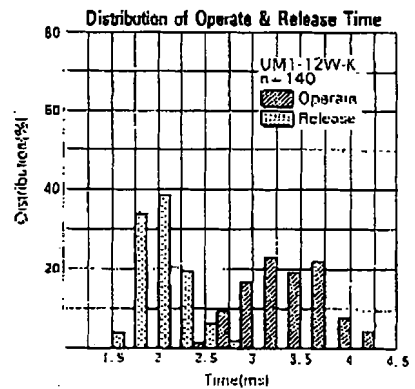
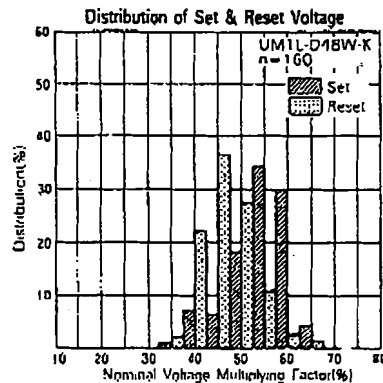
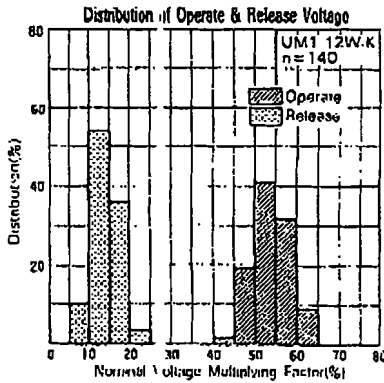

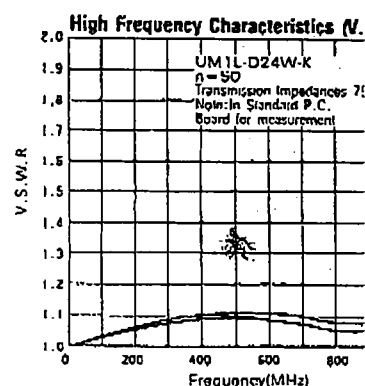
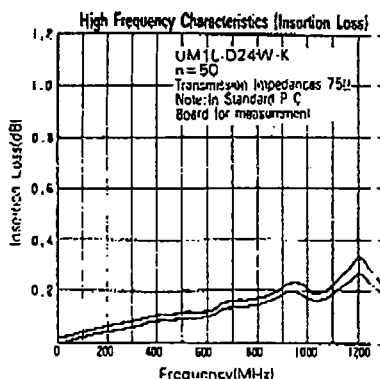
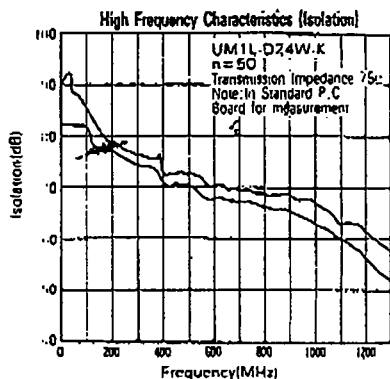

■ DIMENSIONS (in mm)

■ WIRING DIAGRAM (BOTTOM VIEW)

■ DRILLING PLAN (BOTTOM VIEW)

UM1, UMIL Type (Non-Latching Type, Single Winding Latching Type)

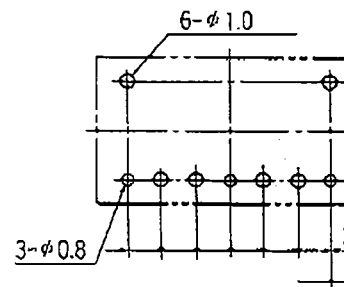
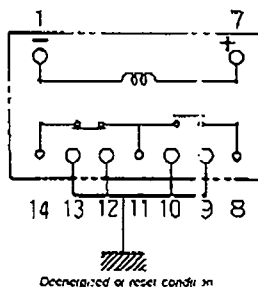
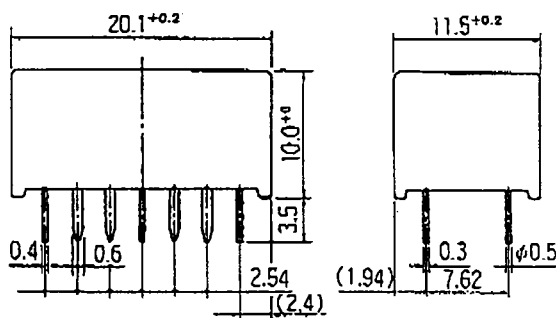

UMIL-D Type (Double Winding latching Type)

